

STATE OF CALIFORNIA  
MARINE RESEARCH COMMITTEE

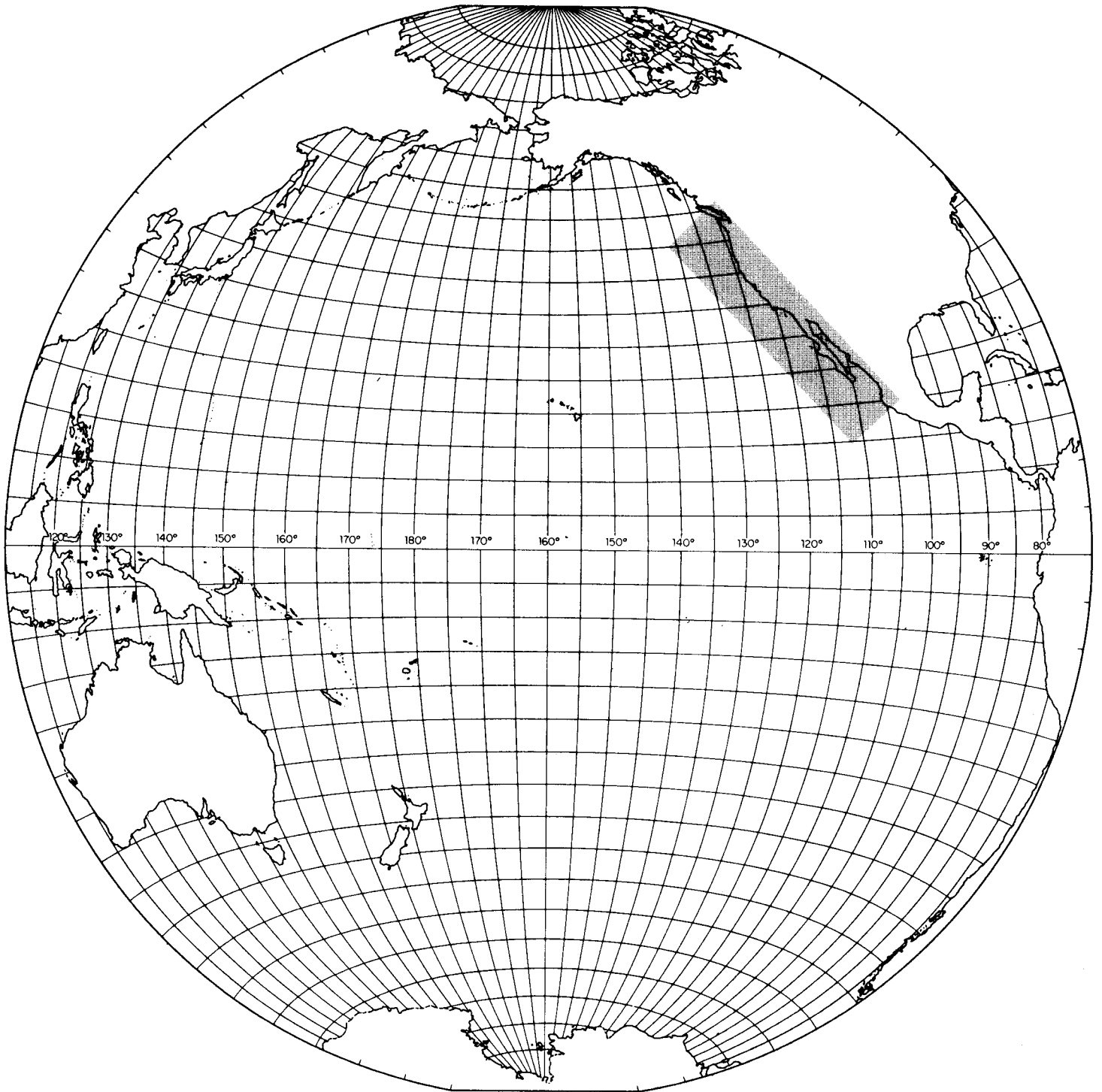

# CALIFORNIA COOPERATIVE OCEANIC FISHERIES INVESTIGATIONS

REPORTS

VOLUME

XVIII

MAY

1976

This report is not copyrighted and may be reproduced in other publications provided due credit is given the California Marine Research Committee, the author, and the reporting agencies. Inquiries concerning this report should be addressed to the State Fisheries Laboratory, California Department of Fish and Game, 350 Golden Shore, Long Beach, California 90802.

**EDITORIAL BOARD**

**Herbert W. Frey  
John Radovich  
Joseph L. Reid  
Brian J. Rothschild**

**CODEN COFR-A**

STATE OF CALIFORNIA  
DEPARTMENT OF FISH AND GAME  
MARINE RESEARCH COMMITTEE

CALIFORNIA  
COOPERATIVE  
OCEANIC  
FISHERIES  
INVESTIGATIONS

*Reports*

VOLUME XVIII

1 July 1973 to 30 June 1975

Cooperating Agencies:

CALIFORNIA ACADEMY OF SCIENCES  
CALIFORNIA DEPARTMENT OF FISH AND GAME  
STANFORD UNIVERSITY, HOPKINS MARINE STATION  
UNIVERSITY OF CALIFORNIA, SCRIPPS INSTITUTION OF OCEANOGRAPHY  
NATIONAL OCEANIC AND ATMOSPHERIC ADMINISTRATION, NATIONAL MARINE  
FISHERIES SERVICE

1 May 1976

DEPARTMENT OF FISH AND GAME

## MARINE RESEARCH COMMITTEE



1 October 1976

The Honorable Edmund G. Brown Jr.  
*Governor of the State of California*  
*Sacramento, California*

Dear Governor Brown:

We have the honor to submit the eighteenth report of the California Cooperative Oceanic Fisheries Investigations.

The report consists of four sections. The first contains a review of the administrative and research activities during the period 1 July 1973 to 30 June 1975, a description of the fisheries, and a list of publications arising from the programs.

The second section consists of papers presented at two symposia, "Fishery science: fact, fiction, and dogma" and "Oceanography and fisheries of Baja California waters," held in November 1973. This section also includes several papers pertinent to the living marine resources of California. Participants in the symposia included key members of the scientific community in California as well as scientists of the Instituto Nacional de Pesca of Mexico and the Unidad de Ciencias Marinas, Universidad Autonoma de Baja California.

The third section consists of papers presented at a symposium held in November 1974 which brought together members of the scientific communities and government agencies of California and Mexico. Participants in the symposium provided new insight to some fundamental biological and oceanographic problems.

The fourth section consists of a scientific contribution that represents research directly pertinent to the living marine resources of California.

Respectfully submitted,

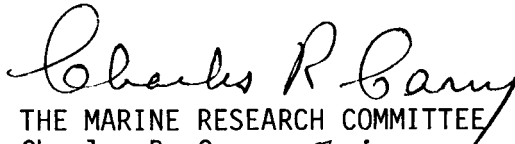
  
THE MARINE RESEARCH COMMITTEE  
Charles R. Carry, *Chairman*



## CONTENTS

I. Review of Activities of 1 July 1973 to 30 June 1975.....	5
Report of the CalCOFI Committee.....	5
Agency Reports.....	6
Review of the Pelagic Wet Fisheries for 1973 and 1974.....	21
Publications .....	23
II. Symposia of the CalCOFI Conference	
San Clemente, November 4-7, 1973	
A. Fishery Science: Fact, Fiction, and Dogma.	
Catch-per-Unit-of-Effort: Fact, Fiction, and Dogma. <i>John Radovich</i> .....	31
Fishery Science: Fact, Fiction, and Dogma. <i>John D. Isaacs</i> .....	34
Fishery Science: Fact, Fiction, and Dogma. <i>Brian J. Rothschild</i> .....	44
Panel Discussion. <i>Herbert W. Frey</i> moderator, <i>John D. Isaacs, John Radovich, and Brian J. Rothschild</i> , panel members.....	45
B. Oceanography and Fisheries of Baja California Waters.	
Hidrología del Alto Golfo de California—I. Condiciones Durante Otoño. <i>Saúl Alvarez Borrego and Luis Arnulfo Galindo Bect</i> .....	51
Hidrología de la Bahía de San Quintín, Baja California, en Invierno y Primavera. <i>Amelia Guadalupe Chávez de Nishikawa and Saúl Alvarez Borrego</i> .....	60
Concentración de DDT y sus Metabolitos en Especies Filtroalimentadores y Sedimentos en el Valle de Mexicali y Alto Golfo de California. <i>J. Guardado Puentes</i> .....	73
Elementos Sobre la Distribución de Turbidez en el Alto Golfo de California. <i>Guadalupe Garcia de Ballesteros and Michel Larroque</i> .....	81
C. Scientific Contributions	
On Biology of the Market Squid, <i>Loligo opalescens</i> , a Contribution Toward the Knowledge of Its Food Habits and Feeding Behavior. <i>Anatole S. Loukashkin</i> .....	109
Deep Scattering Layers: Patterns in the Pacific. <i>Sargun A. Tont</i> .....	112
Benthic Oceanography and the Distribution of Bottom Fish Off Los Angeles. <i>Alan J. Mearns and Lucinda Smith</i> .....	118
III. Symposia of the Cal COFI Conference	
Santa Barbara, November 12-14, 1974	
Roles of Phytoplankton in Marine Food Webs. <i>Richard W. Eppley</i> .....	125
An Experimentalist's View of Zooplankton Models. <i>Michael M. Mullin</i> ..	132
Density Dependence of Catchability Coefficient in the California Pacific Sardine, <i>Sardinops sagax caerulea</i> , Purse Seine Fishery. <i>Alec D. MacCall</i> .....	136
Sonar Mapping in the California Current Area: A Review of Recent Developments. <i>Rodger Hewitt</i> .....	149
California Undercurrent in the Southern California Bight. <i>Mizuki Tsuchiya</i> .....	155
Sediment Trap Applications in the Nearshore Region. <i>Floyd K. Mitchell</i>	159
Trace Element Anomalies in Marine Organisms off Southern California. <i>David R. Young and Dierdre J. McDermott</i> .....	162
Report of Neuston (Surface) Collections Made on an Extended CalCOFI Cruise During May 1972. <i>Elbert H. Ahlstrom and Elizabeth Stevens</i>	167
IV. Scientific Contributions	
Ovarian Development and Fecundity of Five Species of California Current Fishes. <i>John S. MacGregor</i> .....	181



Part I

## REVIEW OF ACTIVITIES

1 July 1973 to 30 June 1975

### REPORT OF THE CALCOFI COMMITTEE

Many of the CalCOFI data collecting programs have been in existence for over 25 years. The information gathered by these programs represents some of the most extended time series of oceanographic, biological, and fisheries data in existence. During the period covered by this report, a considerable effort was made to analyze the interrelationships of some of these series of data. A better understanding of some of the fishery resources and oceanographic conditions has resulted from this effort.

During the last 2 years, the informal cooperative research activities between various CalCOFI agencies and the Instituto Nacional de Pesca (INP) of Mexico have continued and in many cases have been enhanced. CalCOFI/INP meetings have been held on a semi-annual basis and there has been a

number of "working group" meetings on various aspects of cooperative oceanographic and fisheries research. Researchers of the Escuela Superior de Ciencias Marinas of the Universidad Autonoma de Baja California also continued cooperative research projects with CalCOFI scientists. Some of these cooperative activities have resulted in papers that have been contributed for publication in this volume.

These cooperative research programs with Mexico assume more importance as that country increases its harvest of fish species that occur off the coast of California and Baja California. Data gathered by these programs may form the basis for managing these living marine resources. *Herbert W. Frey, John Radovich, Joseph Reid, and Brian Rothschild.*

## AGENCY REPORTS

### CALIFORNIA ACADEMY OF SCIENCES

July 1, 1973, to June 30, 1974

During this fiscal year, investigations have continued on market squid and on species of fish previously under investigation. It was originally postulated that about 1000 specimens of each species, with a reasonable geographic distribution within its range, would be necessary to establish a pattern of feeding. This however did not take account of the fact, later discovered, that in a considerable number of cases the stomachs are found completely empty, and thus yield no information at all. It is necessary, therefore, to alter this objective to numbers of stomachs containing food. It should be noted also that consistency of feeding patterns among a substantial number of specimens from different localities and at different seasons is more important than analyzing the stomach contents of a large number of specimens from one locality, or at one period of the year.

Study and identification of stomach contents were made by Anatole Loukashkin.

*Market Squid.* Stomachs of market squid, *Loligo opalescens*, from Monterey Bay collected in June 1973, were examined and the contents recorded as follows: 87 stomachs (46%) contained food or food remains. Among three dominant items, crustacean remains occupied first place, polychaetes second place, and fish remains third.

*Hake.* From the same area, taken at the same time, 70 stomachs of the Pacific hake were examined. 57 stomachs (74.3%) contained food. Of this, 77% consisted of euphausiid crustaceans and their parts, 11.5% lantern fish, 3.8% squid, 1.9% sergestid shrimps.

Forty-six stomachs of Pacific hake collected by Kenneth Mais from the Channel Islands off southern California were examined. Of these, 42 stomachs were filled with food, of which 91.5% consisted of euphausiids and their remains, and miscellaneous material (unidentifiable) 4.7%.

*Saury.* A collection of 100 frozen Pacific saury from central California waters, made in 1972, was received from Kenneth Mais in October 1973. Of these, almost all contained food, ranging from full to about  $\frac{1}{2}$  capacity. Two stomachs were empty.

The identifiable food items found consisted, in the order named, of crustacean flesh and fragments, hyperid amphipods, crustacean larvae (mostly megalopa larvae of crabs), fish remains, euphausiids, jellyfish and parts of same, and one isopod. There was a considerable amount of unidentifiable fleshy material, probably of crustaceans and/or fish. It is noteworthy that no phytoplankton was found.

*Anchovy.* A collection of 427 stomachs of northern anchovy taken in central California waters

by Jerome Spratt in May-June 1973, were studied early in 1974. One hundred eighty-nine stomachs were filled with copepods of several species as the dominant food item. The remaining 238 stomachs were filled exclusively with diatoms—*Chaetoceros*, *Skeletonema*, *Coscinodiscus*, *Rhizosolenia*, and others.

During the period November 15-30, 1973, Loukashkin participated in a research cruise of the ALASKA for observation of feeding behavior and collection of market squid and fishes assigned to the program by the Marine Research Committee. In cooperation with Raymond Ally of the Department of Fish and Game, 159 squid, 42 jack mackerel, and 58 saury were collected. The weather was stormy and collecting difficult.

Robert C. Miller

### CALIFORNIA ACADEMY OF SCIENCES

July 1, 1974-June 30, 1975

Investigations in 1974-75 have been largely a continuation of those of the preceding fiscal year, as additional material has become available.

*Market Squid.* One hundred fifty-nine stomachs of market squid, *Loligo opalescens*, from the Channel Islands region, were collected by Raymond Ally and Anatole Loukashkin in November 1973. Eighty-eight stomachs (55.3%) contained food, while 71 (44.7%) were empty. Quantities of food in stomachs varied from full to less than  $\frac{1}{2}$  of stomach capacity. Dominant identifiable food items were crustacean remains (25%), polychaete remains (24%), fish remains (17%), and euphausiids (1%). The remainder consisted of indeterminable fleshy material.

Of 143 stomachs of market squid collected by Raymond Ally in central and southern California waters in June 1974, 72 stomachs contained food and 71 were empty; 22 stomachs were filled to capacity, and 50 contained food in amounts from  $\frac{1}{4}$  capacity to less than  $\frac{1}{2}$ . Dominant food items were fish remains (41.6%) crustacean remains (45.7%) polychaetes (8.4%) and young squid remains (6.9%). The remainder consisted of indeterminate fleshy material.

*Saury.* Fifty-eight stomachs of saury collected by Ally in the Channel Islands area in November 1973 (from the same area and season as the squid mentioned above) were examined. Of these 45 contained food in small amounts ( $\frac{1}{2}$  or less of stomach capacity). Dominant forms were siphonophores and their remains, copepod remains, 12 pteropods (intact), and small amounts of fish remains, crustacean fragments and eggs, euphausiid remains, polychaete remains, and amphipods, along with a certain amount of indeterminate material

(unidentifiable because of the advanced state of digestion).

*Anchovy.* Four hundred anchovy stomachs were examined (the remainder of those obtained by Jerome Spratt in central California waters in May-June 1973). As in those previously examined from this area at this season, phytoplankton was predominant, with copepods taking second place. Among diatoms the most abundant forms were *Skeletonema costata*, *Rhizosolenia* sp., *Melosira varians*, *Ditylum* sp., *Navicula* sp., *Nitzschia* sp., *Thalassiosira* sp., *Chaetoceros curvisetus* and *C. affine*. A few protozoa that leave visible remains were noted (Coccolithophoridae and a possibly amoeboid form resembling *Arcella*).

The unexpected dominance of phytoplankton in this sampling bears out the necessity of obtaining numbers of specimens from as many areas and seasons as possible in order to determine the total spectrum of feeding in a given species of fish.

*Pacific and Jack Mackerel.* We now have records of stomach contents of 1092 specimens of Pacific and 792 specimens of jack mackerel, including some 200 specimens of each obtained by Loukashkin on voyages in Mexican waters in 1958, 1961, and 1962. It would be desirable to have 200 or 300 more jack mackerel from California waters in order to write up for publication the data on food of these species.

Robert C. Miller

## CALIFORNIA DEPARTMENT OF FISH AND GAME

July 1, 1973, to June 30, 1974

The Marine Resources Region underwent reorganization during the latter part of this period. The purpose of this action was to separate management and research activities. Management responsibilities remained with the Marine Resources Region while the major research responsibilities were transferred to Operations Research Branch. Since the Pelagic Fish Program was involved in both activities, the Sea Survey and Fisheries Monitoring Projects remained in Marine Resources Region while the Biological Studies and Data Analysis Projects were placed in Operations Research Branch.

In 1972, the California State Legislature passed a management bill that requires a moratorium on the commercial take of Pacific mackerel until the spawning biomass between Point Conception, California, and Punta Eugenia, Baja California, reaches 10,000 tons. This tonnage estimate is to be determined by the California Department of Fish and Game. Similar legislation was passed in 1973 for managing Pacific sardines. A moratorium on this fishery became effective January 1, 1974, and will remain in effect until the spawning biomass north of Cape Colnett, Baja California, reaches 20,000 tons. Legislation also was passed in 1973 directing the department to conduct a 2 year study as a basis for

managing Pacific herring stocks in Tomales and San Francisco Bays.

### Sea Survey

Nine sea survey cruises were conducted during the year. The anchovy resources of northern Baja California and southern California were acoustically surveyed on four cruises, and those of central California during one cruise. Nearly 5,600 nautical miles of echo ranging and sounding were completed. Two cruises were devoted to developing methods of estimating anchovy school biomass from acoustic records. An exploratory survey for market squid was made in central California, and a survey was made using night-light and blanket net to monitor Pacific mackerel and Pacific sardine populations in southern California waters.

The increase in the anchovy population off northern Baja California and southern California, as indicated by acoustic surveys in 1972, has continued through 1973. Surveys this year indicate a larger population than at any time since acoustic surveys were initiated in 1966. Very conservative estimates of biomass for this region range from 1.7 to 2.5 million tons. Highly successful recruitment during 1973 should result in a continued increase.

Progress was made toward more accurate assessment of anchovy school biomass which is the key to more accurate estimations of population size. Target strength, volume back scattering strength measurements, and simultaneous underwater visual observations have added to our knowledge of acoustically assessing school sizes and densities.

### Data Analysis

Several different methods of determining Pacific mackerel population size were investigated as mechanisms for estimating the spawning population size of Pacific mackerel stocks north of Punta Eugenia, Baja California. The estimate of Pacific mackerel spawning population size obtained by a tagging procedure was 5,480 tons. Three additional methods were used to estimate spawning biomass. These estimates were 4,730 tons, 6,210 tons, 6,970 tons. All of these estimates were less than the 10,000 tons required to initiate a commercial fishery under the Pacific mackerel management regulation (Section 8388.5 of the California Fish and Game Code).

Analysis of Pacific mackerel maturation and growth data reveals spawning can occur from March through October, but the majority takes place from April through August. During this April through August period, 22.5%, 65.5%, 75.1%, 84.7%, 84.2%, and 87.5% of the female fish were mature or maturing for Age Groups I, II, III, IV, V, and VI+ respectively.

Examination of past Pacific mackerel data and estimated parameters has raised serious doubts about the reliability of historical estimates.

Analysis of 18 years of the jack mackerel cannery fishery has shown an almost 10 to 1 variability in year class strengths occurring in the past.

Intensive investigations of sardine data for population estimates were initiated with the passage of the sardine management bill.

#### *Mackerel Tagging Program*

The Mackerel Tagging Program was initiated in August 1971 under contract with the Marine Research Committee. By the end of 1972, program personnel had tagged 11,215 jack mackerel and 1,898 Pacific mackerel. During 1973, a total of 4,640 jack mackerel and 1,509 Pacific mackerel was tagged. These fish were tagged and released from Departmental research vessels and cooperating commercial fishing vessels in the San Pedro purse seine fleet. Additional fish have been supplied by local southern California live bait operators.

Tagged fish have been recovered at a rate of 1% for jack mackerel and 3.75% for Pacific mackerel. Jack mackerel recoveries primarily come from cannery personnel while tagged Pacific mackerel are most frequently returned by sportsmen. Tag return data from the jack mackerel are being utilized to chart the inshore movements of the population off southern California and to supplement electrophoretic, morphometric, and meristic data concerning the racial characteristics of this stock.

Tag and recovery data from the Pacific mackerel are used in estimating the spawning biomass of this species between Punta Eugenia, Baja California, and Point Conception.

*Herbert W. Frey*

### CALIFORNIA DEPARTMENT OF FISH AND GAME

July 1, 1974, to June 30, 1975

#### *Sea Survey*

Acoustic surveys indicated a slight decrease in the anchovy population over the record high of 1973. Spring and fall surveys found fewer schools and a more patchy, less widespread distribution than the previous year. The bulk of the population was located in the northern half of southern California where large concentrations and high availability produced good fishing.

A cooperative purse seiner charter cruise with National Marine Fisheries Service and operation of our sonar in conjunction with purse seine fishing operations have greatly improved our capabilities to estimate anchovy school biomass from acoustic records. Underwater photography of anchovy schools also has enhanced this capability. Results of this work indicate we have been making reasonably accurate estimates of schools up to 25 tons and underestimating the larger ones.

An anchovy acoustic survey of northern Baja California and southern California in February 1975

detected a total of 10,527 anchovy schools over 1,671 miles of transects.

A new program for the Wang desk computer enable us to produce biomass estimates by 20 minute grids within 1 week of cruise completion.

The most successful Pacific mackerel spawning in more than 7 years was indicated by relatively numerous catches of young fish by midwater trawling and night-lighting in southern California young mackerel were received from bait haulers and scuba divers. No evidence of change in the depressed condition of the sardine population was detected by sea surveys. Unusually large concentrations of Pacific sauries were present in the offshore areas of southern California during the fall of 1974. This is the largest and most extensive concentration seen in this area in the last 10 years.

#### *Pacific Herring Studies*

In 1972, Japan removed their import quota on herring roe. This action immediately established a lucrative market for Pacific herring in California. Consequently a resurgence of the herring fishery developed in California in 1973. This fishery is conducted primarily in San Francisco and Tomales Bays, and just-ready-to-spawn fish are the targets. Nearly all of the catch is frozen and exported, ultimately reaching the specialty markets in Japan.

As a result of this harvest of spawning herring for the production of "kazamoko," the department was requested by the California State Legislature to carry out a 2 year study on the Pacific herring resources in San Francisco and Tomales Bays. The study was conducted during the 1973-74 and 1974-75 spawning seasons, and was designed to (1) estimate the spawning biomass of herring in Tomales and San Francisco Bays; (2) determine if Tomales Bay and San Francisco Bay contain separate stocks; and (3) determine size, age, and sex composition of the landings.

The study indicated that current spawning populations of Pacific herring in San Francisco and Tomales Bays are larger than prior estimates indicated. Spawning biomass in San Francisco Bay is estimated at nearly 20,000 tons while that in Tomales Bay approximated 5,000 to 6,000 tons.

A comparison of sampling data from the two bays indicates each contains a spawning population that is not freely interbreeding.

Analysis of age-length data indicates a difference in mean length at age exists between Tomales Bay and San Francisco Bay herring. In 1973-74 Tomales Bay age classes were from 4 to 14 mm SL larger than corresponding age classes from San Francisco Bay. In 1974-75 Tomales Bay age classes were again larger by 3-11 mm SL. The fact that Tomales Bay herring are consistently larger at every age group is strong indication that herring from Tomales and San Francisco Bays are not freely interbreeding. Except during the short spawning season, the herring

population from both bays probably occupies the same area of the Pacific Ocean off California. The fish feed and grow in the same areas and their total environment may be considered the same once they leave the bays. It is unlikely that environmental factors in the ocean, except for spawning, would favor herring from Tomales Bay over herring from San Francisco Bay. The faster growth exhibited by Tomales Bay herring probably is genetic in origin.

The overall age composition of both bays is comparable with 2, 3, and 4 year old fish combined accounting for 68% to 80% of the catch during the study.

### **Market Squid Study**

In order to facilitate an expanding harvest of *Loligo opalescens* and provide a scientific basis for its management, a study was initiated in 1974 on the market squid. This is a cooperative California Department of Fish and Game and Sea Grant program. The goals of the program are to assist management agencies and the fishing industry in:

- 1) Devising methods for increased harvest of squid, including improved gear, better knowledge of squid spawning areas, and correlation of oceanographic conditions with the appearance of squid on the spawning grounds.
- 2) Determining acceptable levels of harvest to insure that squid are utilized on a sustained yield basis by developing techniques for assessing the size of the population and investigating the possibility that this population is divided into reproductively isolated subpopulation, stocks, or races. This work includes ascertaining the age at which market squid mature sexually and the number of times they are capable of reproducing.
- 3) Assessing the impact of an increased squid harvest upon other living resources of the California Current by investigating what squid consume, what they compete with, and the extent to which other species are dependent upon squid as a food resource.

The Department of Fish and Game is involved in several of the research activities mentioned above.

Two research cruises have been completed, one from La Jolla to Santa Cruz and one from Monterey to the Oregon border. The first cruise revealed the existence of fishable concentrations of squid at three heretofore unknown locations south of Monterey. Few squid were observed on the second cruise, a condition reflecting their general scarcity off northern California during the spring of 1975.

Gross morphometric data obtained by sampling commercial catches during 1974 were analyzed. They indicate the occurrence of localized populations in northern and southern California. These results by themselves, however, are inadequate to verify the existence of actual

subspecies. Biochemical research was conducted on blood proteins and more than 23 squid enzyme systems in an effort to establish the feasibility of electrophoresis as a tool for revealing genetic isolation, should it exist. Blood serum proteins and two enzyme systems, phosphoglucosmutase and the acid phosphotase esterases, have demonstrated polymorphism. As a result, we feel electrophoretic analysis of squid proteins is an acceptable technique. An extensive sampling regime has been devised to produce statistically reliable results, and morphometric analyses have been extended to beak and sucker disc anatomy.

Modal length frequency progressions utilizing samples from Monterey Bay indicate that the market squid achieves maximum size in 1 to 1.5 years. Microscopic observation of hard parts revealed growth increments in the beak, pen, and statolith. The statolith appears to be the most promising organ for age determination. Over 100 have been read to date, and daily and monthly growth rings have been discovered. Preliminary calculations based on these rings indicate that market squid spawn when 1.5 years old.

*Herbert W. Frey*

### **MARINE LIFE RESEARCH GROUP SCRIPPS INSTITUTION OF OCEANOGRAPHY**

July 1, 1973, to June 30, 1974

#### ***Biological Studies***

Edward Brinton in collaboration with Margaret Knight and Tarsicio Antezana has studied euphausiid crustaceans and has extended their research to include life histories and details of larval development of important species occupying the region of the California Current and corresponding coastal waters of western South America. The near shore part of the California Current System appears to sustain a more homogeneous and self-sufficient biota than had been generally supposed, as evidenced by geographical continuity in populations of the temperate species *Euphausia pacifica* and *Nematoscelis difficilis*. Rates of recruitment, growth, and production of euphausiids are associated with 6 to 12 month life cycles which, even to the south of Point Conception, remain strongly geared to the seasonality of environmental processes. There is increasing evidence connecting the degree of success of a cohort to the timing of its initiation in relation to timing of habitat events, e.g., perturbations in temperature, speed, and direction of transport. Further, it has appeared possible to learn something about the extent and direction of population mixing by means of a series of comparisons among size-frequency diagrams of euphausiid populations derived from the different localities in a given CalCOFI grid survey.

With literature now available, it is difficult to identify single larvae of most species of Euphausiacea. As

part of a project to provide identification and eventually a key to larvae of the California Current euphausiids, the larval development of *Euphausia gibboides* Ortmann, a major species of this current system, has been described and illustrated. The larvae of two very closely related species, *E. sanzoi* and *E. fallax* from southeast Asia and the Indian Ocean, are now being studied. The close relationship of the three species, determined on the basis of adult morphology, is substantiated by the study of the larval phases of their life histories. The fine details of larval morphology are now being analyzed with much interest as they appear to demonstrate unsuspected affinities within this group of species.

Krill Expedition lead by Brinton to South America on AGASSIZ during May–September 1974 studied the distribution of plankton in relation to the conspicuous oxygen minimum layer of the eastern tropical Pacific. *Euphausia mucronata*, the abundant krill of the Peru-Chile Current, and a biogeographical homologue of *E. pacifica*, was the object of a population analysis by Antezana, an SIO graduate student from Chile. Numerous South American scientists participated in the cruise.

Study of southeast Asian euphausiids centers on South China Sea and eastern Indian Ocean material, particularly from the Naga Expedition. Five new volumes of Naga Reports are in press this year, these dealing with physical oceanography of the area and plankton biology and taxonomy.

Abraham Fleminger and Kuni Hulsemann continued their investigations on evolution and biogeography of planktonic copepods, concentrated on questions of range, habitat, speciation, and geographical variation on tropical to subtropical epipelagic calanoids belonging to the predaceous Pontellidae and the herbivorous Calanidae.

An analysis of geographical distribution relative to hydrography in the Indian and Pacific Oceans now in manuscript indicates that the habitat of the copepod *Pontellina* is equivalent to surface waters overlying the thermocline. Each species appears to be genetically adapted to migrate vertically only within the prevailing depth of regional surface water masses and it is proposed that the habitat and geographical range are determined by the semiclosed circulation of the surface water mass and the availability of suitable food within the depth range limits of the species.

Patterns of geographical distribution in American coastal zone zooplankton were examined by Fleminger and Hulsemann and a comparative analysis of character divergence relative to geographical overlap was made of the indigenous species of *Labidocera*. The extent of morphological divergence in secondary sexual characters and in feeding appendages was estimated relative to geographical relationship among sets of sympatric and allopatric species. The results show strong positive selection for reproductive isolating mechanisms but little or no evidence of selection pressures affecting the mor-

phology of feeding appendages or body size among co-occurring species.

In tropical plankton the ecologically important family of primary consumers, Calanidae, is represented by the genus *Undinula*. As with its temperate-polar counterpart, *Calanus*, identification of species of *Undinula* has persistently confused plankton workers. During their ongoing survey of integumental organs in the family Calanidae, Fleminger and Hulsemann found evidence that these morphological features could be used to unravel the taxonomy of *Undinula*, the key being the integumental organs of females located at body sites utilized by the male in mating and in spermatophore placement. The results show an interesting biogeographical pattern of two sets of sibling species varying in geographical contact and in extent of polytypy in females as well as adding support to the tropical-subtropical biogeographical patterns in the world's oceans, previously demonstrated by means of other genera.

The scanning electron microscope was used to explore various morphological features difficult to examine by conventional light microscopy and to develop a systematic collection of diagnostic illustrations of American copepods in the California Current. Initial results are very satisfactory and, as time permits, at least all of the common species of the region will be catalogued photographically. In addition to obtaining a remarkably informative permanent photographic record for analysis, the survey revealed a number of features of considerable systematic potential.

Lanna Cheng is studying some of the special adaptations of *Halobates*, the only pelagic marine insect, to its unique environment. These insects have a very efficient mechanical gill—the plastron—which enables them to breathe when accidentally submerged, for instance, during storms. In collaboration with Richard Lee, she also has investigated the lipids of these insects. They are able to store food in the form of triglycerides in much larger quantities than do their freshwater relatives, thereby enabling them to survive without food for 2 weeks.

Daniel M. Brown has developed four new systems for sampling marine organisms. One is a conversion of the Isaacs-Kidd midwater trawl into an opening-closing net. Another is a closing vertical towed net built to reduce the handling and "scaring" problems of this style of sampling. The third is a trap which can capture live fish at great depths, hold them in their own cold water, and keep them under pressure. The fourth is a low cost free-vehicle drop-camera system developed to photograph schools of fish detected on sonar, providing a simplified method of identifying pelagic fish stocks.

#### *North Pacific Central Gyre Studies*

Under the direction of John A. McGowan, several studies are being conducted in the North Pacific Central Gyre. A historical review of the scientific



information about the hydrography, population and community biology, and fisheries of the area (25–35°N, 145–160°W) is nearly completed.

Until 1968 very few studies were devoted specifically to attempts to understand processes and events taking place within the gyre itself, and the gyre was thought of as being a rather homogeneous environment with clear warm water, a deep permanent thermocline, and very low standing crops of phytoplankton, zooplankton, and fish. The only controversial aspect of this area concerned the assertion of Sverdrup, Johnson, and Fleming in 1942 that there was actually a double anticyclonic circulation system in the area.

In the last decade it has become apparent that much of the weather (and to some degree climate) is strongly influenced by air-sea interaction and because the North Pacific Central Gyre is so large and shows such pronounced long term but migrating surface temperature anomalies, the gyre is thought to be very important. The central gyre best approximates a closed biological system, an essential assumption in ecosystem theory. The fisheries potential, although small on a unit area basis, is fairly large because of the large total area. For example, the commercial fisheries catch from the area (25–35°N, 145–160°W) has been tabulated by species for the years 1967–71. These are tuna, swordfish, marlin, and skipjack (nine species total). The value of this catch to the fishermen (in 1973 prices) was \$7,356,062.

The large vertically-stable low-productivity central gyre has boundary zones which are much less vertically stable than the gyre itself. The exact locations of boundary zones, however, are not well documented. There is physical and biological evidence from the upper few hundred meters that the northern boundary, whose axis is centered about 40°N, does fluctuate latitudinally and may reach as far south as 37°N. Thus this zone of increased vertical mixing may be rather close to the locales being studied. There is new evidence for a double gyre system in the central North Pacific. This evidence is biological, physical, and theoretical. If there is a double gyre system, then the meridional boundary zone between the two gyres (main axis about 170°W) could be an area of enhanced vertical mixing.

The initial field program in the North Pacific Central Gyre concluded with six expeditions to the vicinity of 28°N 155°W. These completed the series of samples for seasonal coverage as well as providing opportunity for special projects. Elizabeth Venrick is examining the phytoplankton samples for differences in the composition and seasonal development of the deep shade-adapted layer, which characteristically occurs during the summer at 120 m, and the very distinct low nutrient populations which occur at shallower depths. These observations have been supplemented by concurrent studies on phytoplankton dynamics conducted by the Food Chain Research Group (FCRG) in the Institute of Marine Resources.

Analysis of 9 years of field data on the distribution of the nitrogen fixing bluegreen alga *Richelia intracellularis* in the North Pacific was concluded. There is strong evidence that this may represent a significant source of new nitrogen to the euphotic layer, at least on a local scale, and blooms of *Richelia* are correlated with increases in phytoplankton standing stock and productivity in the upper 60 m.

Present studies led by McGowan in collaboration with members of the FCRG include the distributions of chlorophyll-*a*, primary productivity, and zooplankton standing crop.

Chlorophyll-*a* is a very good measure of the standing crop of plants. Variations in plant standing crop, in time and space, are an integral part of the ecological dynamics of the system and can, in a nutrient limited situation, provide clues as to the input of deeper, nutrient rich water in the recent past. A very large set of chlorophyll-*a* data from the central gyre has been processed and is being analyzed. One outstanding result is the discovery of the deep chlorophyll maximum at 110 to 120 m.

Variations in plant growth where light is adequate for photosynthesis are directly related to the rates of input of inorganic compounds of nitrogen and phosphorus. The outstanding feature of the central gyre is that the rate of input of nutrients to the upper zone (< 150m) appears to be inadequate to support the observed rate of photosynthesis. Apparently vertical mixing in this area is not yet understood.

A phosphate trial-balance sheet which includes uptake by phytoplankton, recycling by zooplankton, and vertical eddy diffusivity does not balance. One implication is that there is more vertical and/or horizontal mixing of nutrient rich water into the area than we can account for with orthodox knowledge. There are strong reasons to believe that it is vertical mixing rather than horizontal mixing. Perhaps vertically migrating creatures also transport significant nutrients.

The primary productivity (photosynthetic rate) is an instantaneous measurement of rate which depends on nutrient input, light, and the "history" of the plant population. A most interesting result is that the summer of 1969 had twice the productivity rate of previous or subsequent summers. Apparently some significant mixing event was taking place or had taken place the previous spring or winter.

The zooplankton standing crop is a mixture of herbivores and first-stage carnivores. Their abundance is strongly dependent on the immediate and previous productivity regime. But because of their rather slow turnover rate (weeks to months), they tend to integrate, over time, the productivity dynamics. The major reason for this, other than their length of life, is that they tend, by their excretory processes, to recycle nitrogen and phosphorus compounds thus increasing the residence time of these nutrients. In accord with the productivity data, the standing crop of zooplankton in the summer of 1969 was twice that

of previous or subsequent summers, indicating a greater than usual upward mixing of deeper nutrient rich water sometime in the previous few months.

Data have been obtained on two size-categories of actively swimming organisms (= nekton), the 1-15 cm fish and the much larger commercial fish of the area. The smaller fish are mostly mesopelagic, living at depths of over 300 m during the day and migrating to or near the surface at night. These migrators are the major predators on zooplankton and are thus an important part of the system. They, along with the diurnally vertically migrating zooplankton, could serve as an active vertical transport vehicle for nutrients and other substances such as radioactive compounds.

A very large number of hydrographic measurements exists in the central gyre data set. These have been only partly processed. Most of them cover depth ranges of 0-700 m but a substantial number go to 2000 m and a few to the bottom. Temperature curves from 1969 indicate an unusual hydrographic event.

#### *Deep Circulation*

Studies of the circulation of the Pacific Ocean and the South Atlantic Ocean have been carried out by Joseph L. Reid. Published results of the Boreas expedition, carried out in January-April 1966 in the Northwest Pacific, the Bering Sea, and the Okhotsk Sea, have shown that convective overturn extends to no more than 150 m depth even in midwinter, and in much of the area to less than 100 m. The characteristic low temperature and salinity at the surface are transmitted to greater depths (and then laterally throughout the North Pacific as Intermediate Water) by mixing through the pycnocline rather than by convective overturn.

At somewhat lower latitudes, a shallower salinity minimum is found in both the North and South Pacific above the Intermediate Water salinity minimum. These shallower salinity minima originate in the equatorward eastern boundary currents along both North and South America and extend westward with the extension of these currents north and south of the equator, and can be detected as far as the Philippine Islands north of the equator.

Measurements of flow and water characteristics in the abyssal Pacific made near Samoa have shown not only an abyssal northward flow of water near 5000 m in the deep and narrow Samoa Passage, but a southward return flow of water near 3000 m. This suggests that some of the deeper waters of the North Pacific may leave the Pacific by passing southward along the Tonga-Kermadec Ridge into the Antarctic Circumpolar Current.

William Patzert is working with Reid to describe the circulation of the various water masses found in the southwestern Atlantic Ocean. Among the new findings as a result of the Cato Expedition of 1972 are the relationships between the deep high-stability lay-

ers found in the water column and large scale circulation.

The results of Patzert's earlier studies on the seasonal variability in the circulation of the Red Sea and its relation to the monsoon oscillations over the Indian Ocean have been reported, and two studies of the flow around midocean islands have been published.

During April-May 1974 Patzert was Associate Chief Scientist aboard the MELVILLE for GEO-SECS-Leg J expedition and is currently analyzing two long sections of closely spaced XBTs from the expedition for evidence of baroclinic instability as a mechanism for mesoscale eddy formation.

A preliminary study of sea surface temperatures from coastal and island stations was just initiated. Initially, the amplitudes and phases of anomalies will be viewed to understand the coherence along the eastern oceanic boundary and out to the island stations. The results from these continuous records should indicate a plan to analyze the offshore data from the CalCOFI cruises. The ultimate objective of this work will be to describe and understand the longer term fluctuations at the eastern boundaries, in general, and along the California coast, in particular.

#### *Anaerobic Sediment Investigations*

The study of marine sediments is a means of extending the historical perspective of oceanic events. Not only does sediment provide access to material characteristic of past times but, due to effective horizontal dispersion of sediment particulates, the material is also characteristic of broad areas.

Marine anaerobic sediments are particularly valuable in that they can be resolved on time intervals approaching 1 year. Using techniques including box coring methods that consistently obtain the present sediment surface, verification of sediment surface recovery by the presence of excess Th-228, and stratigraphic dating by varve and Pb-210 chronology, John D. Isaacs, Andrew Soutar, Stanley A. Kling, and Peter A. Crill have been able to perform detailed historical studies.

In the Santa Barbara, Santa Monica, and San Pedro Basins these studies include such elements as common lead and its isotopic ratios, mercury, and a suite of metals. Many substances show a systematic increase in concentration over the past few decades and record the magnitude of the effect of man on the geochemical balance in the coastal sea off California.

A detailed investigation of fish debris in the sediments of the Santa Barbara and the Soledad Basins has provided insight into the historical abundance of pelagic fish of the California coast. Correlation between fish populations, as determined by fishery statistics and fish scale deposition in sediments, has shown that the interpretation of past abundance levels is probably reliable. The historical perspective suggests the past 30 years have been characterized by considerably high levels of anchovies, and that the

sardine passed through a protracted period of low abundance in the last part of the 19th century, as it had during a number of other occasions during the last 15 centuries.

Soutar and Kling are presently developing their investigations to include climatological and ecological factors in the sea of California and in other areas such as the Gulf of California and coastal Peru.

*Joseph L. Reid*

**NATIONAL MARINE FISHERIES SERVICE  
SOUTHWEST FISHERIES CENTER  
LA JOLLA LABORATORY**

July 1, 1973, to June 30, 1975.

The federal commitment to CalCOFI coordinated research has continued through several major reorganizations as a central element in the research program of the NMFS Southwest Fisheries Center's La Jolla Laboratory for the past 28 years.

CalCOFI related activities are carried out in the Coastal Fisheries Resources Division, headed by Reuben Lasker. The Division was organized at the La Jolla Laboratory to perform the research and analyses required for management of the coastal recreational and commercial fisheries of the California Current. Some of the fish resources of concern to this division are the anchovy, the Pacific and jack mackerels, Pacific sardine, barracuda, and white seabass. Among the studies conducted by this division are laboratory and field work to help determine the basic causes of larval fish mortality. This information, being developed for the northern anchovy, as well as earlier work on the physiology of fishes, is being incorporated into computer models for increasing the understanding of the process of recruitment to fisheries. In turn, the results of recruitment studies are being incorporated into the stock assessments of the coastal recreational-commercial fishery resources that are being undertaken in cooperation with the State of California.

In addition to stock assessment, the requirements for research and management information with respect to these fisheries are being explored with the State of California and with Mexico. The stock assessment efforts are based on a broad range of techniques open to fishery scientists and include ship surveys involving collection of fish eggs and larvae, acoustic assessment techniques, catch and effort analysis, and the analysis of existing fishery and biological data. Considerable efforts have been devoted to developing the 25 year CalCOFI data base to achieve computer analysis capability.

Because of space limitations, the report which follows is not a complete account of CalCOFI research activities conducted at the La Jolla Laboratory but does present highlights of significant research progress and accomplishments.

***Life Studies: Larval Fish***

At the La Jolla Laboratory, the conduct of larval fish studies is directed toward specific problems of the varying factors which affect the survival/mortality of the larvae of coastal pelagic and recreational fishes.

Studies continued on the refinement of techniques and methods for inducing the spawning of selected commercial and recreational fishes to obtain laboratory materials, with particular attention to the Pacific mackerel and northern anchovy. A successful method has been developed by Roger Leong to mature Pacific mackerel in the laboratory throughout the year under different light-temperature conditions and to spawn them on demand with gonadotropic agents. In nature, the Pacific mackerel spawns off the southern California coast only during May through August. It has been found that temperature is far more important than the photoperiod in regulating maturation and a high temperature, 19° C or more, accelerates ova development. However, prolonged exposure to high temperatures also has a debilitating effect and the state of health of the fish begins to decline in about 4 months with eventual death in about 6 months. The fish develop more slowly at 16° to 17° C, but the mackerel remain healthier and a few are ripe the year around. The ripe fish can be detected through a biopsy technique and can then be spawned with a combination of hormone injections. The combination now being used is 1 mg of crude salmon pituitary followed 24 hours later with 100 units of gonadotrophin from pregnant mare serum.

***Plankton Microstratifications in Coastal Waters off California***

Considerable effort has been devoted to an investigation of plankton microstratification in the coastal waters off California. This information is essential for an understanding of the survival of anchovy larvae and other larval fish. Food studies in the sea and in the laboratory indicate that the average food density in this area will not support life of larval fishes. Consequently, the survival of larval fishes depend on the patchiness of the food distribution, that is, on plankton microstratification.

Several meetings were organized by Robert Owen to plan a multipleship effort scheduled for March 1976, to measure small scale plankton distributions and mechanisms of phytoplankton and zooplankton patchiness, co-patchiness of species, and association of fish larvae with higher density zones of food sized particles.

***Starvation as Cause of Mortality in Jack Mackerel Larva***

A project began in April 1975 to evaluate starvation as a cause of mortality in mackerel larvae. Jack mackerel are of major importance in the California wet-fish fishery. The major objective of the study is to

establish histological criteria for estimating the extent of starvation in sea-caught jack mackerel larvae. Once these criteria are established, sea-caught larvae will be examined to determine the incidence of starvation. The work should greatly improve the understanding of causes of larval mortality and, therefore, relationships between stock size and recruitment. As a first step, starvation criteria are to be established through laboratory experimentation. Subsequently, jack mackerel eggs will be collected at sea and the larvae reared in the laboratory under controlled conditions. Histological techniques will be employed to determine normal cellular growth in larvae at various stages of development to compare with that of larvae that have been starved.

#### *Histological Study on Effects of Starvation on Anchovy Larvae*

The study of developmental anatomy of larval marine teleosts was begun by Charles O'Connell at the La Jolla Laboratory to describe the differentiation of sensory and other organ systems in respect to variations in the laboratory-rearing environment.

Detailed descriptions of organ system development are used in conjunction with laboratory behavior studies to evaluate the changing capabilities and requirements of the marine fish larvae as they grow. Variability in organ system development has been examined for possible symptoms of early mortality.

Work was also undertaken to ascertain the effects of starvation on the histological condition of early post yolk sac anchovy larvae. The ultimate purpose is to identify particular histological features, or combinations of features which are indicators of the starving and/or dying condition. Results of histological examination of anchovy larvae reared to the age of 10 days in the laboratory with and without food have been assembled. About 2 days after final yolk absorption, the histological changes that signify severe emaciation are evident. The changes in muscle, notochord, cartilage, pancreas, and midgut are progressive and constitute indicators for judging whether larvae are slightly, moderately, or severely emaciated. It was noted by O'Connell that while 6 and 7 day old larvae tend to be robust if food has been available and severely emaciated if it has not, 3 and 4 day old larvae show the reverse. Those larvae without food appear to be robust, while those reared in the presence of food and who have been feeding, show signs of slight to moderate emaciation.

#### *Transfer of Chlorinated Hydrocarbons through a Marine Food Chain*

Sponsored by the International Decade of Ocean Exploration—National Science Foundation, a study was completed by Ed Scura and Gail Theilacker on the transfer of chlorinated hydrocarbons (CHC) through a marine food chain. This work was unique because for the first time a study of this kind was made at the low concentrations of CHC pollutants

usually found in the sea, i.e., in parts per trillion, and with a food chain using northern anchovy larvae. The results were surprising since in experiments using the C<sup>14</sup> labeled CHC, it was found that larvae who were not feeding took up approximately the same amount of C<sup>14</sup> CHC as those fed algae containing relatively high levels of CHC. Furthermore, CHC uptake seems to be intimately related to the amount of lipid in the tissue of the algae cells or animals. Anchovy larvae, therefore, must take up CHC directly from sea water.

Two major technical advances were made during the course of the study. A method was discovered for introducing CHC into sea water to attain the parts per trillion levels desired by simply bubbling laboratory air into sea water and a method was devised for analyzing parts per trillion of CHC in 1 liter samples of sea water.

#### *Field Criteria for Survival of Anchovy Larvae*

Laboratory work of long duration at the La Jolla Laboratory has led to the hypotheses that survival of fish larvae depends on particle size, density, species composition, and distribution (vertically and horizontally) of their food. Preliminary tests of this hypothesis bore out the further assertion that laboratory derived information could be used to set the criteria for threshold density levels and the kind of food needed by fish larvae to survive.

In a striking new approach to one of the major problems in fishery biology—that of predicting recruitment failure—a study was begun by Reuben Lasker to show how laboratory spawned fish larvae can be used to detect larval feeding grounds at sea and to point out some of the ways this technique might be used to provide the link between marine food chain research and stock and recruitment predictions in fisheries; the latter by determining what the environmental conditions at sea must be with respect to larval fish food to result in a good or bad survival year for particular species of fish larvae.

Northern anchovy larvae, provided by laboratory spawned fish, were used to detect concentrations of larval fish food *in situ* along the California coast. First feeding larval anchovies, whose development was controlled by temperature manipulation aboard ship, were placed in samples of Los Angeles Bight water taken from the surface and from chlorophyll maximum layers. The following information was thus accumulated in the California Current:

Food particles of the right size for larval anchovy feeding (i.e., ca 40 microns diameter) occur above threshold levels needed for feeding (i.e., more than 30 particles/ml) chiefly within the first 5 miles of the shore. In California waters dinoflagellates, e.g. *Gymnodinium splendens* and *Gonyaulax polyedra*, have been the dominant food organisms. Threshold concentrations and higher of larval food are most often found in chlorophyll maximum lay-

ers about 15 m deep, but frequently there are above threshold concentrations near the surface. Vigorous storms and upwellings have been observed to break up the chlorophyll maximum layers and to reduce the number of food particles below the threshold number needed for first feeding anchovy larvae to survive. Anchovy and a variety of other fish larvae are found within and above these inshore layers.

Cruises held from September 1974 through April 1975 showed that a chlorophyll maximum characterized by a dominant species of dinoflagellate, *G. polyedra*, extended from Point Conception to San Diego, California, and persisted through January. In January, numbers of the 30 to 50 micron diameter particles increased generally over the entire survey area and spread seaward beyond the usual 5 mile extent of the 15 meter chlorophyll maximum.

In February, a major upwelling on the west coast of California dispersed the chlorophyll maximum and by early March the characteristic concentration of 30 to 50 micron particles in the Los Angeles Bight had dropped well below the larval fish feeding threshold, i.e., to 1 to 5 particles per ml over the entire Los Angeles Bight.

In early 1975, particle counts in the same region (approximately 3 weeks after the previous cruise) show particle counts have increased above threshold within 2 miles of shore from at least Santa Monica to Del Mar, California, or about 150 km. Sampling was restricted to this area because of ship time restrictions.

#### *Marine Environmental Assessment*

Basic to the objectives of CalCOFI is the assessment of stock levels and the estimation and prediction of recruitment of fish into the fishery. Historically, these have involved egg and larva surveys which are one of the basic tools in fishery science for evaluating the kinds and amounts of fish resources. Since the inception of CalCOFI, a group of researchers at the La Jolla Laboratory has been devoted to increasing the efficiency of such surveys by increasing the number of larval marine fish that can be positively identified and by training persons in their identification and description.

Investigators in this project headed by Elbert Ahlstrom have developed the so-called "dynamic approach" in describing the early life history stages of marine fishes. Series of specimens of a species are selected by size from newly hatched larvae to juveniles, and these are studied for developmental changes in body form, in pigment patterns, fin development, ossification, etc. Although for the majority of developmental series being studied, specimens are selected from the extensive CalCOFI collections of fish eggs and larvae, for some many-species groups, such as rockfishes, it is necessary to use a different approach—rearing of eggs and larvae obtained from identified parents to obtain developmental series.

Among the contributions of this group are the preparation of identification handbooks of marine fish eggs and larvae. An identification guide to the larvae and pelagic juveniles of rockfishes and scorpionfishes was completed and in its final form treats seven genera and 20 species of the family Scorpaenidae. Three of these genera and 11 of the species have not previously been described or illustrated. The paper includes species of rockfish from all oceans in which they occur and provides a basis for comparison of the early life histories of these commercially important fishes. Also in progress is a handbook of early life history stages of pelagic marine fishes of the California Current. Information on the pelagic stromateoid fishes has been separately prepared for publication. Ten kinds of stromateoid fishes occur in the CalCOFI area. One member of this group is a choice food fish for human consumption, the Pacific butterfish, *Peprilus simillimus*.

#### *Neuston Net—Supplement to Standard CalCOFI Net Hauls*

Almost all of the fish eggs and larvae taken on CalCOFI cruises have been collected with the standard net hauled obliquely from 200 m to the surface. In May, 1972, 115 neuston net hauls were taken on regular CalCOFI stations from off Puget Sound to below Cape San Lucas, Baja California. In contrast to the standard net, the neuston net is towed at the surface, with only about half of the net immersed. These samples have now been analyzed and it has been found that larvae occurring in largest numbers in the neuston collections were those of the northern anchovy, *Engraulis mordax*, and of the Pacific saury, *Cololabis saira*. Interestingly, a much higher percentage of large anchovy larvae were taken by the neuston net than are proportionately taken in standard net tows—a difference of about 15 times. Most of the large collections of anchovy larvae were obtained in night hauls. Another species that occurred in exceptionally large numbers at one station off the Columbia River was the sablefish, *Anoplopoma fimbria*. A rockfish larva-juvenile which is possibly that of *Sebastes alutus* occurred in large numbers in two collections. This appears to be another species that concentrates at the surface during its rarely found larval stage.

The neuston hauls contained larva-juveniles of 28 families. Over the same CalCOFI grid one would expect to take larvae of at least double this number of fish families. Thus, only a portion of the species are represented in neuston hauls. However, for certain species, such as the Pacific saury, it appears that the neuston net is an indispensable tool for establishing distribution. The number of saury larvae taken on this one cruise was equivalent to the number taken in 2 decades of CalCOFI collections made with oblique plankton hauls.

A subsequent comparison made of fish samples in the neuston nets versus regular oblique plankton

hauls revealed that the family of fishes best represented in both types of hauls was the myctophid lanternfishes. Several kinds of fish from this group were predominant in neuston hauls, while other lanternfishes, common in oblique hauls, were absent from neuston collections.

#### *CalCOFI Atlas—Flatfish Larvae*

Another in the series of CalCOFI atlases dealing with the distribution of fish larvae on CalCOFI cruises was prepared for flatfish larvae. Two genera and six species were included in the atlas. The 6 year period, 1955–1960, the period for which individual status records for these species are most readily available, is covered in the atlas. The atlas presents monthly distributions for the several flatfish that are taken most commonly in CalCOFI collections, and for less common forms, distribution was compiled by quarters. Following previously established procedures, illustrations for each species and a brief description of its distinctive larval features are presented.

Twelve kinds of fish larvae (10 species, two genera) contribute about 90% of the larvae taken on CalCOFI cruises. With the completion of the flatfish atlas, distribution charts of 11 of these 12 kinds of larvae will have been covered in CalCOFI atlases.

#### *Fourth Fish Egg and Larval Identification Course*

With the objective of training NMFS personnel and others in identification of fish eggs and larvae, an intensive course on this subject was given in the spring of 1975. Participants included 21 persons, 13 from foreign countries. During the course, a total of 204 life history series was studied, belonging to 92 fish families. About 10% of the series were based on Atlantic material, 90% on Pacific. This was the fourth time that this course was presented at the Center.

#### *Analysis of Potential Invertebrate Predators of Anchovy Larvae*

Work also continued on an analysis of the potential invertebrate predators of anchovy larvae in the CalCOFI plankton collections by Angeles Alvarino. The numerical abundance of Chaetognatha, Siphonophorae, Medusae, Chondrophorae, and Ctenophora is being determined as well as information on a number of other zooplankters. This detailed study is basic in evaluating the potential predatory impact of the various species and determining corresponding variations in relation to the different stages of the life cycles of species in these zoological groups.

To provide population dynamicists and environmental scientists with information which can be used to monitor the environment more efficiently and to predict the variation in stock size and recruitment in marine fish populations, the approach at the La Jolla Laboratory is to rear coastal pelagic and recreational fishes from eggs through metamorphosis on artificial diets, determining the essential nutritional factors

needed for larval survival. A description of the temporal events in larval fish development is in progress with emphasis on systems essential for capture of food and avoidance of predators.

Among the major advances made in these areas during the past 2 years was the successful rearing of the northern anchovy through metamorphosis on laboratory cultured foods. This was the culmination of a series of rearing studies at the La Jolla Laboratory designed to develop culture procedures for rearing anchovy larvae; in the past, anchovy could not be reared past about 20 days on cultured foods.

In 1970 Kramer and Zweifel recorded the growth of anchovy larvae at 17 and 22° C for periods up to 35 days, at which time the larvae reached an average length of 17 mm. In their experiments, larvae did not reach metamorphosis which occurs at about 35 mm. The larvae were fed wild plankton supplemented by brine shrimp nauplii, *Artemia salina*. In the ensuing years culture techniques using laboratory cultured foods for larval anchovy gradually developed: the dinoflagellate, *Gymnodinium splendens*, for the first 5 days (Lasker, et al.); the rotifer, *Brachionus plicatilis* (Theilacker and McMaster), to about 20 days during which time the fish grew to about 10 mm. During the last year, John Hunter and Carol Sanchez were successful in culturing the copepod, *Tisbe furcata*, which supplied the missing link, that is, provided a food other than *Artemia* for larvae older than 20 days (greater than 10 mm). In all previous attempts, larvae gradually died when fed *Artemia* (the so-called "Artemia syndrome") and what remained to be done was to find a cultured food that could be used for larvae larger than 10 mm. Foods used to rear anchovy larvae to metamorphosis included *Gymnodinium*, *Brachionus*, *Tisbe*, and *Artemia*. Metamorphosis occurred 72 days after hatching at a rearing temperature of 16° C.

The Pacific mackerel, *Scomber japonicus*, was also successfully reared from the egg through metamorphosis by Hunter and Sanchez. This is the first time mackerel have been reared through metamorphosis on a laboratory cultured food, under controlled conditions. At the age of 18 days the larvae had become juveniles and had an average length of 17.8 mm. Eggs were obtained from a laboratory population of mackerel brought to breeding conditions by Roderick Leong.

In a related study, Hunter also conducted a starvation experiment designed to determine how long newly metamorphosed anchovy larvae can survive without food. The experiment demonstrated that newly metamorphosed anchovy can withstand a starvation period of 12–15 days whereas those that had not completed metamorphosis cannot. Lipid content of the fish during starvation declined 30% of dry weight to 12% of dry weight but recovery for surviving fish was rapid as they returned to the 30% level after 5–8 days of feeding. The fat content of newly metamorphosed anchovy was comparable to that of



adult anchovy during the summer and fall when gonadal fat is low. Hunter concluded from this study that the extreme vulnerability to starvation characteristic of the larval phase is over by the time the fish pass metamorphosis.

#### ***Possible Energy-Sparing Mechanism Discovered for Larval Anchovy***

Mechanisms that reduce activity and thereby conserve energy are probably important in the survival of larval fish. Two such mechanisms have been studied on the northern anchovy: 1) kinetic behavior which results in reduced swimming speed in areas of high food concentration, and 2) the effect of temperature on activity. The reduction in activity associated with lower temperatures, however, may be offset by slower growth rates which may increase the exposure to predation. Another possible energy sparing mechanism was discovered by Hunter and Sanchez when they examined in the laboratory the extent of inflation of the gas bladder as a function of time of day and larval length.

They found that northern anchovies 12 mm long inflate the gas bladder at night and deflate it in the day. At night larvae were found to have greatly distended gas bladders which often were so large that they partially constricted the gut, whereas by 2–4 hours after the onset of light the bladders were deflated. At night an obvious gas bubble was present in the bladder; during the day it was absent. At night larvae appeared to be suspended motionless in the water, whereas during the day they were continually swimming and feeding. The most tenable explanation for this diel change in the inflation of the gas bladder is that it permits the larva to adjust its buoyancy to neutrality at night and consequently to conserve energy. The work of a Japanese scientist on another species of anchovy demonstrated that anchovy show the same behavior in the sea.

Also in progress are studies on the effect of prey size on the feeding behavior of larval anchovy and Pacific mackerel. These studies are designed to determine the relationship between size of mouth of the larva and the maximum prey it can ingest and the prey size it can ingest in quantity. Laboratory and field work indicate that the size of food required by a larva increases as the larva grows, and if food is less than the optimal size, growth slows and mortality occurs. Preliminary data indicate that anchovy and mackerel larvae require a prey having a width of about  $\frac{1}{4}$  to  $\frac{1}{3}$  the mouth opening at the time of first feeding and one about  $\frac{1}{2}$  to  $\frac{2}{3}$  the mouth opening thereafter. These data also suggest that larvae after the first few days of feeding are able to capture prey that are nearly as wide as their mouth but do not take them in quantity unless the prey width is  $\frac{2}{3}$  the mouth opening or smaller.

#### ***CalCOFI System Review and Analysis***

Data collections by CalCOFI have been made for

many years in the California Current Region (15–40 years, depending upon particular time series). These include catch and age data on specific wetfishes; sea survey data on juveniles and adults; spawning surveys; physical and chemical oceanographic data; plankton surveys, temperature, and tidal data; and upwelling and transport data. At year's end computer runs of 25,000 CalCOFI time series (1951–1969) of sized larvae of northern anchovy and Pacific sardine were completed. A second series of tables is being created which is corrected by current estimates of the known biases in the collection technique. Specimens of recent data are also available for jack mackerel, Pacific mackerel, and Pacific hake. These data are used for determining mortality rates and spawning biomass of these pelagic fishes.

#### ***Manual of Methods for Pelagic Fish Egg and Larva Surveys***

A 350 page manual of methods titled, "Standard Techniques for Pelagic Fish Egg and Larva Surveys", edited by Paul Smith has been completed under contract with the FAO of the United Nations in Rome. The text of the manual, based on materials presented during a training course on larval fish at the La Jolla Laboratory, includes two sections—one on the practical aspects of conducting an egg and larva survey and one on the theoretical basis for interpreting the survey data. The recommendations include use of a simple bongo net in a slow, oblique tow for optimum economy of operation and capture and retention of fish larvae. A bibliography of surveys and larva and larval identification has been assembled, as part of the manual. The bibliography has been indexed to taxonomic groups and geographic regions.

#### ***Automated Hydroacoustic Data Acquisition and Processing System***

A technical need exists for the development of an operational hydroacoustic tool for assessing pelagic fish stocks. The collection of large amounts of sonar target data, necessary for the isolation of sampling errors and biases associated with acoustic assessment methods, has meant subjective logging by hand, accounting and processing procedures aboard the NOAA research vessel, JORDAN, and at the laboratory in La Jolla, following a sonar cruise. During the present reporting period, an automated sonar data acquisition and processing system was developed at the La Jolla Laboratory by John Brown and Rodger Hewitt, with the cooperation of the Naval Undersea Center in San Diego.

The ship's speed and time are recorded with each target and used to calculate the area surveyed. It is used in the data collection program to determine when an oceanographic station has been reached and to suspend data recording while on station. Start pulses continue to be counted, however, and the time at the beginning and end of the station is recorded.

In shipboard operation, the system requires no attendance. Prior to departure, the computer is started, and the hour counter preset to the current time. The sonar system is then started and may be left in operation 24 hours a day or turned off at night. At the end of the day (1600 hours), the data collection program is replaced by a general computational program. This program change is accomplished automatically from a prerecorded magnetic tape cartridge. The stored target data are reduced, summarized, and dumped into peripheral mass storage capable of holding the entire trip's collection.

The system was successfully used at sea during the first two in a series of six survey cruises conducted in 1975 (the CalCOFI station grid is occupied every 3 years on a monthly or bimonthly interval). Acoustic dimensions on 5,000 targets were tabulated over an area ranging from Point Conception, California, to Magdalena Bay, Baja California, and seaward typically 150 miles. While 50% of the schools detected are less than 50 m, it is believed that the northern anchovy is the predominant species sampled by the horizontally directed sound waves.

Photo analysis, using a method developed by John Graves, is also expected to yield independent information relating sonar measurements to school compaction. The development of a free-vehicle drop camera by D. Brown of the Scripps Institution of Oceanography has provided a new tool for fish school species identification.

Various system improvements are being planned which include an automatic variable threshold based on integrated volume reverberation, peripheral data storage, and a towed body transducer array. From the progress made thus far, however, it now appears that the goal of obtaining real time, biomass estimates of pelagic fish schools in the California Current region is feasible.

#### ***Cooperative CF&G-NMFS Research on Status of Fish Stocks***

Strong State of California/Federal cooperation presently exists in the research, analysis and management of fisheries of common interest. Although past state/federal cooperative research in CalCOFI has developed a large amount of data on marine fish eggs

and larvae, little is known about the factors that control survival from egg to recruitment. As an initial approach to this overall problem, a study and analysis of the current status of such California coastal recreational and commercial fish stocks as yellowtail, anchovy, bonito, and mackerel was undertaken in 1974 in cooperation with the California Department of Fish and Game. The principal researchers, Alec MacCall of CF&G and Gary Stauffer of NMFS concluded from their preliminary stock assessment work that the northern anchovy and jack mackerel are lightly exploited and should be able to sustain larger catches; the Pacific sardine and Pacific mackerel stocks are extremely depleted and show little indication of recovery; California barracuda is depleted and is now subject to a length restriction conducive to rehabilitation; conflicting evidence indicates that the white seabass resource is fully to over exploited; the California yellowtail is lightly exploited. This information is being used as a guide for future work and to determine if any of the stocks are in need of immediate management action.

#### ***Cooperative Fisheries Research with Mexico***

The NMFS was represented by Reuben Lasker, Chief of the Coastal Fisheries Division at the La Jolla Laboratory, at the meeting of CalCOFI scientists who met in Mexico in June 1975 to discuss areas of mutual interest and possible collaboration in the study of anchovies in the California Current area. As a starting point, the establishment of four working groups was approved:

- a) status of the anchovy stocks
- b) acoustic surveys
- c) egg and larva surveys
- d) catch per unit effort

Other types of collaborations discussed at this meeting included FAO Fellowships at the NMFS Southwest Fisheries Center and scientific consultation by La Jolla Laboratory scientists in Mexico.

Lending urgency to these informal cooperative research efforts was the announced intention at year's end of the Mexican government to take 500,000 tons annually of northern anchovy for processing into fish meal.

*Brian J. Rothschild*



## REVIEW OF THE PELAGIC WET-FISHERIES FOR 1973

Commercial landings of pelagic wet-fish species increased both in 1972 and 1973, due mostly to the growth of the anchovy reduction fishery (Table 1). Anchovy landings in 1972 were the second highest total since the inception of the fishery, and preliminary figures for 1973 indicate that a new record may be set. Although jack mackerel and squid landings were down slightly both years, they were about equal to the average tonnage for the previous 10 years. In accordance with the 1969 legislation which limits the sardine catch to 250 tons for bait use, only 186 tons were landed in 1972, and even fewer in 1973. The Pacific mackerel catch, also limited by law, has declined to its lowest level since the Department of Fish and Game began keeping records.

TABLE 1  
Landings of Pelagic Wet-Fishes in  
California in Tons; 1964-1973

Year	Sardine	Anchovy	Pacific Mackerel	Jack Mackerel	Herring	Squid	Total
1964	6,569	2,488	13,414	44,846	175	8,217	75,709
1965	962	2,866	3,525	33,333	258	9,310	50,254
1966	439	31,140	2,315	20,431	121	9,512	63,958
1967	74	34,805	583	19,090	136	9,801	64,489
1968	62	15,538	1,567	27,834	179	12,466	57,646
1969	53	67,639	1,179	25,961	85	10,390	105,307
1970	221	96,243	311	23,873	158	12,295	133,101
1971	149	44,853	78	29,941	120	15,756	90,897
1972	186	69,101	54	25,559	63	10,081	105,044
1973	76	131,919	28	10,308	1,410	5,959	149,700

During 1972 there were 37 purse seiners and 10 lampara boats (not including those solely involved with live-bait fishing) which landed wet-fish species at California ports, although some were only occasional contributors. One purse seiner sank in November's rough weather with a full load of anchovies on board. All but one of the purse seiners were based in San Pedro or Port Hueneme; the remaining purse seiner and the majority of the lampara boats were based in Monterey.

The wet-fish fleet of 1973 was larger than that of the previous year, both in number of boats and in carrying capacity: 42 purse seiners and 11 lampara boats were involved in the fishery. Three of the new additions to the fleet have relatively large (200 ton) carrying capacities: two are converted tuna bait boats and one is a former Peruvian anchovy purse seiner built in the U.S.A. The overall increase in number and size of boats reflects the optimism with which the future anchovy fishery is regarded.

### Northern Anchovy

For the 1972-73 reduction season the California Fish and Game Commission authorized a 110,000 ton quota: 10,000 tons for the northern permit area (from Pt. Conception north to the Oregon border) where

the season opened on August 15; and 100,000 tons for the southern permit area (from Pt. Conception south to the Mexican border) where the season opened on September 15. When the season closed in both areas on May 15, 1973, almost 75% of the total quota had been filled: 75,520 tons had been landed (Table 2).

TABLE 2  
Anchovy Landings for Reduction in the Southern and Northern  
Permit Areas in Tons From 1968-69 Through 1972-73

Season	Southern Permit Area	Northern Permit Area	Total
1968-69	25,314	2,736	28,050
1969-70	81,684	1,803	83,487
1970-71	81,420	608	82,028
1971-72	52,440	986	53,426
1972-73	73,176	2,352	75,528

As the season opened, fishermen were receiving \$21.00 per ton of unprocessed fish. The price rose steadily all season and closed at \$47.50, reflecting an increase in world fish meal prices. This increase was attributed to the drastic reduction of the Peruvian anchovy catch which, prior to 1972, had been the world's largest source of anchovy meal. Peru's anchovy population has dwindled considerably recently due to rapidly increasing fishing pressure coupled with the appearance of El Niño conditions.

A warm water influx also affected California in 1972 by bringing in great numbers of Pacific bonito and bluefin tuna. Hence the anchovy season got off to a slow start since fishermen concentrated their efforts on the more profitable large fish. But beginning in late December and continuing to the end of March, the weather was sufficiently rough to cause all fishing efforts to come to a standstill. An abrupt reversal took place in April: good weather prevailed, and the anchovies formed large, dense, readily available schools close offshore. During the last 6 weeks of the season, more than half the entire season's catch was landed at southern California ports. The canneries found it necessary to impose daily limits on the tonnage landed by each boat, in order to prevent accumulation of too many fish for the plants to process.

The 1973-74 season got off to a rousing start as anchovies remained plentiful and easily obtained. The 10,000 ton quota for the northern permit area was filled within 3 months, so on October 5, 1973, the Fish and Game Commission added an extra 5,000 tons to the quota, and moved the boundary between the northern and southern permit areas approximately 50 miles northward to Pt. Buchon.

At the beginning of the season, the price for anchovies was at an all-time high of \$57.50 per ton. It declined gradually towards the end of the season to \$41.00.

TABLE 3  
Commercial Landings and Live Bait Catch  
of Anchovies in Tons; 1966-1973

Year	Reduction	Other Commercial	Live Bait	Total
1966.....	27,348	3,705	6,691	37,731
1967.....	32,349	2,455	5,387	40,191
1968.....	13,795	1,743	7,176	22,714
1969.....	65,204	2,435	5,538	73,177
1970.....	92,955	3,288	6,105	102,348
1971.....	43,652	1,200	6,387	51,239
1972.....	66,617	5,868	5,850	74,949
1973.....	130,547	1,372	6,216	138,135

#### *Live Bait*

The live-bait fishery had a very successful year in 1972 (Table 3), with anchovies readily available to meet an increase demand for bait from sportsmen due to the unusual abundance of yellowtail. However, the 1973 season was less favorable. Although anchovies were present in sizeable numbers, their behavior was erratic, making them difficult to catch. There was a large proportion of "pinheads" (small fish-of-the-year) which are unsuitable for hook bait. Bait haulers agree that there were more young fish this year than in any previous season, an indication of a healthy anchovy population to be utilized in the near future.

#### *Pacific Sardine*

Protective legislation for California's sardine population remains in effect, prohibiting the take of sardines except under two circumstances: (1) as incidental catches (less than 15% by weight), or (2) as dead bait, since the law allows 250 tons to be landed each year for this purpose. Only 186 tons were caught in 1972, and less than 76 were landed in 1973. Most of these fish were found close to shore between Port Hueneme and La Jolla.

A new law will go into effect on January 1, 1974, which completely prohibits the taking of sardines for any purpose, except as incidental catches which may be used for canning or reduction only. Besides providing a moratorium on the commercial fishery, the law also sets forth a management plan for the recovery of the sardine population. When the spawning population of the northern stock reaches 20,000 tons (as determined by the California Department of Fish and Game), 1,000 tons may be taken, with increases as the spawning stock increases.

#### *Jack Mackerel*

Jack mackerel landings were down in 1972 mainly as a result of a shift in effort from mackerel to Pacific bonito and bluefin tuna. The fleet landed the major part of the year's mackerel catch between July and

September when mackerel were plentiful around Cortez Bank. For the rest of the year jack mackerel landings were poor due to (1) scarcity of fish, (2) bad weather conditions, and (3) the abundance of bluefin and Pacific bonito which are more profitable catches for the fishermen. The year 1973 was an extremely poor jack mackerel year. Landings were scattered throughout the year, with only a few weeks of solid mackerel fishing.

The price paid to the fishermen by the canneries held steady at \$80-85 per ton throughout 1972, and for most of 1973 it remained at \$90-95 per ton. Late in the year, however, the price rose to \$100. The fresh fish market price varied greatly both years though, fluctuating between \$80 and \$240 per ton.

#### *Pacific Mackerel*

A moratorium which went into effect in November 1970 limits the taking of Pacific mackerel to a 15% incidental catch in mixed loads of fish. The Pacific mackerel catches for both 1972 and 1973 were quite small: 54 tons in 1972 and 58 tons in 1973. All the fish were from mixed loads of jack and Pacific mackerel, usually caught at Cortez Bank. The 1972 year class seems to be a weak one, as in the preceding year, and although the strength of the 1973 year class is as yet unknown, it could be strong since part of the most recent good-sized year class (1970) has now reached spawning age.

#### *Market Squid*

Squid landings declined in 1972. Monterey reported very limited landings except in July, while southern California experienced a relatively good squid season. The year 1973 was an extremely bad year for squid fishermen since Monterey landings were minimal and southern California landings were poor.

#### *Pacific Herring*

Herring landings experienced a great upsurge in California in 1973. This was not due to any change in the status of the population, but rather to the introduction of a new market for herring. The fish are shipped frozen to Korea where the eggs are stripped from the fish and sold as a delicacy in Japan.

Of the 750 ton quota authorized for Tomales Bay during the 1972-73 season, 588 tons were landed before the California Department of Fish and Game closed the herring fishing season in that area. San Francisco, which had a 1,500 ton quota, reported landings of 434 tons. A new law has now gone into effect which allows 450 tons to be taken from Tomales Bay, and 500 tons from San Francisco Bay during the 1973-74 season.

Vickie Wine

**REVIEW OF PELAGIC WET FISHERIES 1974**

Total commercial landings of pelagic wet fishes increased in 1973, then decreased in 1974 (Table 1). The increase in 1973 was principally a result of growth of the anchovy reduction fishery. The decrease in 1974 reflected a decrease in landings of anchovies during the second half of the 1973-74 season and a late start by fishermen in the 1974-75 season. Landings of Pacific sardine and Pacific mackerel were almost nil, apparently as a result of compliance by fishermen with moratoria on those species.

**TABLE 1**  
**Landings of Pelagic Wet-Fishes in California in Tons; 1964-74**

Year	Sardine	Anchovy	Pacific Mackerel	Jack Mackerel	Herring	Market Squid	Total
1964.....	6,569	2,488	13,414	44,846	175	8,217	75,709
1965.....	962	2,866	3,525	33,333	258	9,310	50,254
1966.....	439	31,140	2,315	20,431	121	9,512	63,958
1967.....	74	34,805	583	19,090	136	9,801	64,489
1968.....	62	15,538	1,567	27,834	179	12,466	57,646
1969.....	53	67,639	1,179	25,961	85	10,390	105,307
1970.....	221	96,243	311	23,873	158	12,295	133,101
1971.....	149	44,853	78	29,941	120	15,756	90,947
1972.....	186	69,101	54	25,559	63	10,030	104,993
1973.....	76	131,919	28	10,308	1,410	6,031	149,772
1974*.....	4	82,585	31	11,038	2,609	11,817	108,084

\* Preliminary.

**Northern Anchovy**

The increase in anchovy landings for 1973 was a result of growth of the anchovy reduction fishery. Total landings for the 1973-74 reduction season were the highest in the 10 year history of the fishery (Table 2). Higher prices, ranging from \$41 to \$57.50 per ton of raw fish, and greater availability of anchovies than in the previous season stimulated more effort in the fishery.

**TABLE 2**  
**Anchovy Landings for Reduction in the Southern and Northern Permit Areas 1965-66 through 1973-74 in Tons**

Season	Southern Permit Area	Northern Permit Area	Total
1965-66 <sup>A</sup> .....	16,468	375	16,843
1966-67 <sup>B</sup> .....	29,589	8,021	37,610
1967-68 <sup>C</sup> .....	852	5,651	6,503
1968-69 <sup>D</sup> .....	25,314	2,736	28,050
1969-70.....	81,453	2,020	83,473
1970-71.....	80,095	657	80,752
1971-72.....	52,052	1,374	53,426
1972-73.....	73,167	2,352	75,519
1973-74.....	109,207	11,380	120,587

<sup>A</sup> November 12, 1965, through April 30, 1966.

<sup>B</sup> October 1, 1966, through April 30, 1967.

<sup>C</sup> September 15, 1967, through May 15, 1968.

<sup>D</sup> August 1 through May 15 (this season continues to date).

Landings in the northern permit area reached the

10,000 ton quota by the end of October 1973. At the request of Monterey processors, a 5,000 ton addition to the quota was authorized by the Fish and Game Commission, and the boundary between the northern and southern permit areas was moved approximately 50 miles north to Pt. Buchon. Landings for the northern permit area totaled 11,380 tons by the end of the season.

The southern permit area quota of 100,000 tons was met and the season closed for that area on February 28, 1974. This marked the first time in the 10 year history of the reduction fishery that the quota was reached. In March, the Fish and Game Commission increased the southern permit area quota to 120,000 tons with the provisions that no fish could be taken within 12 miles of the mainland and that the season would close 2 weeks early on April 30. Fishermen landed an additional 9,207 tons by the end of the shortened season.

A total of 15 boats, comprised of 2 purse seiners and 13 lampara boats, landed anchovies for reduction in the northern permit area. Thirty-eight boats landed anchovies for reduction in the southern permit area. Of this total, 35 were purse seiners and 3 were lampara boats. One purse seiner went aground and broke up at Port Hueneme in September.

The 1974-75 anchovy season began slowly in the southern permit area. No anchovies were landed at Terminal Island canneries due to a price dispute until the end of October. By the end of 1974, landings totaled 43,938 tons for the southern permit area and 4,134 tons for the northern permit area. Although the southern area quota reverted back to 100,000 tons, the 1973-74 northern area quota remained at 15,000 tons. Live bait fishermen had a poor year in 1973 when many of their catches consisted of "pinheads" (young of the year). Those "pinheads" apparently returned in 1974 as yearlings and helped to create an excellent year for bait fishermen. With very few exceptions, anchovies were large and readily available all year.

**Pacific Sardine**

A new law which prohibits the take of Pacific sardines for any purpose until the estimated spawning biomass reaches 20,000 tons went into effect in 1974. The law provides for an incidental catch not to exceed 15% of a boatload or lot, and sardines so captured may only be canned or reduced. Reported such landings totaled 4 tons in 1974 compared with 76 tons in 1973.

**Jack Mackerel**

Jack mackerel landings for 1974, although slightly higher than 1973 landings, continued to fall far below

a 12 year mean of 26,661 tons (Table 3). The relatively poor catches for 1973 and 1974 were possibly a result of poor weather (especially in 1973), lower effort due to greater availability of anchovies, and increased fuel costs. In January 1974, the largest cannery taking mackerel at Terminal Island burned down, an event which substantially reduced daily mackerel orders. Fishermen received \$90 to \$100 per ton in 1973 and \$115 per ton in 1974. Most of the jack mackerel landed in 1973 and 1974 was caught at San Clemente Island and Cortes Bank.

TABLE 3  
Commercial Landings of Jack Mackerel in California  
in Tons; 1963-74

Year	Annual landings	Mean annual landings
1963	47,721	
1964	44,846	46,284 (1963-64)
1965	33,333	41,967 (1963-65)
1966	20,431	36,583 (1963-66)
1967	19,090	33,084 (1963-67)
1968	27,834	32,209 (1963-68)
1969	25,961	31,317 (1963-69)
1970	23,873	30,386 (1963-70)
1971	29,941	30,337 (1963-71)
1972	25,559	29,589 (1963-72)
1973	10,308	28,082 (1963-73)
1974	11,038	26,661 (1963-74)

#### *Pacific Mackerel*

A moratorium on the commercial take of Pacific mackerel as part of management legislation enacted

in 1972 is still in effect. Although up to 18% by weight of a boatload or lot may contain incidentally caught Pacific mackerel, fishermen are complying with the moratorium. Reported landings totaled only 28 tons in 1973 and 31 tons in 1974.

#### *Market Squid*

Market squid landings for 1974 almost doubled those for 1973. Totals of 6,031 tons and 11,718 tons were landed for 1973 and 1974 respectively. The low 1973 total reflects the poor year for squid fishermen at Monterey. Statewide, fishermen received \$27 to \$200 per ton in 1973, but the majority of squid catches brought \$50 to \$60 per ton. Prices paid in 1974 ranged from \$50 to \$200 per ton with \$60 to \$80 per ton most commonly paid.

#### *Pacific Herring*

Pacific herring landings totaled 2,609 tons for 1974 compared with 1,410 tons for 1973. Almost all herring landed both years was taken in San Francisco, Monterey, and Tomales Bay. In 1974, a quota of 450 tons was imposed on the Tomales Bay fishery by the State Legislature, and for the first time the number of participating vessels was limited. The Tomales Bay quota was met on January 11 after only 8 days of fishing. A quota of 500 tons per spawning season was imposed on the San Francisco Bay herring fishery as well. That quota was met and the season closed on January 31 after approximately 2 weeks of fishing.

*Phil Lehtonen*

## PUBLICATIONS

July 1, 1973, to June 30, 1975

- Ahlstrom, E. H. 1974. The diverse patterns of metamorphosis in gonostomatid fishes: an aid to classification, p. 659-674. *In* J. H. Blaxter (ed.) The early life history of fish. Int. Symp. Dunstaffnage Mar. Res. Lab., Scot. Mar. Biol. Assoc., Oban, Scotland, May 17-23, 1973. Proc. Springer-Verlag, Berlin.
- Ally, J. R. Raymond. 1974. A description of the laboratory-reared first and second zoeae of *Portunus xantusii* (Stimpson) (Brachyura, Decapoda). *Calif. Fish and Game*, 60(2): 74-78
- \_\_\_\_\_. 1975. A description of the laboratory-reared larvae of *Cancer gracilis* Dana, 1852 (Decapoda, Brachyura). *Crustaceana*, 28(3): 231-246.
- Ally, J. R. Raymond, Ronald G. Evans and Thomas W. Thompson. 1975. The results of an exploratory fishing cruise for *Loligo opalescens* in southern and central California, June 5-25, 1974. *Calif. St. Univ. and Coll., Moss Landing Mar. Lab., Sea Grant Tech. Publ.*, (75-2): 1-22. (Moss Landing Mar. Lab., Contrib., (46).)
- Alvarino, Angeles. 1974a. Chaetognatha, p. 18-19. *In* Encyclopedia Britannica, Inc., 15th ed., Chicago.
- \_\_\_\_\_. 1974b. Distribution of siphonophores in the regions adjacent to the Suez and Panama Canals. *Fish Bull., U. S.*, 72(2): 527-546.
- Alvarez, S., and Richard A. Schwartzlose. 1973. Algunos problemas oceanologicos de los mares adyacentes a la peninsula de Baja California. *Calafia: Rev. Univ. Autonoma de Baja Calif.*, 2(2): 37-39.
- Beers, J. R. 1974a. Controlled ecosystem pollution experiment (CEPEX): Micro-zooplankton in the controlled environment pollution experiment. *Prog. Rept. Calif. Univ., IMR Ref.*, (74-10): Pts. 1 and 2.
- \_\_\_\_\_. 1974b. Think small! Protozoa in the world of the plankton. *Environ. Southwest*, (460): 1-7.
- Berman, T., and O. Holm-Hansen. 1974. Release of photo-assimilated carbon as dissolved organic matter by marine phytoplankton. *Mar. Biol.* 28: 305-310.
- Bezdek, H. F., and A. F. Carlucci. 1974. Concentrations and removal of microlayers from a seawater surface by bursting bubbles. *Limnol. Oceanogr.*, 19: 126-132.
- Brinton, Edward. 1973. Distributional atlas of Euphausiacea (Crustacea) in the California Current region. Pt. 2. *Mar. Res. Comm., Calif. Coop. Ocean. Fish. Invest., Atlas*, (18): 1-336
- \_\_\_\_\_. 1975. Euphausiids of Southeast Asian waters. *Univ. Calif., Naga Repts.*, 4(5): 1-256.
- Brinton, Edward, and K. Gopalakrishnan. 1973. The distribution of Indian Ocean euphausiids, p. 357-382. *In* B. Zeitzschel (ed.) The biology of the Indian Ocean: vol. 3, Ecological studies. Springer-Verlag, Berlin.
- Brown, J. F., and C. S. Cox. 1973. Design of light, cylindrical pressure cases. *Engl. J.*, 55: 35-37.
- Carlucci, A. F. 1973a. Bioassay: Biotin, p. 377-385; Cyanocobalamin, p. 387-394. *In* J. Stein (ed.) *Handbook of phycological methods*, Cambridge Univ. Press, New York.
- \_\_\_\_\_. 1974. Production and utilization of dissolved vitamins by marine phytoplankton, p. 449-456. *In* R. R. Colwell and R. Y. Morita (eds.) Effect of the ocean environment on microbial activities. University Park Press, Baltimore.
- Carlucci, A. F., and S. L. Shimp. 1974. Isolation and growth of a marine bacterium in low concentrations of substrate, p. 362-367. *In* R. R. Colwell and R. Y. Morita (eds.) Effect of the ocean environment on microbial activities. University Park Press, Baltimore.
- Cheng, Lanna. 1973a. Can *Halobates* dodge nets? I. By daylight? *Limnol. Oceanogr.*, 18(4): 663-665.
- \_\_\_\_\_. 1973b. *Halobates*. *Oceanogr. and Mar. Biol., Ann. Rev.*, 11: 223-235.
- \_\_\_\_\_. 1973c. The ocean strider *Halobates* (Heteroptera: Gerridae) in the Atlantic Ocean. *Oceanologia*, 13(4): 683-690. (in Russian)
- \_\_\_\_\_. 1973d. Some *Halobates* from the Pacific Ocean. *Jap. J. Zool.*, 17(1): 11-15.
- \_\_\_\_\_. 1974a. Fluidization as a feeding mechanism by beach flies (Diptera: Ephydriidae). *Nature*, 250(5462): 167-168.
- \_\_\_\_\_. 1974b. *Halobates* from the north-west African area. *Span. Inst. Invest. Pesq., Result. Exped. Cient. Cornide de Saavedra*, 3: 169-171.
- \_\_\_\_\_. 1974c. Notes on the ecology of the oceanic insect *Halobates*. *Mar. Fish. Rev.*, 36(2): 1-7.
- \_\_\_\_\_. 1975a. Marine pleuston—animals at the sea-air interface. *Oceanogr. and Mar. Biol., Ann. Rev.*, 13: 181-212.
- \_\_\_\_\_. 1975b. Zooplankton identification for pelagic *Halobates*. Insecta. Heteroptera, Gerridae. *Cons. Perm. Int. Explor. de la Mer, Zooplankton Identification Sheet* (147).
- Cheng, Lanna, and J. T. Enright. 1973. Can *Halobates* dodge nets. 2. by moonlight? *Limnol. Oceanogr.*, 18(4): 666-669.
- Chow, T. J. 1974. Lead pollution: An assessment for the Los Angeles coastal zone, p. 110-113. *In* W. B. Merselis (ed.) Symposium on coastal zone management and the western states future. Los Angeles, Dec. 3-4, 1973. *Mar. Tech. Soc., L. A. Reg. Sec., Proc. Mar. Tech. Soc., Wash., D.C.*
- Chow, T. J., K. Bruland, K. Bertine, A. Soutar, M. Koide and E. D. Goldberg. 1973. Lead pollution: Records in southern California coastal sediments. *Science*, 181: 551-552.
- Chow, T. J., C. C. Patterson and D. Settle. 1974. Occurrence of lead in tuna. *Nature*, 251: 159-161.
- Chow, T. J., C. B. Snyder and J. L. Earl. 1974. Isotope ratios of lead as pollutant source indicator. *In* FAO/IAEA Joint symposium on isotope ratios as pollutant source and behavior indicators, Proc., Vienna, November 18-22.
- Clark, N. E., L. Eber, R. M. Laurs, J. A. Renner and J. F. T. Saur. 1974. Heat exchange between ocean and atmosphere in the eastern north Pacific for 1961-71. *U. S. NOAA Tech. Rept., NMFS, SSRF*, (682): 1-108.
- Cox, C. S. 1974. Refraction and reflection of light at the sea surface, p. 51-75. *In* N. G. Jerlov and E. S. Nielsen (eds.) Optical aspects of oceanography. Academic Press, New York.
- Cox, C. S., and J. H. Filloux. 1974. Two dimensional numerical models of the California electromagnetic coastal anomaly. *J. Geomag. Geoelectr.*, 26: 257-267.
- Cox, C. S., M. C. Gregg and P. W. Hacker. 1973. Vertical microstructure measurements in the central north Pacific. *J. Phys. Oceanogr.*, 3(4): 458-469.
- Crooke, Stephen J. 1973. The first occurrence of *Kyphosus analoga* in California. *Calif. Fish and Game*, 59(4): 310-311.
- Dayton, Paul K. 1973a. Dispersion, dispersal and persistence of the annual intertidal alga, *Postelsia palmaeformis* Ruprecht. *Ecology*, 52(2): 433-438.
- \_\_\_\_\_. 1973b. Two cases of resource partitioning in an intertidal community: Making the right prediction for the wrong reason. *Amer. Nat.*, 107: 662-670.
- \_\_\_\_\_. 1974. Kelp communities of southern South America. *Antarct. J. of U.S.*, 9: 22-23.
- \_\_\_\_\_. 1975a. Experimental evaluation of ecological dominance in a rocky intertidal algal community. *Ecol. Monogr.*, 45(2): 137-159.

- \_\_\_\_\_. 1975b. Experimental studies of algal canopy interactions in a sea otter-dominated kelp community at Amchitka Island, Alaska. *Fish. Bull.*, U. S., 73: 230-237.
- Dayton, Paul K., R. J. Rosenthal and L. C. Mahan. 1973. Kelp communities in the Chilean archipelago: R/V *Hero* cruise 72-5. *Antarct. J. of U. S.*, 8(2): 34-35.
- Dayton, Paul K., G. A. Robilliard, R. T. Paine and L. B. Dayton. 1974. Biological accommodation in the benthic community at McMurdo Sound, Antarctica. *Ecol. Monogr.*, 44: 105-128.
- Eber, L. E. 1973. Subpoint prediction for direct readout meteorological satellites. U. S. NOAA Tech. Rept., NMFS, SSRF, (669): 1-7.
- Fenical, W. H. 1974. Rhodophytin, a halogenated vinyl peroxide of marine origin. *Amer. Chem. Soc. J.*, 96: 5580-5581.
- Fenical, W. H., and J. J. Sims. 1974. Cycloedesmol, an antibiotic cyclopropane containing sesquiterpene from the marine alga, *Chondria oppositoclada* Dawson. *Tetrahedron Lett.*, 13: 1137-1140.
- Fenical, W. H., K. B. Gifkins and J. Clardy. 1974. X-ray determination of chondriol; a reassignment of structure. *Tetrahedron Lett.*, 16: 1507-1510.
- Fenical, W. H., J. J. Sims, D. Squatrito, R. M. Wing and P. Radlick. 1973. Marine natural products. 7. Zonarol and isozonarol, fungitoxic hydroquinones from the brown seaweed, *Dictyosphaeria zonarioides*. *J. Org. Chem.*, 38(13): 2383-2386. (Also in: Proc. 3rd Inter. Conf. on Food-Drugs from the sea, Kingston, R.I., Aug. 1972).
- Fenical, W. H., J. J. Sims, R. M. Wing and P. Radlick. 1973. Marine natural products. 6. Chondriol, a novel acetylenic sesquiterpene from red alga *Chondria oppositoclada*. *Tetrahedron Lett.*, 4: 313-316.
- Fleming, Eugene. 1974. Review of the pelagic wet-fisheries for 1972. *Mar. Res. Comm., Calif. Coop. Fish. Invest. Rept.*, 17: 31-32.
- Fleminger, Abraham. 1973. Pattern, number, variability and taxonomic significance of integumental organs (sensilla and glandular pores) in the genus *Eucalanus* (Copepoda: Calanoida). *Fish. Bull. U.S.*, 71(4): 965-1010.
- \_\_\_\_\_. 1974. Prevalent biogeographic patterns in marine eipelagic zooplankton. *Amer. Soc. Zool.*, 14(4): 1274. (Abstr.)
- Fleminger, Abraham, and K. Hulsemann. 1974. Systematics and distribution of the four sibling species comprising the genus *Pontellina* Dana (Copepoda: Calanoida). *Fish. Bull., U.S.*, 72(1): 63-120.
- \_\_\_\_\_. 1975. Some aspects of copepodid development in the genus *Pontellina* Dana (Copepoda: Calanoida). *Bull. Mar. Sci.*, 25(2): 174-185.
- Fleminger, A., J. D. Isaacs and J. G. Wyllie. 1974. Zooplankton biomass measurements from CalCOFI cruises of July 1955 to 1959 and remarks on comparison with results from October, January and April cruises of 1955 to 1959. *Mar. Res. Comm., Calif. Coop. Fish. Invest., Atlas*, (21): 1-118.
- Foster, Theodore D., and William C. Patzert. 1973. CATO expedition—leg 6. *Nav. Res. Rev.*, July: p. 30-31.
- Fox, William W., Jr. 1973. A general life history exploited population simulator with pandalid shrimp as an example. *Fish Bull., U.S.*, 71(4): 1019-1028.
- \_\_\_\_\_. 1975. Fitting the generalized stock production model by least-squares and equilibrium approximation. *Fish Bull., U.S.*, 73(1): 23-37.
- Frey, Herbert W., and Eric H. Knaggs. 1973. Status of Pacific mackerel spawning population, 1973. *Calif. Dept. Fish and Game, Mar. Res. Adm. Rept.*, (73-7): 1-16.
- Ganssle, David. 1973. The status of the northern anchovy resource and its management. *Calif. Dept. Fish and Game, Mar. Res. Tech. Rept.*, (5): 1-14.
- Gates, Doyle E., and Herbert W. Frey. 1974. Designated common names of certain marine organisms of California. *Calif. Dept. Fish and Game, Fish Bull.*, (161): 55-90.
- Guillen, Oscar, J. L. Earl and T. J. Chow. 1974. Chemical analysis of Peruvian guano. *Peru Minist. Pesq., Documenta*.
- Hardwick, James E. 1973. Biomass estimates of spawning herring, *Clupea herengus pallasii*, herring eggs, and associated vegetation in Tomales Bay. *Calif. Fish and Game*, 59(1): 36-61.
- Haugen, Charles W. 1973. The status of the Pacific sardine resource and its management. *Calif. Dept. Fish and Game, Mar. Res. Tech. Rept.*, (13): 1-15.
- Hessler, Robert R. 1974. The structure of deep benthic communities from central oceanic waters, p. 79-93. *In* C. B. Miller (ed.) *The biology of the oceanic Pacific: Proc. 33rd Ann. Biol. Colloq.* Oregon St. Univ. Press, Corvallis.
- Hessler, Robert R., and Peter A. Jumars. 1974. Abyssal community analysis from replicate box cores in the central North Pacific. *Deep-Sea Res.*, 21: 185-209.
- Hessler, Robert R., and Howard L. Sanders. 1973. Two new species of *Sandersiella* (Cephalocarida), including one from the deep sea. *Crustaceana*, 24(2): 181-196.
- Hirschfeld, D. R., W. H. Fenical, G. H. Y. Lin, R. M. Wing, P. Radlick and J. J. Sims. 1973. Marine natural products. 8. Pachydictyol A, an exceptional diterpene alcohol from brown alga *Pachydictyon coriaceum*. *Amer. Chem. Soc. J.*, 95: 4049.
- Hom, W., A. Soutar, R. W. Risebrough and D. R. Young. 1974. Deposition of DDE and polychlorinated biphenyls in dated sediments of the Santa Barbara basin. *Science*, 184: 1197-1199.
- Hunter, J. R., and G. L. Thomas. 1974. Effect of prey distribution and density on the searching and feeding behavior of larval anchovy *Engraulis mordax* Girard, p. 559-574. *In* J. H. S. Blaxter (ed.) *The early life history of fish*. Int. Symp. Dunstaffnage Mar. Res. Lab., Scot. Mar. Biol. Assoc., Oban, Scotland, May 17-23, Proc. Springer-Verlag, Berlin.
- Isaacs, John D. 1973a. The ocean margins, p. 76-93. *In* T. Saunders English (ed.) *Ocean resources and public policy*. Univ. Wash. Press, Seattle, (Seminar, 21 Feb. 1968).
- \_\_\_\_\_. 1973b. Potential trophic biomasses and trace-substance concentrations in unstructured marine food webs. *Mar. Biol.*, 22: 97-104.
- Isaacs, J. D., and R. A. Schwartzlose. 1975. Biological applications of underwater photography. *Oceanus*, 18(3): 24-30.
- Isaacs, J. D., and G. L. Wick. 1973. Optimized tactics for open-water marine predators. *Mar. Biol. Ass., India, Spec. Publ.*: 193-199.
- Isaacs, John D., Sargun A. Tont and Gerald L. Wick. 1974. Deep scattering layers: Vertical migration as a tactic for finding food. *Deep-Sea Res.*, 21: 651-656.
- Isaacs, J. D., J. W. Stork, D. B. Goldstein and G. L. Wick. 1975. Effect of vorticity pollution by motor vehicles on tornadoes. *Nature*, 253 (5489): 254-255.
- Johnson, David A., Scott E. McDowell, Joseph L. Reid and William C. Patzert. 1974. On the flow of Antarctic bottom water through the Vema Channel. *Geol. Soc. Amer. Ann. Meet., Abstr. with Programs*, 6(7): 811.
- Johnson, Martin W. 1974. On the dispersal of lobster larvae into the east Pacific barrier (Decapoda, Palinuridea). *Fish. Bull., U.S.*, 73(3): 639-647.
- Johnson, Martin W., and Margaret D. Knight. 1975. A supplementary note on the larvae of *Scyllarides astori* Holthuis (Decapoda, Scyllaridae). *Crustaceana*, 28(1): 109-112.
- Kimura, Makoto. 1973. Inconsistencies in locating the first annulus of Pacific sardines. *Calif. Fish and Game*, 59(3): 191-195.
- Kittredge, J. S., Francis T. Takahashi, James Lindsey and Reuben Lasker. 1974. Chemical signals in the sea: Marine allelochemics and evolution. *Fish. Bull., U.S.*, 72(1): 1-11.
- Klingbeil, Richard A. 1974. Average lunar monthly catch of sardines in California for the 1954-55 through 1961-62 seasons. *Calif. Dept. Fish and Game, Mar. Res. Tech. Rept.*, (26): 1-43.
- Knaggs, Eric H. 1973. The status of the jack mackerel resource and its management. *Calif. Dept. Fish and Game, Mar. Res. Tech. Rept.*, (11): 1-12.

- \_\_\_\_\_. 1974a. The southern California jack mackerel fishery and age composition of the catch for the 1947-48 through 1956-57 seasons. Calif. Dept. Fish and Game, Mar. Res. Tech. Rept., (22): 1-47.
- \_\_\_\_\_. 1974b. The southern California jack mackerel fishery and age composition of the catch for the 1957-58 through 1961-62 seasons. Calif. Dept. Fish and Game, Mar. Res. Tech. Rept., (24): 1-25.
- \_\_\_\_\_. 1974c. Status of Pacific mackerel spawning population, 1974. Calif. Dept. Fish and Game, Pac. Mackerel Ann. Rept. (2), Mar. Res. Admin. Rept., (5): 1-10.
- Knaggs, Eric H., and P. A. Barnett. 1975. The southern California jack mackerel fishery and age composition of the catch for the 1962-63 through 1966-67 seasons. Calif. Dept. Fish and Game, Mar. Res. Tech. Rept., (28): 1-28.
- Knaggs, Eric H., and Richard H. Parrish. 1973. Maturation and growth of Pacific mackerel, *Scomber japonicus* Houttuyn. Calif. Dept. Fish and Game, Mar. Res. Tech. Rept., (3): 1-19. (Also: Calif. Fish and Game, 59(2): 114-120.)
- Knaggs, Eric H., and J. S. Sunada. 1974. Validity of otolith age determinations for jack mackerel, *Trachurus symmetricus*, from the southern California bight area. Calif. Dept. Fish and Game, Mar. Res. Tech. Rept. (21): 1-11.
- Knight, Margaret D. 1975. The larval development of Pacific *Euphausia gibboides* (Euphausiacea). Fish. Bull., U.S., 73(1): 145-168.
- Krishnaswami, S., A. Soutar, D. Lal and B. S. Amin. 1973. Geochronological studies in Santa Barbara basin:  $^{55}\text{Fe}$  as a unique tracer for particulate settling. Limnol. Oceanogr., 18(5): 763-770.
- Lam, Ron K. 1974a. Atoll permeability calculated from tidal diffusion. J. Geophys. Res., 79(21): 3073-3081.
- \_\_\_\_\_. 1974b. Current measurements off the California coast, 1972. Scripps Inst. Oceanogr., SIO Ref. Ser., (74-12).
- \_\_\_\_\_. 1974c. Swains Island tide measurements, April-May 1970. Scripps Inst. Oceanogr., SIO Ref. Ser., (74-11).
- Lauris, R. Michael, and Ronald J. Lynn. 1975. The association of oceanic boundary features and albacore tuna in the northeast Pacific. STD Conf. and Workshop, Feb. 12-14, 1975, San Diego, Proc.: 23-30.
- Lee, R. F. and Lanna Cheng. 1974. A comparative study of the lipids of water-striders from marine, estuarine and freshwater environments: *Halobates*, *Rheumatobates*, *Gerris* (Heteroptera: Gerridae). Limnol. Oceanogr., 19(6): 958-965.
- Lee, R. F., J. T. Polhemus and Lanna Cheng. 1975. Lipids of the waterstrider *Gerris remigis* Say (Heteroptera: Gerridae): seasonal and developmental variations. Comp. Biochem. Physiol., 51(B): 451-456.
- Lenarz, William H. 1974. Length-weight relations for five eastern tropical Atlantic scombrids. Fish. Bull., U.S., 72(3): 848-851.
- Lenarz, William H., and Eugene L. Nakamura. 1974. Analysis of length and weight data on three species of billfish from the western Atlantic Ocean. Int. Billfish Symp., Kailua-Kona, Hawaii, 9-12 August 1972. Proc., pt. 2. Review and Contr. Pap. U.S. NOAA, Tech. Rept., SSRF, (675): 121-125.
- Lenarz, W. H., W. W. Fox, Jr., G. T. Sakagawa and B. J. Rothschild. 1974. An examination of the yield per recruit basis for a minimum size regulation for Atlantic yellowfin tuna, *Thunnus albacares*. Fish. Bull., U.S., 72(1): 37-61.
- Lenarz, W. H., F. J. Mather, III, J. S. Beckett, A. C. Jones and J. Mason. 1973. Estimation of rates of tag shedding by northwest Atlantic bluefin tuna. Fish. Bull., U.S., 71(4): 1103-1105.
- Linley, J. R., and Lanna Cheng. 1974. The grooming organs of *Culicoides* (Diptera: Ceratopogonidae). Mosquito News, 34(2): 204-206.
- MacCall, Alec D. 1973a. The mortality rate of *Engraulis mordax* in southern California. Calif. Dept. Fish and Game, Mar. Res. Tech. Rept. (4): 1-23.
- \_\_\_\_\_. 1973b. The status of the Pacific mackerel resource and its management. Calif. Dept. Fish and Game, Mar. Res. Tech. Rept., (12): 1-13.
- \_\_\_\_\_. 1974. The mortality rate of *Engraulis mordax* in southern California. Calif. Mar. Res. Comm., Calif. Coop. Ocean. Fish. Invest., Rept., 17: 131-135.
- McGowan, John A. 1974. The nature of oceanic ecosystems, p. 9-28. In Charles Miller (ed.) The biology of the oceanic Pacific: Proc. 33rd Ann. Biol. Colloq. Oregon St. Univ. Press, Corvallis.
- McGowan, John A., and Peter M. Williams. 1973. Oceanic habitat differences in the North Pacific. J. Exp. Mar. Biol. and Ecol., 12: 187-217.
- MacGregor, John S. 1974. Changes in the amount and proportions of DDT and its metabolites, DDE and DDD, in the marine environment off southern California, 1949-72. Fish. Bull., U.S., 72(2): 275-293.
- Mague, T. H., and O. Holm-Hansen. 1975. Nitrogen fixation on a coral reef. Phycologia, 14(2): 87-92.
- Mais, Kenneth F. 1973. California Department of Fish and Game Fisheries Resources Sea Survey Cruises, 1972. Mar. Res. Comm., Calif. Coop. Ocean. Fish. Invest., Data Rept., (22): 1-88.
- \_\_\_\_\_. 1974. Pelagic fish surveys in the California Current. Calif. Dept. Fish and Game, Fish Bull., (162): 1-79.
- Maxwell, William D. 1974. A history of the California live-bait fishing industry. Calif. Dept. Fish and Game, Mar. Res. Tech. Rept., (27): 1-24.
- \_\_\_\_\_. 1975. The croakers of California. Calif. Dept. Fish and Game, Mar. Res. Leaflet, (8): 1-16.
- Moser, H. Geoffrey. 1974. Development and distribution of larvae and juveniles of *Sebastolobus* (Pisces; family Scorpaenidae). Fish. Bull., U.S., 72(4): 865-884.
- Moser, H. Geoffrey, and Elbert H. Ahlstrom. 1974. Role of larval stages in systematic investigations of marine teleosts: The Myctophidae, a case study. Fish. Bull., U.S., 72(2): 391-413.
- Moser, H. G., E. H. Ahlstrom, D. Kramer and E. Stevens. 1974. Distribution and abundance of fish eggs and larvae in the Gulf of California. Mar. Res. Comm., Calif. Coop. Ocean. Fish. Invest., Rept., 17: 112-128.
- Mudie, Peta J. 1974. The potential economic uses of halophytes, p. 565-597. In Reinhold, Robert J. and William H. Queen (eds.) Ecology of halophytes. Academic Press, New York.
- Mudie, Peta J., Bruce Browning and John Speth. 1974. The natural resources of Los Peñasquitos Lagoon and recommendations for use and development. Calif. Dept. Fish and Game, Coastal Wetland Ser., (7): 3-75.
- Nemoto, Takahisa, Edward Brinton and Masakuni Araki. 1973. Clinal variation in the frequency of one- and two-spined forms of *Thysanoessa inermis* (Krøyer, 1849) (Euphausiacea) in the North Pacific. Crustaceana, 24(3): 318-322.
- Norberg, Ralph H. 1974. Review of the pelagic wet-fisheries for 1971 and 1972. Mar. Res. Comm., Calif. Coop. Ocean. Fish. Invest. Rept., 17: 30-31.
- Owen, Robert W., Jr. 1973. The effect of particles of light scattering in the sea. Oceanogr. Soc. Jap., J., 29: 171-184.
- \_\_\_\_\_. 1974a. Distribution of primary production, plant pigments, and secchi depth in the California Current region, 1969. Mar. Res. Comm., Calif. Coop. Ocean. Fish. Invest., Atlas, (20): 11-14, 20 charts.
- \_\_\_\_\_. 1974b. Optically effective area of particle ensembles in the sea. Limnol. Oceanogr., 19(4): 584-590.
- Owen, R. W., Jr., and C. K. Sanchez. 1974. Phytoplankton pigment and production measurements in the California Current region, 1969-72. U.S. NOAA, NMFS, Data Rept., (91): 1-185.
- Parrish, Richard H. 1973. The California sablefish fishery for the period 1953-1969. Calif. Fish and Game, 59(3): 168-177.
- \_\_\_\_\_. 1974. Exploitation and recruitment of Pacific mackerel, *Scomber japonicus*, in the northeastern Pacific. Mar. Res. Comm., Calif. Coop. Ocean. Fish. Invest., Rept., 17: 136-140.

- Patzert, William C. 1973. Current meter data: An indication of either subtropical countercurrent or anticyclonic island circulation. *J. Geophys. Res.*, 78(33): 7919-7922.
- \_\_\_\_\_. 1974a. Seasonal reversal in Red Sea circulation, p. 55-89. *In* Cent. Nat. Explor. Ocean (CNEOX), Publ., Ser.: Actes de Colloques, 2. Symp. Ass. Int. Sci., Physiq. Ocean (IAPSO), Paris.
- \_\_\_\_\_. 1974b. Volume and heat transports between the Red Sea and the Gulf of Aden, and notes on the Red Sea heat budget, p. 191-201. *ibid.*
- \_\_\_\_\_. 1974c. Wind-induced reversal in Red Sea circulation. *Deep-Sea Res.*, 21: 109-121.
- Patzert, William C., and K. Wyrski. 1974. Anticyclonic flow around the Hawaiian Islands indicated by current meter data. *J. Phys. Oceanogr.*, 4(4): 673-676.
- Pedrin, Oscar, and Howard Shainberg. 1974. A brief survey of the sardine and anchovy populations at Vizcaino Bay, and the sardine fishery of Cedros Island, Baja California. *Calif. Fish and Game*, 60(4): 199-204.
- Perrin, W. F., R. W. Warner, C. L. Fiscus and D. B. Holts. 1973. Stomach contents of porpoise, *Stenella* spp., and yellowfin tuna, *Thunnus albacares*, in mixed-species aggregations. *Fish Bull.*, U.S., 71(4): 1077-1092.
- Provasoli, L., and A. F. Carlucci. 1974. Vitamins and growth regulators, p. 741-787. *In* W. D. P. Steward (ed.) *Algal physiology and biochemistry*. Blackwell Scientific Publ., Oxford.
- Pulsifer, Janet. 1975. Some techniques for mounting copepods for examination in a scanning electron microscope. *Crustaceana* 28(1): 101-105.
- Reid, Joseph L. 1973a. Deep ocean circulation, p. 203-217. *In* Richard C. Vetter (ed.) *Oceanography: The last frontier*. Basic Books, Inc., New York. (Also paperback ed. *Voice of Amer. Forum Ser.*, Wash. D.C., 1974.)
- \_\_\_\_\_. 1973b. Northwest Pacific Ocean waters in winter. *Johns Hopkins Oceanogr. Stud.*, 5: 1-96.
- \_\_\_\_\_. 1974. Deep Pacific circulation inferred from the density-field and water characteristics. *Amer. Geophys. Union, Trans.*, 56(12): 1134. (Abstr.)
- \_\_\_\_\_. 1975. A review of the physical oceanography of the southern California offshore region, p. 91. *In* Robert J. Lavenberg and Sylvia A. Earle (eds.) *Recommendation for baseline research in southern California relative to offshore resource development*, Conf. and Workshop, Long Beach, Calif. 5-7 Dec. 1974. *So. Calif. Acad. Sci., Proc., Spec. Pub.*: 1-258. (Abstr.)
- Reid, Joseph L., and Peter F. Lonsdale. 1974. On the flow of water through the Samoan passage. *J. Phys. Oceanogr.*, 4(1): 58-73.
- Reid, J. L., W. D. Nowlin, H. J. McLellan and W. C. Patzert. 1973. Deep and bottom flow in the southwest Atlantic. *Amer. Geophys. Union, Trans.*, 54(4): 313. (Abstr.)
- Rothschild, B. J. 1973. Questions of strategy in fishery management and development. *Fish. Res. Bd. Can.*, J., 30(12) pt. 2: 2017-2030.
- \_\_\_\_\_. 1974. Fishery potential from the oceanic regions, p. 95-106. *In* Charles B. Miller (ed.) *The biology of the oceanic Pacific*. Proc. 33rd Ann. Biol. Colloq. Oregon St. Univ. Press, Corvallis.
- Sakagawa, Gary T. 1974. Participation by Panamanian and U.S. seiners in 1972 tuna fishery of the eastern tropical Atlantic. *Mar. Fish. Rev.*, 36(3): 10-13.
- \_\_\_\_\_. 1975. The purse seine fishery for bluefin tuna in the northwestern Atlantic Ocean. *Mar. Fish. Rev.*, 37(3): 1-8.
- Schmitt, W. R., C. K. Stidd and J. D. Isaacs. 1975. Ice ages and northern forests, p. 117-119. *In* G. Weller and S. A. Bowling (eds.) *Climate of the Arctic*. Geophys. Inst., Univ. Alaska Press, College, Alaska.
- Schulenberg, E., and R. Hessler. 1974. Scavenging abyssal benthic amphipods trapped under oligotrophic central North Pacific gyre waters. *Mar. Biol.*, 28: 185-187.
- Sessions, M. H., W. R. Gryan and T. P. Barnett. 1974. AXBT calibration and operation for NORPAX pole experiment. *Scripps Inst. Oceanogr. SIO Ref.*, (74-31).
- Seymour, R. J., and J. D. Isaacs. 1974. Tethered float breakwaters, p. 55-72. *In* T. Kowalski (ed.) *Floating Breakwater Conference*, Newport, R.I., 23-25 April, Proc., R.I. Univ., Mar. Tech. Rept. Ser., (24). (Also *Calif. Univ. Inst. Mar. Res.*, IMR Ref., (74-9) and *Sea Grant Publ.* (30)).
- Sholkovitz, E., and A. Soutar. 1975. Changes in the composition of the bottom water of the Santa Barbara basin: Effect of turbidity currents. *Deep-Sea Res.*, 22: 13-21.
- Sims, J. J., W. H. Fenical, R. M. Wing, and P. Radlick. 1973. Marine natural products. 4. Prepacifenol, a unique sesquiterpene and precursor to pacifenol. *Amer. Chem. Soc., J.*, 95: 972.
- Sims, J. J., C. H. Y. Lin, R. M. Wing and W. H. Fenical. 1973. Marine natural products. 9. Concinndiol, a bromo-diterpene alcohol from the red alga, *Laurencia concinna*. *Chem. Soc. (London) Chem. Comm., J.*: 470-471.
- Smith, K. L., Jr., and R. R. Hessler. 1974. Respiration of benthopelagic fishes: In situ measurements at 1230 meters. *Science*, 184: 72-73.
- Smith, Paul E. 1974. Distribution of zooplankton volumes in the California Current region, 1969. *Mar. Res. Comm., Calif. Coop. Ocean. Fish. Invest., Atlas*, (20): 15-17, 8 charts.
- Soutar, A., and J. D. Isaacs. 1974. Abundance of pelagic fish during the 19th and 20th centuries as recorded in anaerobic sediment off the Californias. *Fish. Bull.*, U.S., 72(2): 257-274.
- Spratt, Jerome D. 1973a. Age and length composition of northern anchovies (*Engraulis mordax*) landed in California for reduction during the 1970-71 season. *Calif. Fish and Game*, 59(2): 121-123.
- \_\_\_\_\_. 1973b. Age and length composition of northern anchovies, *Engraulis mordax*, in the California reduction fishery for the 1971-72 season. *Calif. Fish and Game*, 59(4): 293-298.
- Squire, James L., Jr. 1974a. Angler catch rates of billfishes in the Pacific Ocean. *Int. Billfish Sump., Kailua-Kona, Hawaii*, 9-12 Aug. 1972, Proc., pt. 2. Review and Contrib. Pap. U.S. NOAA Tech. Rept., NMFS SSRF, (675): 290-295.
- \_\_\_\_\_. 1974b. Catch distribution and related sea surface temperature for striped marlin (*Tetrapturus audax*) caught off San Diego, Calif. *ibid.* U.S. NOAA Tech. Rept., NMFS SSRF, (675): 188-193.
- \_\_\_\_\_. 1974c. Migration patterns of Istiophoridae in the Pacific Ocean as determined by cooperative tagging programs. *ibid.* U.S. NOAA Tech. Rept., NMFS SSRF, (675): 226-237.
- Stewart, G. L., J. R. Beers and C. Knox. 1973. Application of holographic techniques to the study of marine plankton in the field and in the laboratory. *Soc. Photo-Opt. Instrum. Eng., Proc.*, 41: 183-188.
- Sunada, John S. 1974. Age and growth of the Pacific saury, *Cololabis saira*. *Calif. Fish and Game*, 60(2): 64-73.
- \_\_\_\_\_. 1975. Age and length composition of northern anchovies, *Engraulis mordax*, in the 1972-73 season California anchovy reduction fishing. *Calif. Fish and Game*, 61(3): 133-143.
- Sunada, John S., Eric H. Knaggs and Robert N. Lea. 1975. Notes on some fishes collected off the outer coast of Baja California. *Calif. Fish and Game*, 61(1): 57-59.
- Tasto, Robert N. 1973. A status report on the jack mackerel tagging program. *Calif. Dept. Fish and Game, Mar. Res. Adm. Rept.*, (73-8): 1-8.
- \_\_\_\_\_. 1974. Marine bivalves of the California coast. *Calif. Dept. Fish and Game, Mar. Res. Leaf.*, (6): 1-23.
- Taft, B. A., B. M. Hickey, C. Wunsch and D. J. Baker, Jr. 1974. Undercurrent and deeper flows in the central Pacific. *Deep-Sea Res.*, 21: 403-430.
- Taft, B. A., A. R. Robinson and W. J. Schmitz, Jr. 1973. Current path and bottom velocity of the Kuroshio. *J. Phys. Ocean.*, 3: 347-350.
- Theilacker, G. H., and R. Lasker. 1974. Laboratory studies of predation by euphausiid shrimps on fish larvae, p. 287-299. *In* J. H. S. Blaxter (ed.) *The early life history of fish*. Int. Symp. Dunstaffnage Mar. Res. Lab., Scot. Mar. Biol. Ass., Oban, Scotland, May 17-23, Proc. Springer-Verlag, Berlin.



- Thiel, Hjalmar, and Robert R. Hessler. 1974. Ferngesteuertes Unterwasserfahrzeug erforscht Tiefseeboden UMSCHAU in Wissenschaft und Technik 74, 14: 451-453.
- Tont, Sargun A., and Gerald L. Wick. 1973. Response of a deep scattering layer to the 1972 total solar eclipse. Deep-Sea Res., 20: 769-771.
- Tsuchiya, Mizuki. 1974a. Variation of the surface geostrophic flow in the eastern intertropical Pacific Ocean. Fish. Bull., U.S., 72(4): 1075-1086.
- \_\_\_\_\_. 1974b. Reply (to S. Levitus comment on "Subsurface north equatorial counter-current in the eastern Pacific Ocean" by M. Tsuchiya). J. Geophys. Res., 79(18): 2759-2760.
- Veeh, H. H., A. Soutar and W. C. Burnett. 1973. Contemporary phosphorites on the continental margin of Peru. Science, 181: 844-845.
- Vlymen, William J., III. 1974. Swimming energetics of the larval anchovy, *Engraulis mordax*. Fish. Bull., U.S., 72(4): 885-899.
- Weare, N. M., F. Azam, T. H. Mague and O. Holm-Hansen. 1974. Micro-autoradiographic studies of the marine phycobionts *Rhizosolenia* and *Richelia*. J. Phycol., 10(3): 369-371.
- Wick, Gerald L. 1974a. Earth 2020. New Sci., 63(915): 747-748.
- \_\_\_\_\_. 1974b. Isotope separation. *Ibid.*, 63(911): 470-471.
- \_\_\_\_\_. 1974c. The lesson of L.A. *Ibid.*, 64(926): 758-759.
- \_\_\_\_\_. 1974d. Salinity power. *Ibid.*, 64(922): 434-435.
- \_\_\_\_\_. 1974e. Suspicious limit free ocean research. Los Angeles Times, 21 Jul. 1974, pt. 8, p. 5.
- \_\_\_\_\_. 1975a. A boost for alcohol. New Sci., 65(933): 220-221.
- \_\_\_\_\_. 1975b. The genesis of a tornado. *Ibid.*, 65(936): 396-397.
- \_\_\_\_\_. 1975c. Proposition 20. *Ibid.*, 66(946): 207-208.
- \_\_\_\_\_. 1975d. Salt in the earth. *Ibid.*, 65(941): 729-730.
- \_\_\_\_\_. 1975e. Take squid now. *Ibid.*, 66(951): 519.
- Wick, G. L., and J. D. Isaacs. 1974. Tungus event revisited. Nature, 247(5437): 139.
- Wilson, George D., and Robert R. Hessler. 1974. Some unusual Paraselloidea (Isopoda, Asellota) from the deep benthos of the Atlantic. Crustaceana, 27(1): 47-67.
- Wooster, Warren S., and Oscar Guillen. 1974. Características de "El Niño" en 1972. Inst. del Mar del Perú, Bol., 3(2): 44-71. (Also, J. Mar. Res., 32(3): 387-404. (In English))
- Young, D. R., J. D. Isaacs, J. N. Johnson and A. Soutar. 1973. Mercury concentrations in dated varved marine sediments collected off southern California. Nature, 244(5415): 273-275.



**Part II**

**SYMPOSIA OF THE CALCOFI CONFERENCE**

**SAN CLEMENTE, CALIFORNIA**

**NOVEMBER 4-7, 1973**

**A. FISHERY SCIENCE: FACT, FICTION, AND DOGMA**



## CATCH-PER-UNIT-OF-EFFORT: FACT, FICTION, OR DOGMA

JOHN RADOVICH

California Department of Fish and Game

I assumed this symposium is entitled FISHERY SCIENCE: Fact, Fiction, and Dogma, by Isaacs, Radovich, and Rothschild, respectively. This seems quite appropriate since I lay no claim to being a population dynamicist.

In the sense that every angler is an expert in fishery science, every hunter an expert in wildlife management, and every citizen an expert in politics, I will comment, expertly, on what is wrong with using catch-per-effort to solve fish population problems.

One of the greatest problems with fishery science is that concepts developed by certain population dynamicists get set in concrete. We tend to forget that a mathematical model of a fish population is something that you put on paper, on a blackboard, or in a computer, and is not a precise description of a real and complex biological phenomenon, no matter how hard we wish it to be. Biological phenomena are too difficult to model; too many variables affect them to even enumerate—let alone describe. I am not saying that models are not useful, but that their use can be a handicap if we forget what they really are.

Population models are built upon assumptions. We assume that the phenomena in which we are interested can be described by an equation; that variables, which are too many and too complicated to be understood, vary randomly and can be regarded as background noise; that certain factors are constants, even though in nature they may not be, because the solution of the problem requires that they be constants; and when we solve our problem on the blackboard or in a computer, we are surprised when the fishery, whose data we have used, behaves differently from our solution. Considering the complexities in nature, it probably should be more surprising if the fishery followed our model.

The real test of a model, of course, is how well it predicts, not whether or not we use biological sounding terms to describe its coefficients and exponents. If it doesn't work, something is wrong either with the mathematics, the assumptions, or the data. Population dynamicists usually blame the data, or occasionally the animal itself for not behaving in a predictable manner.

Let us take a hard look at some assumptions usually made in most fisheries calculations. I suppose that we can begin with Baranov who published his two famous papers in Moscow in 1916 and 1926.

He assumed in his model that fish are distributed evenly over the bottom of the fishing area, and that his unit of gear, a trawl, takes a constant proportion of fish within the swath of the trawl. The percentage of fish caught within the swath times the ratio of that swath to the total area is what he calls "elemental

fishing intensity". His "real elemental fishing intensity" represents a constant proportion of the fish population. This assumption, and others he made or inferred, such as uniform distribution of fish over the area, has persisted in the proliferation of fisheries' models. Since that time, there has been little attempt to confirm or test these assumptions, or even examine them closely. Many authors, such as Schaefer (1954), state the assumption that a unit of gear catches a constant proportion of the fishable population. Even though it is not stated, it is implicit in almost all fisheries models. This assumption implies three other assumptions which may not always be stated: (1) fish are distributed uniformly over the fishing area, (2) effort is distributed randomly over the fishing area, and (3) each unit of effort is independent.

Since none of these three assumptions are met in most fisheries, the assumption that a linear relationship exists between catch-per-effort and population size is usually incorrect. Most authors recognize that deviations from these assumptions exist, but generally regard such variations as random noise. However, there are many reasons for believing this is not so. It is my contention that *a given unit of fishing effort takes an increasingly larger proportion of the fish population as the population declines*. Another way of stating this is *the catchability coefficient is a variable which is negatively related to fish population size*. This, of course, is contrary to present use, which regards the catchability coefficient as a constant.

The rate at which efficiency of effort increases as the stock declines depends upon the nature of the specific fishery. This effect would be more pronounced in a fishery which depends more on hunting for fish which are contagiously distributed and on communication between fishermen, than in a fishery in which effort units are fished somewhat independently of each other on stocks which tend to be uniformly distributed over the fishing area.

The reasons for this are: (1) any usable unit of fishing effort such as a day's fishing, an hour's fishing, the set of a purse seine, length of a standard drag, etc. ultimately relates in some way to effort expended by man; (2) many species of fish tend to school up in certain areas more often than in others; and (3) effort units are not independent since fishermen tend to fish in areas where they had previously caught fish and they communicate with each other.

Let me give an example. When the sardine fishery began off the coast of California, the sardine population was very large, and fish were caught quickly, easily, and close to port. Catches tended to saturate gear, making it difficult to determine different population levels on the basis of catch-per-effort. Some

decline in the sardine population had to occur before any change in the catch-per-effort could be noticed. Of course, it is well recognized that, at high fish population concentrations, limited plant capacities result in boat limits which affect catch-per-effort, and adjustments can be made for this effort. However, common usage implies that below that level, catch-per-effort is linearly related to population size.

As the sardine population became smaller, it was obvious to fishermen that the fish were not distributed randomly over the fishing area. Schools tended to cluster, usually in certain areas more often than in others. Therefore, fishermen searched in a nonrandom manner. They searched where their experience revealed sardines were more apt to be found, and because sardine fishermen were capable of thinking and communicating with each other, they did not search independently. Each fishing boat operator was able to learn where fish were caught the previous night and increase his opportunity for success on a given night.

As the population declined further, the ship's radio became more important as did echo sounding equipment, both of which are less important at higher population levels when fish may be encountered shortly after leaving the harbor. Using radio, the entire fleet becomes alerted to where fish are being caught. This allows the fleet to converge on groups of schools so that fishermen can make better catches than if they fished independently and searched randomly for fish which were randomly distributed. In addition, mobility of effort in relation to the fishing area was great in the sardine fishery since boats delivered fish, which were caught from any part of the fishing area, to canneries each morning.

As fish became scarcer, dependence continually increased on communication, radio, and echo sounders. At low population levels, eventually airplanes were used to locate fish and even help fishermen set their nets around schools. All of these factors—communication, clustering of fish schools, intelligent and nonrandom behavior of fishermen, high mobility of effort in relation to the fishing area, and increased reliance on gear which aid communication and efficiency—tend to increase continuously the proportion of the fish population taken by a unit of gear as the population becomes smaller.

As the fish population increases, use of airplanes is discontinued and dependence on communication also decreases. Reliance on communication is a function of need which is related to the scarcity of fish. At higher population levels, communication becomes more of a social device than economic necessity.

Since the fisherman is interested in maximizing his profit, he does not expend his effort to randomly sample the population in order to find out where fish are scarce, as well as where they are abundant. Instead, he fishes in areas where his probability of success is the greatest. If we were starting out now to design a survey to determine the abundance of fish

off the coast, we would have a difficult time to design a more biased sampling scheme than one using catch-per-effort from the commercial fishery.

This bias, which is a result of the factors mentioned, should cause the catchability coefficient to increase continuously as the fish population declines. Therefore, if a fish population is overfished by too great an expenditure of effort, the catch should not come to an equilibrium at that effort level, as Schaefer's model predicts, but it should continue to decline until the fishery becomes commercially extinct, unless fishing effort is reduced. Furthermore, at each successive lower population level, effort would have to be reduced to a still lower level in order to start the population trend upward. The sardine fishery off the coast of California certainly appears to have behaved this way, and so does the Pacific mackerel fishery.

Richard H. Parrish (1974) has shown that the rate of exploitation of poor year-classes of Pacific mackerel off California is higher than that of strong year-classes. This is precisely what should be expected in a purse seine fishery with the characteristics of the Pacific mackerel fishery.

Schaaf and Huntsman (1972) say:

"Also we suspect that Menhaden are disproportionately more vulnerable when the population is small. While this hypothesis is unprovable with present data, the phenomenon could easily result from density-related behavior changes.

So for several reasons, despite an overall decrease in the number of effort units, fishing mortality has not decreased proportionately."

Bernard Skud of the International Pacific Halibut Commission (person. comm.) has indicated:

"Some of the Commission's earlier work also suggested a change in the relationship between CPUE and population size at lower stock densities, but the matter was not pursued very extensively. With our recent review of catch and effort data, we have been questioning some of the conclusions concerning halibut stocks and their management."

In a personal communication from John Gulland of the Food and Agriculture Organization, on this subject, he commented:

"We are not quite sure what the present situation in Peru is but there is a nasty feeling in the back of people's minds that although the catch per boat, catch per set, or other catch per nominal effort, has stayed put until very recently, there may have been a serious but concealed decline in the stock. I know, in fact, that some people are beginning to be very wary of using any catch per unit effort data in a purse seine fishery and are hoping to use something independent of the fishery such as acoustic surveys by research vessels."

New innovations which tend to increase efficiency usually are adopted over a period of time. These changes in a fishery are usually analyzed and catch

data are corrected. Once adopted, most of these innovations are considered to be fully in effect from then on, and all that is needed is a simple adjustment to the fishing effort. However, to the contrary, one should expect that improvements such as the radio and airplane would have the effect of increasing the rate that the efficiency of a unit of gear changes in relation to changes in fish abundance. In other words, efficiency of a unit of effort is negatively correlated with population size regardless of improvements, but the rate at which efficiency increases as the population declines would be affected by such improvements. This, of course, introduces another level of complexity into the problem.

Certain controlled entry fishery models are dependent on managing fisheries at the maximum equilibrium economic yield. They assume that the biological concept of equilibrium catch in relation to effort is valid—that the catch will come to some equilibrium at any expenditure of effort. Certain of these economic models also require a stability of effort expended from year to year, a feature which may make the successful management of the resource for maximum yield difficult.

So far, the discussion has referred to a hunting type of fishery in which fish schools and school groups are contagiously distributed, in which effort units are dependent on each other and on the success of previous effort units, and in which mobility of effort over the fishing area is high. In fisheries which cover a vast range, where an effort unit cannot reach more than a small part of the range in a day, the increase in efficiency of a unit of effort in a declining fish population would be less. The California-based tropical tuna fishery, for example, covers a very large range; boat trips last weeks, units of effort are spread out, and the effect of communication on efficiency is much less than in the sardine fishery. The advantage of fishing in specific areas where you found fish the previous trip also is less.

In a trawl fishery, where the unit of gear catches a percentage of what is in the swath, and where a catch-per-standard-drag can be related to some degree to the total area of the fishing ground, these effects may be even less. In this case, unless the fish tended to concentrate, the efficiency of effort on a declining population would not increase as dramatically as in a purse seine fishery. Nevertheless, these factors would still be in effect to some degree.

In some ways, it is unfortunate that most models have worked so well with the North Sea plaice fishery. This probably has deterred investigation of assumptions used in these models, and encouraged use of the assumptions in totally different fisheries, where they may lead to conclusions which are grossly in error.

The hypothesis that the catchability coefficient is a variable doesn't preclude use of catch-per-effort

data obtained from the commercial fishery, but it certainly casts doubt on the validity of some fish population models which assume it is a constant. A way of avoiding this major problem, as Gulland suggested, is to obtain return-per-effort data from a survey which is independent of the fishery—one which may be designed to sample throughout the fish distribution in some statistically valid manner. These data would be more scanty, and consequently more variable, but would not suffer from the bias inherent in catch-per-effort data obtained from the commercial fleet.

In discussing these ideas with population dynamicists, I find that in general they contend there is really nothing wrong with the models since an assumption of the model states that fishing mortality is proportional to what they call the "real fishing effort." They seem to be aware of these problems, but their publications rarely give a hint of such an awareness, and consequently "general practitioners" attempt to apply these models in situations where they cannot possibly fit.

Population dynamicists feel the problem with which we are faced is whether the units of fishing effort that we customarily use, such as number of nights fishing, number of purse-seine sets, and so forth, and which they call "nominal fishing effort", are a good measure of what they refer to as "true" or "real" fishing effort, or whether "nominal units of effort" become more efficient as the stock declines.

I am not saying this is a real "cop-out", but let us look at the population dynamicist's definitions: "real" or "true" fishing effort is that factor which he has on paper, the blackboard, or in the computer (at best, it should be called "theoretical effort"). On the other hand, the value you get from the fishery such as catch-per-days absence, catch-per-standard-drag, and catch-per-angler-day are not "true" or "real" but only "nominal effort." The inference here is that to the dynamicist, reality exists in the model and not in the world. This, I feel, is the crux of our problem.

There are a few other dogma that I would like to attack but these will have to await another meeting.

## REFERENCES

- Baranov, F. I. 1918. [On the question of the biological basis of fisheries.] Nauchnyi issledovatel'skii ikhtiologicheskii Institut, *Izvestiia*, 1(1): 81-128.
- . 1926. [On the question of the dynamics of the fishing industry] *Bull. Rybnovo Khoziaistva for 1925*, (8): 7-11.
- Parrish, Richard H. 1974. Exploitation and recruitment of Pacific mackerel, *Scomber japonicus*, in the Northeastern Pacific. *CALCOFI Repts.*, 17: 136-140.
- Schaaf, W. E., and G. R. Huntsman. 1972. Effects of Fishing on the Atlantic Menhaden Stock: 1955-1969. *Trans. Amer. Fish. Soc.*, 101 (2): 290-297.
- Schaefer, Milner B. 1954. Some aspects of the dynamics of populations important to the management of the commercial fisheries. *Inter. Amer. Trop. Tuna Commission. Bull.*: 1, (2): 27-56

## SOME IDEAS AND FRUSTRATIONS ABOUT FISHERY SCIENCE

JOHN D. ISAACS  
Scripps Institution of Oceanography  
La Jolla, California 92093

I am going to discuss a collection of ideas and some frustrations concerning fishery science.

I would like to sample a reservoir of ideas that I have collected over some years of association with fisheries science, and I intend to make a provocative presentation. Some of my contentions may be overstated, perhaps even unfairly, but I hope that they get the slings and arrows of outrageous fortune started—from which I will then stand aside. Nevertheless, I think the unfair ones and the overstated ones are not without substance, and I think that some of the points I bring up are downright serious indictments of fishery science.

I will begin with the assumption that there is a body of coherent knowledge that constitutes a field called fisheries science. I accept the existence of such a body of knowledge, but from then on I seriously question everything. As a matter of fact, all fields should be questioned and reexamined, in my way of thinking, and not questioned at the point where they now are but right down at their beginnings. The more I see the educational and research processes, the more I begin to liken them to some sort of austere anechoic halls, well plastered, where young people are led down along the asphalt tile corridors, some tiles inscribed with complex names or symbols, which must be remembered before proceeding. No one gets to tap on the wall early in these corridors to find if there is something hollow back of the plaster that needs examination. I think all fields suffer from this sort of "safe hall" where a leader can be followed to the final vista that he will eventually reveal. There is no chance to see if there are any vistas earlier. I like to rap on those walls and see if they genuinely show the limits of useful knowledge or whether they hide them, and whether they cover some windows and doors that have been closed long ago and which nobody has opened since.

If I might philosophize for a moment, this is the sort of thing to which I refer.

I live out in the country and I have a neighbor who periodically discs his field for some unknown reason—mainly to raise dust as far as I'm concerned. At any rate, I am interested to see how paths form across this newly disced field. They form very rapidly; our dogs going over to get handouts, the cats, the rabbits, the coyotes, the horses, and the people. There is an intergeneric agreement; all agree, after the first footprints, that this forming path is a very good place to walk and very rapidly they develop a beaten path. It is clear that the reason for this agreement is that something else had walked there and one is not as

likely to stumble or to fall into some sort of a trap as he would should he try to walk elsewhere. The more it is beaten and well trampled, the safer it is. I think that is a lot like the choices graduate students make and into which faculty lead them—well beaten paths.

At any rate, I would like to start with a serious questioning at the very beginning of these paths and, as I said, this is a sampling of a large reservoir. I have here a list of 14 questionable inherent assumptions in fishery science.

1. *Some steady state of biological, physical, or chemical conditions exist around which there is a normal distribution of perturbations.*

This certainly does not seem to be the case. The assumption is that there are some normal statistics to all kinds of conditions. Rather, there are probably a great number of possible regimes and abrupt discontinuities connecting them, flip-flops from one regime to another; multifarious regimes involving biology or climate, or oceanography, or migrations, temperature, or weather, or combinations of these. Probably one can illustrate this most succinctly by pointing out (which no one ever seems to point out) that the average temperature in Moscow is probably a negative 20°F, at least over the last 100,000 years, and its normal depth is under about 15,000 feet of ice. No treatment of present climatic statistics will even hint this, nor would a statistical study 50,000 years ago have predicted the present. This state is not a fluctuation around some sort of normal distribution, it is an episodic regime.

Ice ages are, of course, very conspicuous episodic regimes. On all time scales, it appears there are these locked-in persistent episodes in which it is either this way or that way or a third way or an *n*th way, and statistics have very little to do with the prediction except over very brief periods. Sardines, for example, are either here or not here. Rainfall follows these persistent trends, in periods of years during which it is high and others during which it is low. Thresholds may suddenly be exceeded, such as depletion of oxygen followed by mass death, whereas a speck more oxygen might have been above the threshold. One must consider these sorts of periods as quite different statistics. Recent changes in rainfall have fluctuated at one level in various parts of the world and then suddenly jumped up to some other level of fluctuation. The frequency of lightning storms in southern California, which occurred once every five years for the previous two decades, has increased about twenty-five times in the last decade. My main point



is that there are no simple statistics in the ordinary sense. There are internal, interactive episodes locked into persistence, and one is entirely fooled if one takes one of these short intervals of a decade or so and decides there is some sort of simple probability associated with it. I would like to return to this latter point because organisms must respond to more than just fluctuations around some optimum condition. Actually, many of their characteristics and fluctuations of populations must be related to these very large alternations of conditions.

Now in the very first step that must constitute fisheries science, the second cliché or inherent unexamined questionable hypothesis, or implicitly accepted assumption that I would like to examine is:

*2. Primary carbon fixation or oxygen evolution—the usual measurements of primary production—are valid measures of primary energy fixation.*

We assume that energy is well measured when we measure carbon uptake or oxygen evolution. Strangely, this implicit assumption has never been adequately checked. Bill Thomas and some others have made some tests of this—not under the extremes of conditions. It is not necessary for a plant always to take up carbon or to evolve oxygen to increase its energy resources. It can absorb photons elsewhere in the cycle of photosynthesis and add energy to the system through nonoxidative photophosphorolation. One thing that has always puzzled me when I consider the ocean is why the inhabitants of the very unproductive regimes are so energetic. One would think that they would be conservative, but the dolphin fish and the flying fish seem to be profligate with energy. It may be that there are energy rich and material poor environments where creatures are effective only when they expend a great deal of energy to capture what little material (and highly energetic material) that is available to them.

There are several examples of land plants upgrading energy in this way. For example, it has been shown that conifers in the north, during wintertime, are actually utilizing light—using it locally within the cells, not for photosynthesis because transport of material is not possible, but rather to increase their existing energy sources to make up metabolic loss and to make their materials more energetic. Thus, if one were to cover a winter conifer with a plastic blanket, and measure carbon and oxygen uptake and evolution, he will be quite wrong in estimating its energy uptake from light because the other routes have not been measured. This process has not been shown in the ocean, but it is difficult for me to conceive that plants in light-rich low-nutrient regions aren't capable of utilizing the luminous energy source by nonphotosynthetic processes, for these phytoplankters are even more sophisticated than other plant cells.

Another assumption is that

*3. Primary productivity is the principal organic input into most oceanic areas.*

I think that this may often be true. But it is clear that other inputs may often dominate, that input from primary productivity may be remote or delayed. These are the sorts of regimes that we see along the California coast, the downstream consumption of phytoplankton or zooplankton from energy elaborated well upstream; these are, of course, dominant influences in rivers and are examples of simple transport, where the primary production mainly becomes available at some distance, as in a grocery store. Other types and extents of transport and delays may also be important. There are apparently strong effects of a direct phytoplankton-to-detritus step in many parts of the sea, detritus which may be later remixed into the suspended particulate food. In Puget Sound, there is a secondary peak after the onset of winter storms from the remixing of dead phytoplankton on the bottom into the waters. We have never evaluated the direct phytoplankton-to-detrital step. A step resembling this seems to dominate the food chain of the Salton Sea. The most surprising results, I think, are John McGowan's recent results at the Equator. I have just glanced at his paper and was astonished to see that he finds the input of dissolved organic material into that region was about 500 g of carbon per m<sup>2</sup> per year. This is ten times local productivity and brings the total productivity, much of which would be unmeasured by ordinary methods, up to as high as that in the Peru Current. Perhaps this bears on the correlation of zooplankton biomass with nutrients, and the fact that that correlation is better than with productivity.

*4. Trophic food chains or webs exist with some substantial selectivity of food by particular species in some five or so rather well defined trophic levels.*

I have devoted some study or speculation to this matter, and what started me thinking (a number of you here have heard this before so I won't take much time) was the strange and most provocative results of Dave Young's thesis work of the uptake of cesium in the Salton Sea. Briefly, the Salton Sea has a more or less linear food chain, with food elaborated by phytoplankton taken up by zooplankton, but very little of the zooplankton is directly consumed. Rather, it becomes detritus, is fed on by worms, and then moves back up to the midwater food chain again. At any rate, in this almost linear food chain, from phytoplankton through zooplankton, worms, and up through several fishes to the top predator, corvina, the concentration of the element cesium increases something like a factor of three in each step, ending in the corvina with a concentration of about eighty times that of the phytoplankton. The concentration factors to corvina, through bairdiella, croaker, and sargo, each step involving an increase in concentration close to a factor of three, result in the

total increase in corvina. Nevertheless, in all these same several species of fish in the Gulf of California, the concentration of cesium over the phytoplankton is close to a factor of sixteen. One would have thought from the Salton Sea results that the concentration of cesium in each one of these steps was an index of their trophic position, and one might think, "Ah! I have a tool. I'll run and measure the cesium in the fish of the Gulf of California and elsewhere around the world and if the total concentration of cesium over that of the phytoplankton is 9 for this one, or 27 for that one, or 80 for another, I should discover where these creatures operate in the trophic chain." But one gets to the Gulf of California and the concentrations are all 16. So perhaps nothing like this happens in the Gulf of California or in the sea in general; all are eating out of the same trough. Perhaps oceanic food webs are so intermixed, with so much knitting and tating and crocheting, food and creatures moving from one place to another, gamete and detrital production, etc., that they are essentially homogenized. Trophic positions then become much simpler with only gross selections of food material being of significance, and with only herbivores, detrital feeders, predators, omnivores and a few others as meaningful trophic types. If so, it explains the factor of 16 and some other things that lead me to my next statement.

5. *The biomass of secondary consumers cannot exceed the biomass of herbivores in steady state.*

Another unexamined cliché, I believe, is that the biomass of secondary consumers cannot exceed the biomass of herbivores, and, correlatively, that the flux of food through the secondary consumers (that is, the predators, the detrital feeders, etc.) cannot exceed the flux of materials through the herbivores. This emerges from a food pyramid concept, and is the basis for believing that much larger fisheries can be supported by fishes low in the food web. This may be true in deep pelagic areas where detritus may be lost to the surface web. It is quite clear, however, that for a food chain in which everything is recycled a great number of times, where there are useful and recovered detritus and reproductive products produced in all steps, this limitation does not hold. In addition, to the degree that there is a direct phytoplankton-to-detrital step, any of these other forms can exceed the herbivorous step even further. I have just published on this subject in *Marine Biology*. It is a very simple concept. The total flux of material through herbivores over a chosen period of time (defined as the time required for the material to progress one trophic step in the web) and their biomass limit can be expressed merely by an input,  $M_o$ , multiplied by a coefficient that reflects the amount of food material that is converted into new living material. Equivalent expressions for detrital feeders and other secondary and tertiary forms can be derived by solving a doubly infinite series of terms,

expressing conversion ( $K_1$ ), irretrievable losses ( $K_2$ ), and retrievable losses ( $K_3$ ). This rather complicated way of going about things, however, reduces to very simple equations, such as:

$$M_m = M_1 K_1, \text{ biomass of herbivores}$$

$$M_d = M_o \frac{K_1 K_3}{K_2}, \text{ for detrital feeders}$$

$$\text{and } M_p = M_o \frac{(K_1)^2}{K_2}, \text{ for full predators.}$$

For coefficients well within the published ranges, consider:

$$K_1 = 0.4$$

$$K_3 = 0.3$$

$$K_2 = 0.3$$

The potential ratio of trophic forms in this noncompeting threesome is:

$$\frac{\text{full predators}}{\text{herbivores}} = \frac{K_1}{K_2} \text{ or } 4/3,$$

and that of:

$$\frac{\text{detrital feeders}}{\text{herbivores}} = \frac{K_3}{K_2} \text{ or } 1$$

Thus the sum of the biomasses of secondary consumers is  $2\frac{2}{3}$  times the biomass of the herbivore in steady state, for quite reasonable conversion coefficients.

Despite the simple nature of these equations, they may explain the persistent findings that there are larger biomasses of secondary consumers than there are of primary consumers, without invoking extremely rapid herbivore turnover rate or advection of herbivores or some other mystery.

An elaboration of this approach may allow us to envisage a way to quantify multispecies or "trophic level" interactions in fisheries, probably the single most important needed step in fisheries research and management.

6. *The only substantial aspect of gamete production is reproduction.*

I have been wondering about this for some time. Reproduction is a major metabolic loss from almost all organisms, and a loss of extremely high grade organic material. There are scars on scales, otoliths, and bones that mark the metabolic shock when gamete production or mating was taking place—severe growth discontinuities. In every species, if one can measure growth against age, one can see discontinuities of growth occurring at times of reproduction or even permanent changes at onset of maturity, and very severe changes, indeed. Even paedogenic larvae show such discontinuities. These are shocks to growth or even losses to somatic mass, and these are very large. Clearly, all this great production of reproductive products goes to primitive food. The survival

of gametes in terms of biomass is trivial—that is, the part of the initial egg material that is contained in juvenile tuna is infinitesimal. The reproductive products are consumed by filter feeders, by bacteria, by zooplankton, and in effect there here is a direct predatory step on the adult. One can interpret it no other way. Copepods do eat tuna! Mussels do eat yellowtail! There is undoubtedly a substantial or even dominate flow of material (and a larger flow of energy) downward in the food web through this mechanism, which must be a powerful part of the homogenizing process that I spoke of earlier. This mechanism is an aspect that we have the data to evaluate—Reuben Lasker's and other work—but we have not looked at it broadly in the ocean. Everything is sitting or swimming around throwing reproductive products freely into the ocean in such great quantities as to constitute a very powerful flux that is a predacious trophic step on the adult populations by primitive forms!

7. *Success of a recruitment is related to some optima biological and physical properties of the environment.*

The cliché here is that there is some relatively steady, physical, and biological optimum for a species and that the degree to which the conditions match these optima determines the success of recruitment. This is undoubtedly so in some culture experiments. I think that it has not been demonstrated in nature. Isn't it more likely that survival is always under suboptimal conditions—actual physical or chemical conditions—that suppress the competitors, or at least give the organism greater advantage over the competitors or predators, perhaps even at a life stage other than the adult one. I think this is seen very clearly in the terrestrial realm, where physical or chemical conditions are not optimum for most organisms but rather suboptimal and are ones in which the species has a relative advantage in respect to its predators, competitors, parasites, or pathogens.

I also think that we cannot even define optimal conditions of recruitment as related to any steady state, but rather fluctuating conditions may dominate the optima!

I was very much impressed by Mary Silver's defense on her research on salps, in which she demonstrated there was quite another kind of environmental interaction that could exist in the ocean—one resulting from time sequences rather than with conditions *per se*. Two species of salps seemed to be totally and exactly competing organisms enjoying the same water masses, the same conditions, and the same food, but they possessed an essential difference: one had a sexual resting stage and the other an asexual resting stage, and thus they responded differently to fluctuations in conditions. The one with an asexual resting stage could reproduce extremely rapidly in response to rapid onset or discovery of good conditions, whereas the species

with a sexual resting stage could respond only slowly but in far greater abundance and hence could dominate in slowly improving conditions. So it is the time rate of change of conditions under which it is determined which of these two species will dominate in any sequence. That is quite a different picture from sequences that are merely responses to some optimum condition. It is a picture that I think is not even very well recognized in the terrestrial realm except crudely, such as opportunistic populations following some episode such as a flood or a fire.

As you know, there are plants that have been waiting for just that sort of sudden transient event and take advantage of it. That is why you can buy a jar of fire-weed honey in the Northwest. This plant has jumped in following a fire after waiting for years in small enclaves such as where some fallen tree made space, and then opportunistically has taken over. I think that this is a much more common, continuous, and subtle mechanism of succession in the oceans. One can erect a theory of speciation and competition, defining a set of niches in time sequences of conditions.

I will go briefly into this. Garth Murphy has looked into some aspects of this matter, but I believe that he has not pursued it very far. Let's consider two exactly competing organisms, precisely competing in all ways, but with only two differences in life history. One becomes sexually mature at one time period, let's say a year, and has a longevity of 4 years; the other becomes sexually mature in 2 years and has a longevity of 8 years, not unlike the anchovy and sardine. One can easily see that with a straight probabilistic or episodic fluctuation of annual conditions (some 10 or so steps of good, intermediate, to bad years) precisely affecting both species in the same way, these two creatures will fluctuate together until some critical sequence is encountered, say 4 bad years. Now the two populations will change in their relative numbers according, not to the condition *per se*, but to the duration of these sequences. These two organisms then respond to all conditions precisely in the same way except when mediated through these critical differences in their life histories. Clearly, if there are 4 successive years that are bad for recruitment, the population of one is greatly reduced, but it requires 8 bad years in succession or some combination of that nature to equally reduce the second, but once bad conditions are over and there are some surviving remnants of the populations, the first species can respond to rapidly improving conditions and become dominant. It requires an unusual sequence to bring the second species to dominance once its population has been greatly reduced. So there can be fluctuations and, in a sense, environmental niches (perhaps even involved in speciation) that are not associated with conditions *per se*, but with the statistics or stochastics of time-rates of changes. I believe that models of this sort will be necessary to explain fluctuations and successions of creatures in the

oceans, and changes in their dominance. This seems particularly appropriate to the anchovy and sardine history. There probably is no such thing as a stable climax population.

8. *The nature of the relationships of recruitment to spawning stock in a single species is such that a specified fishing mortality can be accommodated, and that "maximum sustainable yield" or other yield estimates can be made.*

Without question, that statement constitutes the basis of management, and one of the principal efforts of fisheries science, and I think it is highly questionable. It is a mystery to me how we can look at fisheries as a single species model without examining its disabling defects and recognizing the necessity of developing multispecies models to emulate conditions. I would be hard put to accept as sane a farmer who would plant his crop without considering the number of weeds or employing a hoe or harrow to do something about them. I've been emphasizing the deficiency of single species models for a long time. I believe that it is the single most damaging cliché in fisheries science. The basic argument, of course, is that one is enabled to take some increment of the population because of the inverse relationship of year class recruitment and spawning stock, which putatively compensates for the fishing mortality. The plots of model are typical (Figure 1). You all know about this and we always hope we are operating on the starboard side which says, as the spawning stock is decreased by some increment, the year class recruitment increases by at least a compensating amount. Of course, it is not clear that we are free to take this increment, and I have always questioned whether that increment taken out really would otherwise have expended its life in vain or whether it would be fending off competitors, feeding predators, testing limits, widening the range, and/or doing other necessary things for the health and survival of the total population.

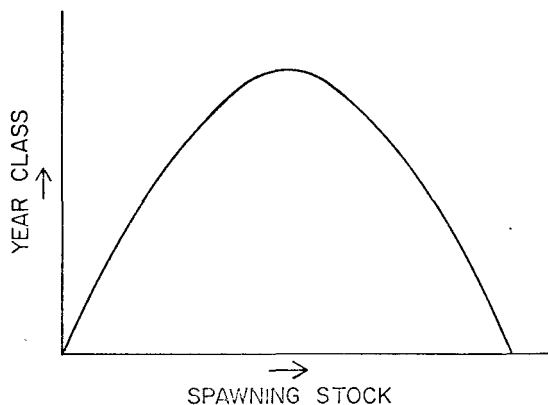

FIGURE 1. Typical model of year class recruitment and spawning stock relationship.

When we look at the data for the sardine during the years that it was here in abundance, points for the sardine fall very nicely in this sort of a relationship and appear to define the righthand branch of a classical curve (Figure 1). But later, when the sardine began to decrease, there was no appearance that it started to flip over on the left or dangerous side of the curve. Rather, it became a series of points seemingly defining parts of two smaller curves, in two steps. Surprisingly, when I took each one of the points on the sardine population and multiplied them by the appropriate ratio of the populations of sardines and anchovies, all of the points were brought into a simple line (Figure 2). Reconstructed, anchovies plus sardines fell on a curve, but not one species alone. I've never really understood why this wasn't clear *prima facie* evidence that a multispecies model is a necessity for understanding this, and that we must manage fisheries as multispecies or trophic level operations.

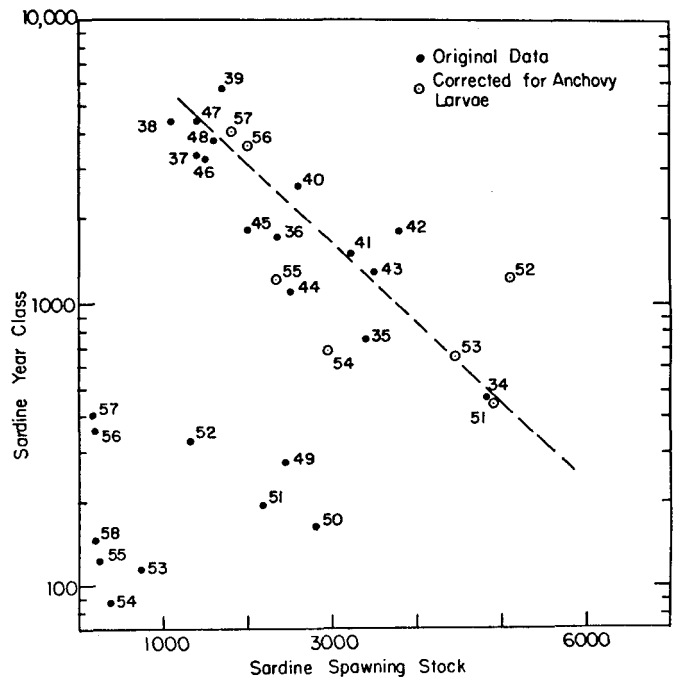

FIGURE 2. Sardine spawning stock and year class recruitment.

I am surprised how little we have considered the possibilities of a strong response of competitors when some population is fished. I believe that such responses are very real. For example, perhaps we stimulated the porpoise population by our heavy harvesting of yellowfin tuna and similar fish over the last several decades. It is conceivable that they are in symbiotic relationship, but they ostensibly are in direct competition, judging by behavior—porpoise feeding above and tuna feeding below on the same assemblage. If one looks at it this way, it is perhaps most inadvisable to spend our substance trying to understand how you get the yellowfin tuna out from

underneath this competitor without damaging it. If the yellowfin tuna could speak, I would think it might well say: "What do you stupid people think you are doing? We already are in an almost hopeless position with this profligate air breathing creature that takes all our food and now you are trying to figure out how you can take us from under them without hurting them. We'll be totally overwhelmed." Similar arguments could be made for the hake vs. silver salmon. Along this line, it may be that we want to be hauled kicking and screaming and agreeing to the Russians' taking all the damn hake they can possibly find, since they are clearly in close competition, at least with adults of silver salmon.

Last fall, while fishing in Barkley and Nootka Sounds on Vancouver Island, I was impressed by the organization of the salmon fishermen to avoid making sets where there are large numbers of dogfish. By radio, it is announced where salmon can be taken in the absence of these small sharks. At the same time, I find that trolling herring for salmon is no longer practiced, for any bait attracts dogfish. All of these small tactics are clearly effective in stimulating the dogfish population vis-à-vis the salmon. These tactics are no more than an exacerbation of every fisherman's efforts—from bent hook fishing to tuna purse seining—to conduct his methodology to maximize his catch of the preferred species, with an overall effect of maximizing the populations of undesirable species. Surely here is another example of maximization in the small constituting minimization in the large, and another example of the necessity for management at the multispecies level.

*9. The deep benthic populations are adjusted to a food source derived from a sparse rain of highly refractory terminal debris.*

Most of you have seen the photographs and motion pictures of the very active creatures of the deep ocean floor, clearly fed by windfalls of large pieces of higher class food. I didn't bring along the pictures of the great sharks in deep water off southern California, finally captured in three sequences of motion pictures. I consider them quite spectacular. The study of deep benthic populations has raised a number of mysteries—I'll mention one of them.

We find very many active fish attracted to the bait on the ocean floor under areas of very low surface productivity, and very few and inactive fish on the bottom attracted to our baits under areas of highest surface productivity, the first being the North Pacific gyre, the other being the Antarctic. One possible explanation of this is that in the very low productivity areas, the midwater population is so sparse that an occasional input of carcasses or fall of fragments completely overwhelms the capacity of the sparse midwater population, which is quite unable to cope with the fall and it continues to the bottom. However, in the regions of higher productivity, perhaps the midwater population has greater continuity and can per-

haps clean up material on the way down. Another possibility is that old or ill individuals of the large migrant species die when crossing the oceanic deserts. After all, land deserts are known for their vultures and jackals and skeletons! These situations are quite opposed to what one might have thought.

*10. The metal levels in marine organisms will reflect the levels of input and most of these levels will increase successively in higher trophic positions.*

With the interest in pollution, there has been a lot of talk about heavy metals and their uptake by marine organisms. One of the untested assumptions of this is that the metal levels in marine organisms will reflect the levels of input or concentrations and most of these will increase at higher trophic positions. I have already shown in a cesium example that they may not increase in the higher trophic positions. They might be all the same. Even more surprising is the Southern California Coastal Water Research Project finding that where benthic fishes are living on contaminated sediments, where some metals are 100 times what might be called normal concentration, of the 11 metals that they analyzed, all were lower in the livers of fishes living on highly contaminated sediments than they were in the same species at great distances. This is true except for perhaps one metal, iron, which is somewhat reduced in regions of high contamination and seems to be slightly increased in fish. This is a very surprising result. It is known that the fish were actually inhabiting these areas because their content of other contaminants such as DDT correlates very well with the levels in the sediments—so they are inhabiting those sediments in some sort of equilibrium. The metals, however, trend in precisely the opposed direction and with no relationship with what might be considered the trophic positions.

There are several possible explanations. For example, one that preserves the effect of contamination is that some unanalyzed metal may be concentrated in the fish. Then because of a general toxicity, the animal adjusts by generally excreting all metals in greater than normal quantities.

The explanation I suggest is that there is a great deal of food material in these regions. Most animals in nature are more or less starving to death. Perhaps the organisms in the regions of these contaminated sediments, because of the amount of organic material put in, are growing very rapidly, and the metals they do take up are essentially diluted by the new tissue. A relationship that has never been clearly pointed out is that, if one defines a concentration factor as the increase in some trace element in relationship to tissue in a single trophic step, the concentration factor cannot be greater than the reciprocal of the coefficient,  $K_1$ , that I defined earlier. That is because even if all the metal is absorbed, if the creature isn't losing any of it, it still has to be diluted by the material he is laying down in growth. So, the fast growing and

presumably efficiently growing organism will show a lower concentration than the slower growing organism, and this may be the reason for the lack of response to these metals. The metals are being diluted by growth. Victor Vidal is going to check this. There are some hot springs off Mexico that are putting forth elevated metal levels and obviously not making more food available unless they are killing local organisms. If the metals are presented along with no extra food, then the local organisms might show elevated metal levels.

*11. Plankton nets sample the population of fish larvae over some size range.*

Under this point, I get back to an old friend of mine. This is the plankton net sample of fish larvae over some size range. Some time ago, I proposed that plankton nets and larvae of anchovies and sardines were interrelated in such a way as to give one a larger and more important answer than just populations. They told you much more! They told you something about the growth rates, at least the rate at which the growth rates were changing in these larvae, and they told you something about mortality.

I proposed and put forth the data that the plankton net in regard to two species, the anchovy and sardine over a range of sizes, when hauled at night did in-

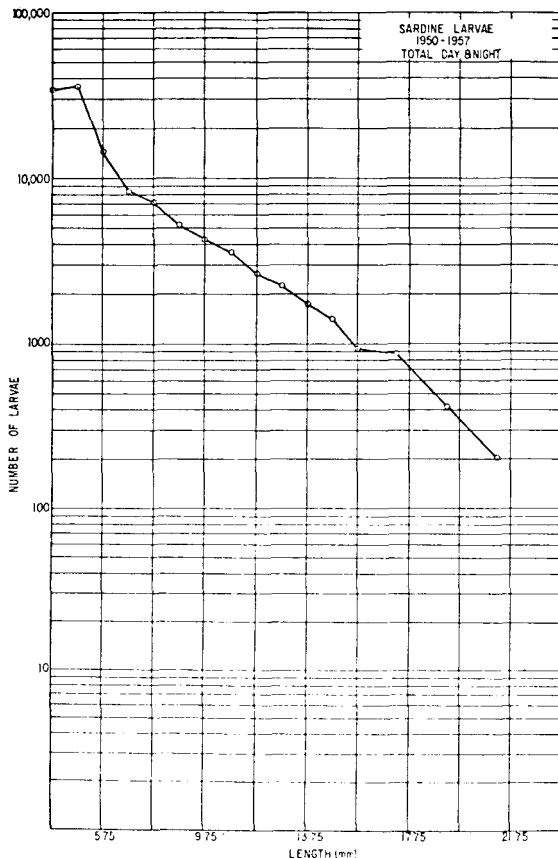

FIGURE 3. Size frequency for total day and night caught sardine larvae, 1950-1957.

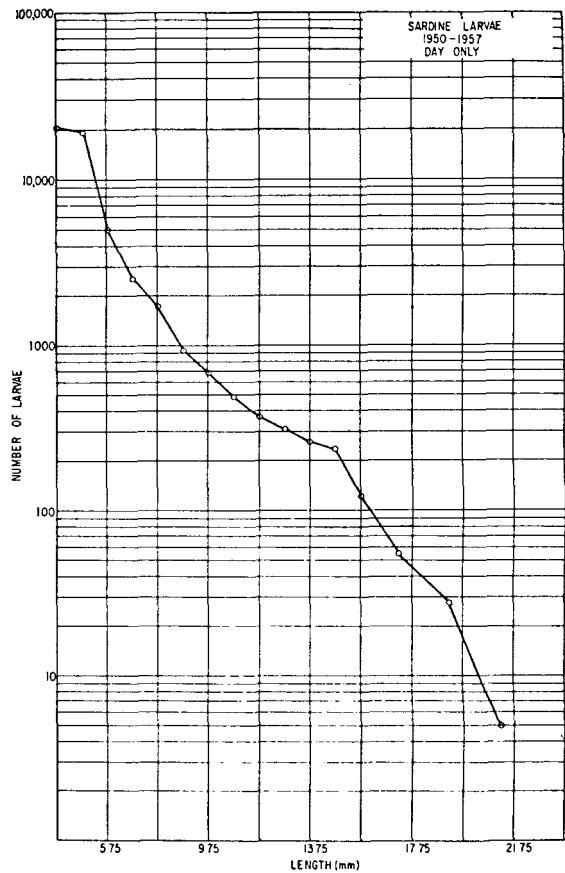

FIGURE 4. Size frequency for day caught sardine larvae, 1950-1957.

deed sample the population, but when hauled in the daytime, it sampled a portion of the population that was a measure of the portion that was going to pass on! In other words, the day catch was some measure of mortality. These data seem to be as strange as some of the data in atomic physics, and one either has to accept them or explain them away.

The plankton net hauled during the day, samples a portion of the population that is equal to the proportion dying! If this is really true, it is a very powerful entrée. We have two powerful pieces of data: relative growth rates and relative mortality between years among different species. Yet, I must say, I put this paper out and thought that I would receive some real criticism. But it disappeared into what I have been calling the anechoic chamber of fisheries science! I've never had anyone say: "You are all screwed up, for this reason or that reason" or "Gee! What a great idea, I see that you are correct, obviously you are correct and now let us incorporate it as a vital tool in fisheries science!" I got neither, and I really don't understand why either I didn't get hit over the head or somebody didn't take this and use it. Since I have you captive and have only two more points to make, I'll spend just a moment showing again how this works (as I have shown in both Science and CalCOFI Reports).

This is the typical size frequency diagram for sardine larvae (Figure 3). There seems to be very little relationship between the slope of this curve, which you might interpret as mortality, and the measured survival of year classes. However, if one breaks these size frequency diagrams into catches during the day and catches during the night and normalizes them for the numbers of such catches, there are two surprising transformations.

The day catch is even steeper (Figure 4). The feature that took me 6 years of self-persuasion was that the day curves are the first derivative of the night curves—a very strange result, and when the decrease in the night curve across an interval is compared to the related total catch during the daytime, there is an absolute 1:1 correlation (Figure 5). In other words, the day catch is the missing part of the population as measured by the night curve. So in some strange way, the daytime curve is measuring the mortal fraction, and it is not that it merely has been subtracted from the totals.

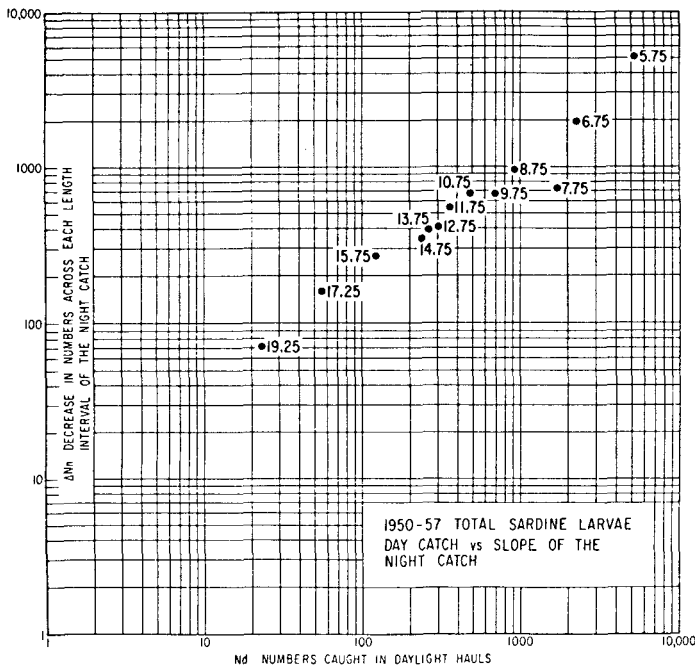

FIGURE 5. Total sardine larvae day catch vs slope of night catch, 1950-1957.

Let me show you something else more astonishing (Figure 6). The other test is to sum up all these intervals of daytime catch and add them successively to the night catch. This reconstructs a nonmortal population! The only possible explanation of this is that the mechanism of mortality, not the cause of mortality, is some sort of a predator which the net quantitative models in day catches. One can show that the larvae caught in the day are active, so they are not dying, only they are representative of those that will die. Perhaps they are merely disoriented, less physically alert, or starving, or they may be solitary larvae, as E. H. Ahlstrom suggested one time.

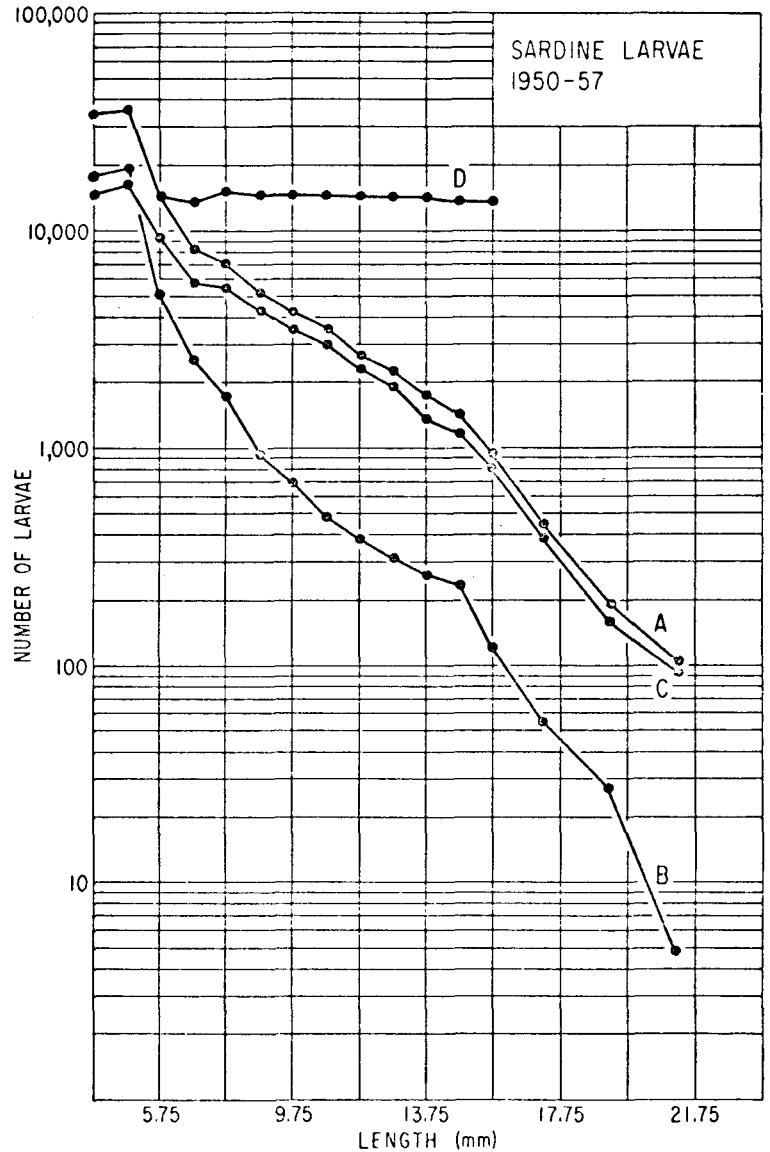

FIGURE 6. Sardine larvae numbers vs length. Curve A is the total catch; Curve B are those larvae taken in daytime hauls; Curve C are those taken in nighttime hauls; and Curve D is a successive summation of the day curve added to each value of the night curve (this should reconstitute the population as it would be sampled in the absence of mortality).

Another fact, curve D (Figure 6) of the reconstituted nonmortal population for different years, either ascends slightly or descends slightly or is level. If the rest of this is true, then the only explanation for a slope of the reconstituted population is that growth rates are changing with length and hence the length of time that larvae spend in these length intervals has changed.

If one interprets these slopes as relative growth rates, and compares the anchovy and the sardine using the graph of relative growth rates (Figure 7), the years 1956 and 1952, the only 2 years advantageous to the sardine, are clearly separated, all the rest being advantageous to the anchovy. If one also plots these relative growth rates as defined by the

slope of the nonmortal curve against recruitment, all points fall on line (Figure 8). One of these days, I would like to hear someone say on this entire thesis that I presented so long ago: "You are absolutely nuts, this is an artifact of the way you handled the data" or "Gee! This is great; let's get at it. This is the way to determine what the success of a year class is going to be, by looking at these larval analyses." But

I have shot this around into the anechoic field of fisheries science, and there apparently is no way to tell if it is alive or a dud. I plan to fuss more about some of these theses. I'm getting too old to wait any longer.

12. *The stocks of fish can be appraised only through sampling of the fish at some stage (including eggs) by direct catch (including tagging studies), acoustics, or other "counting" methods.*

This I think is important, but I am not going to spend much time on it.

First, I think there are some other things to do in acoustics. If we examine very low frequency sound, a fish is an absolutely unique object—a soft place in the water if it has a swim bladder. It alters a great region of the water and the properties there are more profoundly changed. In the case of high frequency, all that the presence of a fish school does is give a reflection, but at low frequency, sound is moving at half its normal speed within the school. This is a very profound effect that isn't true in bulk for high frequency sound. Thus if we transmit sound of very low frequency through a region of fish schools (fish with swim bladders), the transmission of some of the signal would be uniquely and strongly retarded, perhaps quantitatively!

Another important method is one where estimates of populations of pelagic fish are made using fish scales in the sediments of varved cores in the Santa Barbara and Soledad basins. These records very closely follow the present known history of the sardine and anchovy, the build-up of the anchovy and the fall-off of the sardine numerically, and independently of the fisheries data.

The point is, if we can do that much with fish populations in the sediments in these limited areas, what could we do if we actually put down sedimentation collectors? There are only a few places where these sediments are naturally preserved, only two along this coast. But if we were to put down collectors, on a grid and properly deployed above the ocean bottom, we could very closely estimate not only fish populations (an inescapable conclusion), but also what water masses have been present, what phytoplankton, and most particularly, what shifts in climatology of the California Current have occurred. Since in a very readable way, one can relate back into the remote past (as part of this statistical or episodic type of distribution we have been discussing) back for the last 2000 years, why can't we do it at present?

13. *Enforced primitivism in fishery methods is a viable management strategy.*

An incredible anachronism is the way in which we conduct our fisheries. I was astonished to see the huge progress in Washington and British Columbia in the trolling fishery since I fished in those latitudes. They now all carry radar and radar targets to keep

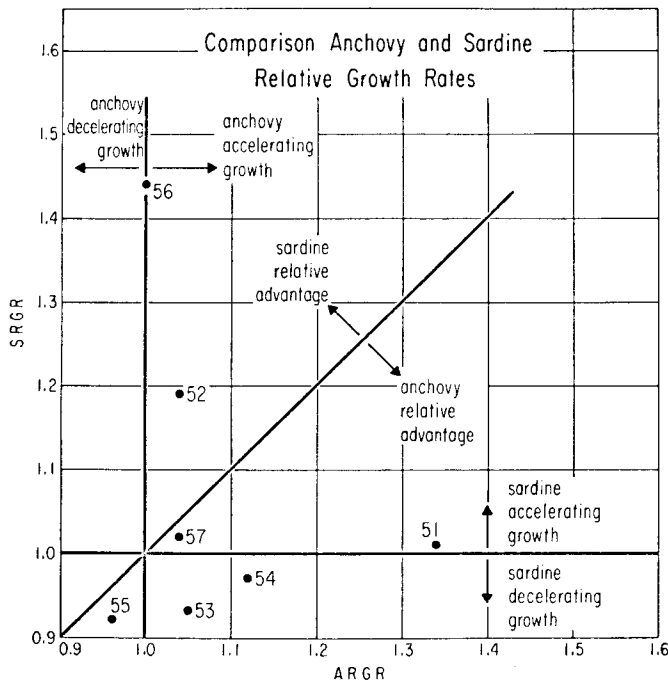

FIGURE 7. Comparison of anchovy and sardine relative growth rates.

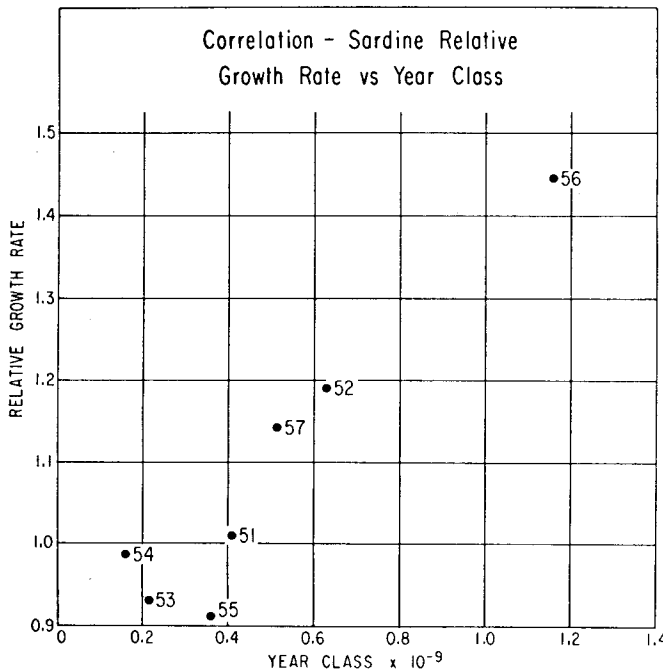

FIGURE 8. Sardine relative growth rate in relation to year class.



from getting run down by the Japanese and Russian mother ships. That's the big technical advance in the last 40 years. Otherwise, it's still little men pulling nets and little men pulling trolling lines in the midst of this particular highly technical society. We are the only nation in the world that insisted up to recently that a great fishery be conducted by such inadequate craft that the boats were built with handles on the bottom to hold on to when these miserable things capsized.

How in the world do we manage this? One hundred years ago, the advanced technology of taking all the allowable catch salmon off these great rivers of the North was well known: fish wheels and traps. These fishermen now could be partners in an industry carefully managed for the take of salmon. They've been outlawed. In attempting to improve their lot, we fiddle around making better corks or cords for these nets so that the fishermen can sit out in the middle of the harbors and dodge the Japanese ships. Only those fisheries, such as the tuna fishery, that have largely escaped regulations have been successful.

14. *Lack of scientific understanding limits the development of some important existing or potential fisheries.*

That is true. We have developed part of an anchovy fishery, now limited by social misunderstanding; but I will submit that reasonably successful fisheries seem to be the ones that little is known about (menhaden, king crab, tuna, etc.), and the least successful fisheries, the ones most is known about (anchovy, hake, and halibut).

Well this is a short list out of a big inventory. I think we have to have serious study not only of the few indictments by one person who is only somewhat peripherally associated with fisheries research, but a full panoply—the total inventory must be immense—it makes me shudder to think of it. I think we should have a series of colloquia, perhaps a summer study, truly to evaluate and get down to brass tacks on these clichés, these dogmas, these facts and fictions in fisheries science, and perhaps elicit some echoes from the silent halls of this field.

# FISHERY SCIENCE: FACT, FICTION, AND DOGMA

BRIAN J. ROTHSCHILD  
National Marine Fisheries Service  
La Jolla, California 92038

In response to the symposium theme, I shall discuss fishery science in the context of fact, fiction, and dogma. The fact will be a definition of fishery science. The dogma will set forth the corrective actions that will be required if, in fact, our assertion that dynamic progress in fishery science is a fiction is correct.

## *The Fact*

A fishery involves the extraction of fish from their habitat. This extraction is a socio-economic process with biological constraints. The study of this process, then, cannot simply involve isolated studies of biology, economics, or sociology. The study must involve an integrated examination of all of these. It is clear that such an integrated examination is necessary to provide the analysis required for better fishery decisions and it is further clear that owing to contemporary increased resource use, we have a greater responsibility to focus our talents on these issues and indeed make dynamic progress in fishery science.

## *The Fiction*

If our notion that dynamic progress in fishery science is a fiction is correct, then, we must be making dynamic progress in:

- Developing the bio-socio-economic strategies of fisheries.
- Dealing with overfishing and the root causes of overfishing.
- Modifying the institutions that nurture open access and unlimited entry into the fisheries.
- Materially increasing our understanding of the most fundamental of biological fishery problems —the problem of stock and recruitment.
- Understanding the costs and benefits associated with pollution as it relates to the fisheries.
- Developing the bio-socio-economic theory of multiple species fishing (for example, if we can catch 10 tons of species A and 20 tons of species B, can we, in general, catch 30 tons of species A and B?).
- Stimulating the fisheries community, scientists, industry, and administrators, to participate in rational management and actually to be held accountable for fishery mismanagement or irrelevant or low quality research.
- Understanding of ocean-fish interaction. There has been very little marginal increment in our understanding of ocean-fish interactions over the past few decades. Although there are many correlations between the abundance and distribution of fish and some index of what is happening in the ocean, these correlations seldom hold

over a period of time in the future. This indicates the lack of a fundamental understanding of the cause and effect relations between the fish and the oceans. Without this fundamental understanding we will never be able to make successful predictions based on measuring ocean variables.

- Developing biological and economic theory that deals with short term fluctuations in abundance (Nearly all population dynamics models are long term, equilibrium, or “on the average models.” We need to predict what is going to happen next year and this cannot be efficiently obtained from long term averages. Again, we have to examine cause and effect mechanisms and develop a body of knowledge that deals with short range events. At the outset this will require a probabilistic approach rather than a deterministic approach).
- Developing information systems which deal with storage and retrieval of fisheries and ocean information (There are many highly sophisticated and efficient methods of dealing with information; in fisheries we have barely scratched the surface in utilizing these new methods).
- Developing algorithms for allocation of fisheries stocks in the time-stream. We need to replace maximum sustainable yield which is not, among other things, an economically-sensible fisheries criterion. For example, MSY is a theory that suggests a constant catch every year which does not respond to changes in price. A constant yield every year cannot, in general, have any built-in discount factor.

## *Dogma*

If we agree that dynamic progress in fisheries is a fiction, then it would seem appropriate, according to the theme of this symposium, to formulate a dogma that will make our progress dynamic. I believe this will involve:

1. Modification of existing institutions and creation of new ones that can explicitly focus their resources on the bio-socio-economic fishery problem. I am not convinced that we have institutions that are presently capable of focusing on fishery resource problems in a way that is compatible with the acceleration of the complication of our decision problems in the fishery area.
2. Recognition that we have only a finite amount of time and budget in an environment of accelerating decision complexity. We cannot work on all problems; we need to examine our objectives and alterna-

tive ways of achieving these objectives more carefully. Most important, perhaps, we should look at the criteria by which we select these alternatives. This is not only a problem which applies to fishery organizations, but to individuals as well. Each individual has a finite amount of time. Given a climate of increased social responsibility, we need to judge how best to allocate our time and financial resources to making better resource decisions.

3. We need to recognize that it is no longer sufficient for a responsible scientist to provide simply a shopping list of problems. The responsible fishery scientist, in addition to providing a list of problems, must also indicate which of these problems is most important. We must ask, "Why are we doing what we do?"

4. We need to allocate much greater effort toward investigating cause and effect mechanisms and much less effort toward developing correlations. The limited success in fishery oceanography and stock and recruitment studies results from a heavy reliance on a correlational approach.

5. We need to challenge the assumption that universities are providing people with the skills and background to cope with contemporaneous fishing resource problems. We have a new set of questions today and I think we have to ask our universities whether they are providing graduates with the skills needed to handle these problems.

6. This will involve the direct development of new techniques as well as the application of techniques

already existent in other fields but not used in fisheries. For example, most of the mathematics used in fisheries rely almost totally on applied statistics and calculus. Indeed we have had substantive contributions to our knowledge from the application of statistics and calculus to fisheries problems. Unfortunately, statistics and calculus are not (with a few minor exceptions) helpful in answering the most critical fisheries question: "Who gets what?" How do we allocate resources in space and time to harvesters and processors? The general class of problem is also important from a biological point of view. To take one example, "How are prey allocated among the predators? What objective function do predators have?" There is a body of mathematical techniques that is applicable to these problems. It is called mathematical programming. It is curious that such powerful mathematical techniques for the study of allocation have not really been applied in the area of fisheries or aquatic sciences, and yet the application of these techniques may give us new and broad insight into these critical questions. This is, of course, but one example of available methods which could be applied to help us make our progress in fisheries more dynamic.

In conclusion, I have given my view of the fact, fiction, and dogma of fishery science. I do not think that our progress is totally fictional; on the other hand there are significant and material planning actions that have to be undertaken if we are to adequately face our responsibilities as we accelerate our progress toward making fishery decisions in an environment of increasing complexity.

## FISHERY SCIENCE: FACT, FICTION, AND DOGMA PANEL DISCUSSION

*Frey:* Gentlemen, are there any additional thoughts concerning fishery science: Fact, Fiction, and Dogma?

*Isaacs:* Brian, in your particular shopping list problem, I didn't hear you express your priorities, or did you do what I did, assume your whole list a set of number one priorities and sent it by freight?

*Rothschild:* You are right, I did not indicate any priority mainly because I thought all these were number one. The second reason is that it is a very bad thing nowadays to think in priorities. The reason is illustrated by the story I frequently tell about the shopping list that has a cadillac, a beef roast, and shoe laces, and you ask anybody what their priority is and to rank them in that order. When I say, "Oops! you only have a budget of \$27," the beef roast suddenly becomes number one, shoe laces number 2, and the cadillac number three. The answer is, if you tell me how much money you have I can give you my priorities.

*Frey:* Question regarding fishery allocations. Do you think this is the fishery scientist's job or do you feel this is a decision that should be left to politicians?

*Rothschild:* That is a real good question. It is a decision that should be left to politicians. However, the problem is that one reason we may not have been making as good decisions as we might is because politicians frequently make their decisions on more or less ad hoc kinds of information. It is the job of the scientist to present to the politician a menu of alternatives, and to provide for the people who make the decisions the consequences of the kinds of decisions they make. I think we can see this in nuclear power plant siting. I think it is the job of the scientist to present the new alternatives and the consequences.

*Isaacs:* Take one case, one I already referred to, excluding the porpoise from the catch. The scientists were not presented any freedom of alternatives. The politicians presented the scientists with a task and as far as I can find out, the scientists didn't even start to

consider the significance or the alternatives, only how do you do what the politician asked them to do. True?

*Rothschild:* No I don't think it is.

*Isaacs:* Oh! The politician was presented with a list of possibilities.

*Rothschild:* No, I don't think the politician was presented with a list of possibilities at the outset, but I think this is certainly happening now.

*Isaacs:* I have always maintained that a rational view of the universe must include irrationality, as far as this universe is concerned, anyway.

*Rothschild:* I think it was Seneca who said, "In every genius there is a touch of madness," which is my way of saying the same thing.

*Radovich:* I would like to comment on one thing; John Isaacs' point in discussing the relationship of recruitment to spawning stock. John said a good relationship existed between sardine stock and recruitment, with a downward trend, but the points on the graph were widely scattered. If you look at the data more closely, rather than scattered, it appears as two other regimes. This can be interpreted in different ways. John interpreted the scatter as the effect of an anchovy population on the sardine population. By adding in the anchovy, he considers the total biomass as one population. Another interpretation of the three regimes is that more than one stock of sardines existed on the coast. If you had a far northern stock, off British Columbia, Washington, and Oregon, the curve would represent the total population being fished. Sardines were fished in the summer off British Columbia. Later in the fall, the same fish were caught in California. The northern populations were more vulnerable and disappeared first. As the northern populations disappeared, the curve dropped to lower regimes.

*Isaacs:* John, I think you are right, and it is the mechanism of my main point, which was that it's explicable on merely a shrinking lebensraum for the creature, not from changing conditions or entirely from the fishery but from the encroachment of the competitors. From the actual data it appears that there were three episodes of shrinking space for the sardines.

*Radovich:* Yes, so it appears as if you have three regimes. If the northern population declines, and if the middle one also disappears, you are left with the lowest curve. It seems to me you can explain the graph on that basis.

Another point concerning adding anchovy data is that earlier anchovy data, which is extremely scarce, gives two different interpretations on the size of the anchovy population. One interpretation, as John Isaacs indicated, is that if you added the anchovy population to that of the sardine, the total biomass would be higher and respond as a single population. Another interpretation is that there weren't that many anchovies around at a time when sardine population was low, and adding anchovies didn't give

that picture at all. This was Paul Smith's interpretation, if I am not mistaken. The data are sufficiently scanty that you can do with them what you wish, and that is unfortunate.

*Isaacs:* John, I did spend some time correcting these data and they were restricted to very short-length intervals that I considered were properly sampled, for reasons that I could go into *ad nauseum*. These data are the estimates of sardine populations multiplied by the ratio of sardine/anchovy larvae plus unity (I'm using the larvae as a proportional correction) as the best estimates of adult stock. You are quite correct, it looks like two other regimes in respect to the sardine, a total of three—but for the total, only one! One might still consider at any point in one regime that the population is in a good position, and yet they actually are disappearing, not that they don't have the proper statistics within the regime, but because there is another species that is crowding their living ground.

*Rothschild:* I jotted down some notes as you were talking.

John Isaacs, I think you have raised some good points on the catch-per-unit-of-effort problem. I wanted to emphasize a few of them. My first point is that the problem of deviation from models is an indication that models perhaps are not quite what they might be.

I think this is probably not the most important function of models, but the most important function of models is to generate questions. If you have a model, it means you are modeling through a problem rather than muddling through a problem and you can therefore ask questions, "Why have I gone wrong?"

The second point is that I think to some extent you deprecated the use of the computer, and I share your deprecation in a lot of instances. I think one of the reasons they have gone bad is because in many instances we have used computers for what people do well, and then turning around we have used people for what computers do well. This is a very important phenomenon that has caused considerable problems with computers.

*Isaacs:* I am really concerned, not just from a standpoint of fisheries, but this kind of Word-of-God effect that computers seem to pour out. Talking about meteorologists, if you will notice since computers came in meteorological forecasts seem to be rather poor. The reason for that is the well experienced seat of the pants type meteorologist has no input. He says this forecast is idiotic but he has no way to argue with this Word-of-God the computer is putting out. So I think it is a neo-theological effect that you are dealing with here and arguing about, rather than the inherent capacity of the device.

*Rothschild:* Precisely.

*Radovich:* Let me comment too, while we are on this. I did not mean to imply in any way that models are not useful. I thought I made that clear. What I

said was, if we forget what models really are and use them as what John Isaacs has called a "new developing theology", then we are in trouble, but as long as we use them as a tool and a guide and remember that we are solving something on paper, then it's OK. I think there has been a tendency to go the other way.

*Rothschild:* That's a good point and I agree with it.

My third point, you finished up on what population dynamicists really say about catch-per-effort and I agree with it. My only thought is that I wonder if we are thinking about the concept in terms of catch-per-unit-of-fishing-mortality rather than catch-per-unit-of-nominal-fishing-effort; whether or not the same criticisms that you generated would be applied. The second thing is the whole question of catchability, and there are at least two studies that I know of offhand in which catchability does vary as a function of population size. One is the study on king crabs that we did in Alaska that had very clear indications of catchability varying as a function of population size, and the other is a paper that just came out. It was an ICNAP presentation by David Garad that showed, I think in the cod fisheries in the Bering Sea, a very clear relation between catchability and population size. At high population size, the catchability was lower than at low population size. The next is age structure—models independent of catch-per-unit-of-effort. There is a series of models that work independent of effort, one is back calculating, we call it the Murphy method, but those who know John Gulland know it is the John Gulland method because he put it out at the same time.

Those that really know the literature know it is the Ricker method because he put it out 10 years before either of them, and I call it the iterative solution of the catch equation, and incidentally this solution does put out catchability as a function of age, size, and many other things, so it needn't be constant.

Other methodology is in tagging models which are probabilistic models for estimating a whole variety of rates and using this methodology you can estimate effort independently of catch-per-unit-of-effort.

I hate to mention something as old as the virtual population estimators which do have problems with bias, but I suppose you could measure real effort from these independent of nominal effort.

My fourth point is with respect to the fisheries independent methodology ranging anywhere from space craft to someone standing in a salmon stream counting the fish as they go between their legs. I think we have to look at the question of cost.

Finally, with respect to the menhaden example, the fish became concentrated and as a result of this they became much more vulnerable. What happened to the anchovetas off Peru? The water got warm and the concentration of the anchovetas increased. Catch-per-effort went up without abundance going up.

*Isaacs:* May I ask a question there? I've puzzled about these concentrations. One possible explana-

tion is their preferred feeding mode is feeding on some sort of zooplankton schools of one sort or another—herring do.

*Rothschild:* I'm not sure anchoveta feed on zooplankton.

*Isaacs:* As the population goes down there are more available to them, these accumulations of food, in which they then go into schooling mode of particulate feeding more than a more dispersed mode for filtering. Whether it is true or not, an interesting question about the food of these fishes is: "Do the stomach contents of specimens that are caught in usual fishing represent the usual food materials?" It is quite possible to be misled as to normal feeding habits because one looks at only specimens taken only in a special feeding mode when they school or otherwise behave differently.

*Rothschild:* That is quite right, I keep thinking anchovetas feed on phytoplankton more than zooplankton.

*Isaacs:* They do feed mainly on phytoplankton, but these also may be spotty. When the fish are numerous perhaps they don't have these accumulations that they school around as commonly.

*Rothschild:* I wanted to mention on the troll fisheries in England, this question of density versus catch-per-unit-of-effort was pretty well demonstrated in parts of the 1963 symposium on the measurement of abundance of fish stocks (Cons. Explor. de la Mer., 155:1-223).

Now may I comment on some remarks by John Isaacs. I thought that these questions that John raised were quite valid—Questionable Inherent Assumptions in Fisheries Science. I have to express some disappointment that John is in an antichoice chamber and somehow we aren't attacking these questions better. I would say, a lot of people are thinking of these questions—people I know are thinking of some of them, and I would comment on the first one with respect to the normal distribution of perturbations. This gets into what you mean by probability. On the one hand I think that one could argue that just about everything is normally distributed if it's an average, by the central limit theorem. On the other hand, there are distributions that have no finite mean and variance, such as cauchy distribution. Maybe that is what our plankton distributions are drawn from, they very well could be and in that case it makes little value to work on them.

The second thing that has concerned me about primary productivity and its relation to fisheries, since this colloquium is oriented toward fisheries, is the measurement of the noise between plankton and fish. In other words, how variable do the plankton have to be to make them observable in what the fish do?

I was particularly interested, John, in your comment about exactly competing organisms with slightly different life histories because this is what happens within a species. We have almost exactly competing

organisms with slightly different life histories and I think this is what evolution is all about, is how certain of the genetic potential is carried forth.

*Isaacs:* Fisheries develop subraces of salmon—the clearest case.

*Rothschild:* Right—and my ultimate point is your comment about regulation and management strategy, all of which I pretty much agree with, but when you say that the only fisheries that have problems are the ones that are regulated, it reminds me (Isaacs actually said “Only those fisheries that have escaped regulations have been successful.”).

*Isaacs:* Is that what I said?

*Rothschild:* I hope it's not a spurious correlation—my last remark was that I think a lot of the things we

have been talking about illustrate what is wrong with our present models, and I think this focuses in some priority sense that we have to come up with better models which aren't necessarily mathematical but simply an arrangement of concepts that leads us to asking new questions.

*Isaacs:* Of course, the most valuable model is pragmatic—the world is an imperical object, it has multiple interactions of all kinds of entities all interacting precisely the way that they do in this world without any college education whatsoever or any computer or anything that a computer can now foresee or that it can handle. A study of the past, as I pointed out, the sediments, makes the best model you can erect, a truly pragmatic model.

*Frey:* Thank you gentlemen, we are out of time.

## **B. OCEANOGRAPHY AND FISHERIES OF BAJA CALIFORNIA WATERS.**





# HIDROLOGÍA DEL ALTO GOLFO DE CALIFORNIA—I. CONDICIONES DURANTE OTOÑO

SAÚL ALVAREZ BORREGO

y

LUIS ARNULFO GALINDO BECT

Unidad de Ciencias Marinas  
Universidad Autónoma de Baja California  
Ensenada, Baja California

## ABSTRACT

Some preliminary results from the October and December (1972) cruises are presented. Even though we do not have the information from a complete year cycle, we have deduced some conclusions. The surface temperature and salinity distributions for the two cruises indicate that the net circulation, without considering tides, is counterclockwise. Some characteristics of the distribution of the suspended sediments shown by space photographs taken by the ERTS-I satellite, support this. This solves the discrepancy presented by Thompson (1969) in favor of the counterclockwise circulation. According to this, the pollutants of any type that come from the Colorado river delta zone, carried by the river waters, would affect much more intensively the portion of the upper northern gulf near the Baja California coast than the portion near the Sonora coast; and the pollutants coming from remote sources (i.e.: the central Gulf of California) carried by marine currents, would affect the portion near the Sonora coast more than that near the Baja California coast. Comparing the dissolved oxygen surface distribution for October with that of December, we can deduce that the pollutants carried by the Colorado river, such as pesticides concentrated in planktonic organisms and suspended organic matter, and those absorbed in suspended sediments, are incorporated to the marine environment in a fashion as irregular as the fluvial regime of this zone. This indicates that any quantification of the pollutant income from river streams to the upper northern gulf, can only be presented in terms of total quantities per year and not in terms of a continuous flux.

## RESUMEN

En este informe preliminar se presentan algunos resultados de los cruceros de octubre y diciembre de 1972 en el alto Golfo de California. Aún cuando no se cuenta todavía con la información de un ciclo anual completo se han deducido algunas conclusiones. La distribución superficial de temperatura y salinidad para los dos cruceros indica que la circulación neta, sin considerar el flujo y reflujos de las mareas, es rotatoria en el sentido contrario a las manecillas del reloj. Algunas características en la distribución de sedimentos en suspensión, mostradas por fotografías espaciales tomadas por el satélite ERTS-I, apoyan lo anterior. Esto resuelve la discrepancia presentada

por Thompson (1969) a favor de la circulación rotatoria en el sentido contrario a las manecillas del reloj. De acuerdo con lo anterior, los contaminantes de cualquier tipo, que provengan de la zona del delta del Río Colorado, acarreados por las aguas del río, afectarán con mucha más intensidad a la zona del alto Golfo de California cercana a la costa de Baja California que a la zona cercana a la costa de Sonora; y los contaminantes que provengan de fuentes remotas (v.g.: de la parte central del Golfo de California) acarreados por las corrientes marinas, afectarán más a la zona cercana a la costa de Sonora que a la zona cercana a la costa de Baja California. Comparando la distribución superficial de oxígeno disuelto para el crucero de octubre con la del crucero de diciembre se puede deducir que los contaminantes acarreados por el Río Colorado tales como pesticidas concentrados en organismos planctónicos y restos orgánicos en suspensión, y los adsorbidos en sedimentos en suspensión, son incorporados al medio marino de una manera tan irregular como el régimen pluvial de la zona. Lo anterior indica que la cuantificación de los aportes de contaminantes por vía hidráulica, al alto golfo, solamente se puede presentar en términos de cantidades totales por año, y no en forma de un flujo continuo.

## RECONOCIMIENTOS

El presente trabajo fué realizado bajo contrato número OQC-7202 para la Dirección General de Acuicultura de la Secretaría de Recursos Hidráulicos. Los autores agradecen a Daniel Muñoz Ferreira su disposición favorable para que este trabajo sea publicado. El presente trabajo fué también subvencionado, en parte pequeña, por la Institución Scripps de Oceanografía de la Universidad de California. Agradecemos a Richard Schwartzlose de Scripps su gran y desinteresada disposición para ayudarnos. Agradecemos a John Hendrickson de la Universidad de Arizona el habernos permitido utilizar la embarcación ADVENTYR para la realización de este trabajo, y el haber puesto a nuestra disposición las copias de las fotografías tomadas por el satélite ERTS-I, de las cuales se incluye una en este informe. Finalmente agradecemos la valiosa colaboración en los cruceros de los compañeros Bernardo P. Flores Baez y Jorge A. Rivera, y del patrón del ADVENTYR David Cabrera González. Este trabajo es parte de la tesis

profesional de Luis A. Galindo Bect, para obtener el título de oceanólogo.

## INTRODUCCIÓN

En octubre de 1972 se dió comienzo a los estudios hidrológicos del alto Golfo de California (de aproximadamente 31°N hacia el norte), como parte de los trabajos que la Unidad de Ciencias Marinas ha estado realizando para la Secretaría de Recursos Hidráulicos. Los objetivos de estos estudios son los siguientes:

a) Conocer el cuadro ambiental en el alto Golfo de California. Es decir, conocer la distribución espacial en esta zona, de las diferentes propiedades hidrológicas, físicas y químicas, y los cambios de esta distribución en función del tiempo a través de un ciclo anual. Esto se podrá utilizar para correlacionarlo con la ecología de las diferentes especies biológicas, sobre todo las de importancia comercial como el camarón y la totoaba.

b) Proveer información sobre la dinámica física y química del ecosistema en el alto Golfo de California, como una herramienta más en los estudios de contaminación, que permita dilucidar los mecanismos de incorporación de los contaminantes al medio ambiente marino. Para este fin, al contar con la información completa después de un año de estudio, se podrán construir modelos que permitirán predecir con bastante precisión el impacto de contaminantes en el ecosistema.

Las características hidrológicas, físicas y químicas, de nuestra área de interés, no se habían estudiado antes de que este trabajo diera comienzo con el crucero que se realizó en octubre 1972. Rosenberg (1969) realizó una revisión de los trabajos publicados sobre las características físicas y químicas oceanológicas de la parte norte del golfo (de Isla Ángel de la Guarda hacia el norte) y no presenta datos de nuestra área de interés. Thompson (1969) reportó algunos pocos datos de salinidad, tomados en marzo de 1968 en la costa de Sonora, cerca de Santa Clara. El estudio de esta parte del Golfo de California es muy importante para un mejor entendimiento de la dinámica del golfo como un todo, y para una mejor comprensión del mismo como ecosistema.

## OBTENCIÓN DE DATOS

Durante otoño de 1972 se realizaron dos cruceros utilizando la embarcación ADVENTYR, del 25 al 27 de octubre y del 9 al 14 de diciembre. La posición de las estaciones de muestreo no fué la misma en los dos cruceros (Figuras 1 y 2). En cada crucero se hicieron determinaciones de temperatura *in situ* (T°C), de pH y de concentración de oxígeno disuelto (O<sub>2</sub>); y se tomaron muestras de salinidad (S<sup>0</sup>/<sub>00</sub>), alcalinidad y nutrientes (fosfatos, nitratos y silicatos) para su posterior análisis en el laboratorio. Las determinaciones de O<sub>2</sub> se realizaron de acuerdo con el procedimiento descrito por Strickland y Parsons

(1965) para el método Macro-Winkler. La T°C se determinó utilizando termómetros reversibles. El pH se determinó con un potenciómetro Orion, modelo 407, y la S<sup>0</sup>/<sub>00</sub> se determinó con un salinómetro Beckman, modelo 118WA200. En el presente escrito no se presentan resultados de alcalinidad y nutrientes; solamente se describe la distribución superficial de O<sub>2</sub>, T°C, S<sup>0</sup>/<sub>00</sub> y pH.



FIGURA 1. Localización de las estaciones hidrológicas ocupadas en el crucero de octubre.

Al estudiar la distribución superficial de los parámetros físicos y químicos se debe tomar en cuenta que en un determinado crucero las diferentes estaciones no se ocupan simultáneamente. En algunas ocasiones existen no solamente horas sino hasta días de diferencia entre los tiempos en que se ocuparon las diferentes estaciones. Al estar dibujando una gráfica que muestra la distribución superficial de una variable estamos asumiendo que los datos se tomaron simultáneamente, por lo tanto la gráfica es sólo una aproximación a la realidad. Si los rangos de variación en función del tiempo exclusivamente, son relativamente pequeños para la duración del crucero, la aproximación es aceptable. En el caso particular de nuestra zona de interés, más importante que las variaciones que ocurren de día a día, son las que ocurren a través de un día determinado en que se realizan muestreos. Por ejemplo, en un punto geográfico determinado en el

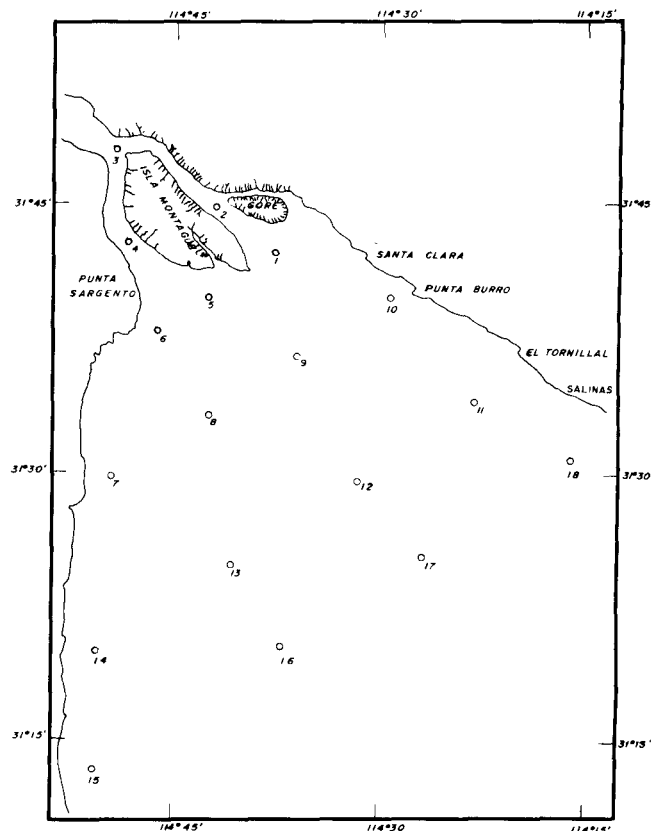

FIGURA 2. Localización de las estaciones hidrológicas ocupadas en el crucero de diciembre.

alto Golfo de California, la diferencia en los valores de un parámetro de las 12:00 a las 24:00 horas del mismo día es mayor que de las 12:00 horas de un día a las 12:00 horas del día siguiente. En un escrito posterior se discutirá la variación diurna de  $T^{\circ}C$ ,  $S^{\circ}/_{00}$ ,  $O_2$  y pH en esta zona.

**RESULTADOS**

Tanto durante el mes de octubre como durante el mes de diciembre, la temperatura superficial en la parte norte del Golfo de California disminuye del sureste al noroeste (Figuras 3 y 4). Durante el crucero de octubre la temperatura superficial más baja fué de  $20.20^{\circ}C$  y se registró al norte de isla Montague (Estación 3, Figura 1). Durante el crucero de diciembre fué de  $8.25^{\circ}C$  y se registró al oeste de isla Montague (Estación D3, Figura 2). En general las temperaturas más bajas se registran al norte de isla Montague. El hecho de que durante el crucero de diciembre se registrara al oeste de isla Montague se debió a que la Estación D3, localizada en ese sitio, se ocupó a las 06:55 horas, mientras que la D4 (Figura 2), localizada al norte de isla Montague, se ocupó a las 14:47 horas del día anterior. La temperatura superficial en la Estación D4 fué mayor que en la D3 por el efecto de la variación diurna debido a la radiación solar.

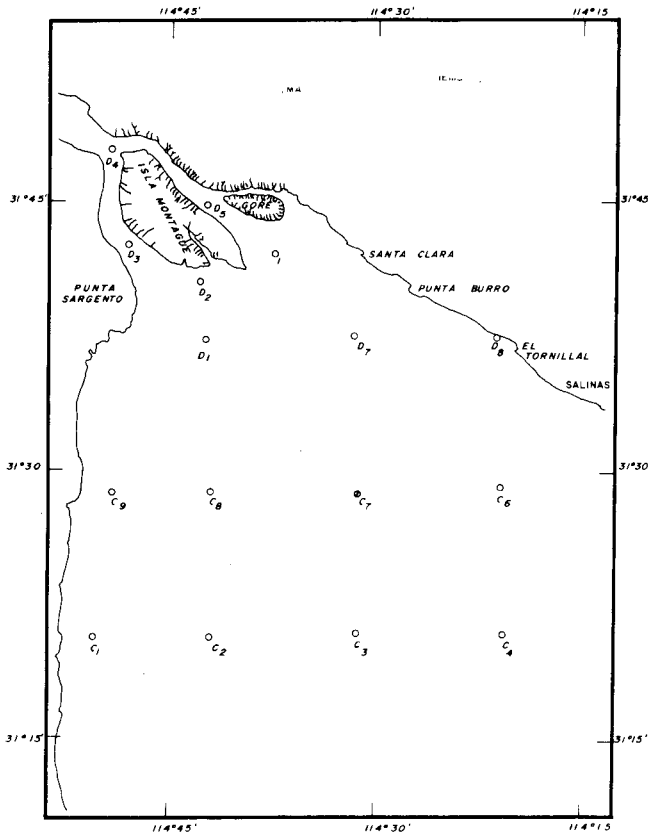
En el área estudiada, la temperatura superficial más elevada durante el crucero de octubre fué de



FIGURA 3. Distribución superficial de  $T^{\circ}C$  para el crucero de octubre.



FIGURA 4. Distribución superficial de  $T^{\circ}C$  para el crucero de diciembre.

24.00°C y se registró en la estación más oriental (Estación 18, Figura 1). Durante el crucero de diciembre fué de 17.55°C (Estación C6, Figura 2). La distribución de temperatura fué más irregular durante octubre que durante diciembre (Figuras 3 y 4).

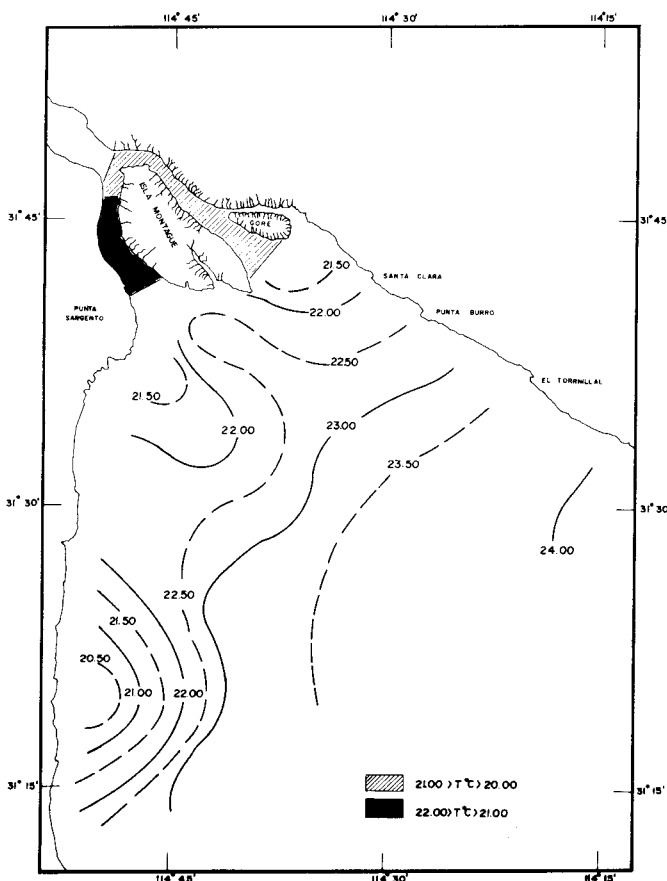
A diferencia de las distribuciones de T°C, las de  $S^0/_{00}$  para los dos cruceros no son similares (Figuras 5 y 6). Para el crucero de octubre la distribución superficial de  $S^0/_{00}$  muestra una lengüeta de valores altos, proveniente del sur, en la parte central (Figura 5). A los lados de esta lengüeta los valores decrecen hacia ambas costas. Los valores más bajos se registraron al norte de isla Montague, donde el mínimo fué de  $35.28^0/_{00}$ . Las aguas cercanas a la costa de Baja California tenían en general valores de salinidad más bajos que los de las aguas cercanas a la costa de Sonora (Figura 5). La  $S^0/_{00}$  superficial más alta registrada durante el crucero de octubre fué de  $36.18^0/_{00}$  (Estación 13, Figura 1).

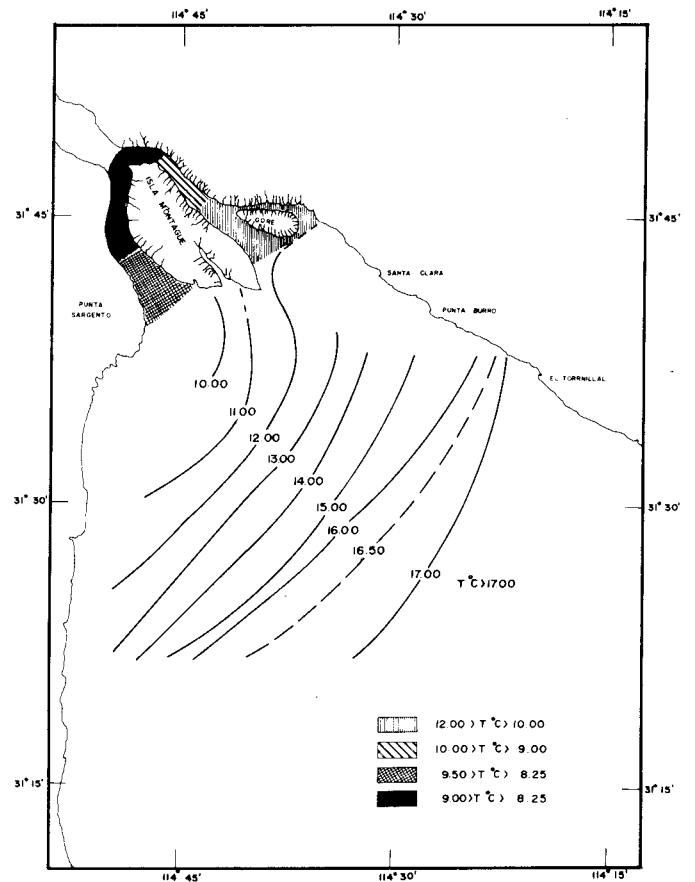

FIGURA 5. Distribución superficial de  $S^0/_{00}$  para el crucero de octubre.

Para el crucero de diciembre la distribución superficial de  $S^0/_{00}$  muestra una lengüeta de valores altos, que se origina en la parte cercana a la costa de Baja California y se extiende hacia la costa de Sonora (Figura 6). La situación es casi inversa que en el crucero de octubre. El máximo de  $S^0/_{00}$  ( $37.73^0/_{00}$ ) se registró al oeste de isla Montague (Estación D3, Figura 2). Las más bajas salinidades se registraron en la parte oriental de nuestra zona de estudio, cerca de la costa de Sonora. En general la  $S^0/_{00}$  aumenta hacia el noroeste (Figura 6).

Semejante al caso de la  $S^0/_{00}$ , la distribución superficial de  $O_2$  para el crucero de octubre no es similar a la del crucero de diciembre (Figuras 7 y 8). Durante el crucero de octubre la distribución superficial de  $O_2$  fué relativamente compleja (Figura

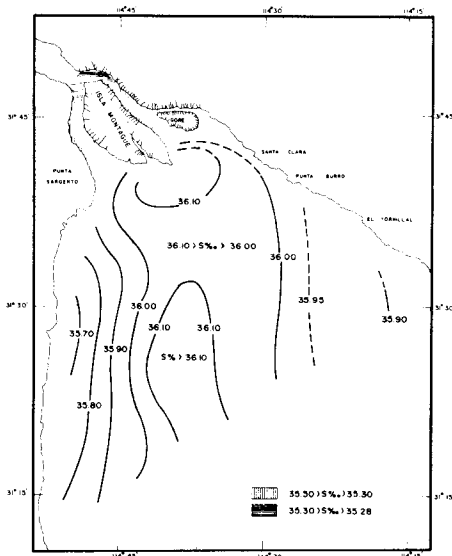

FIGURA 6. Distribución superficial de  $S^0/_{00}$  para el crucero de diciembre.



FIGURA 7. Distribución superficial de  $O_2$  para el crucero de octubre.

7). La única tendencia general se registró en la parte norte donde el  $O_2$  aumentó de la costa de Sonora a la costa de Baja California. El valor superficial mínimo de  $O_2$  se registró al norte de isla Montague y fué de 1.33 ml/l. El máximo fué de 4.96 ml/l y se registró cerca de la costa de Baja California, en la Estación 7 (Figura 1).

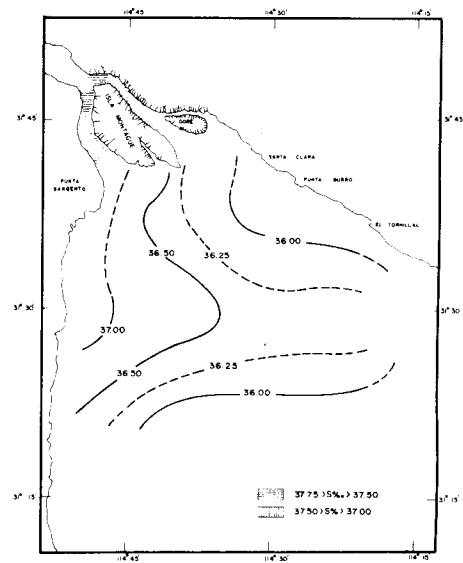

FIGURA 8. Distribución superficial de  $O_2$  para el crucero de diciembre.

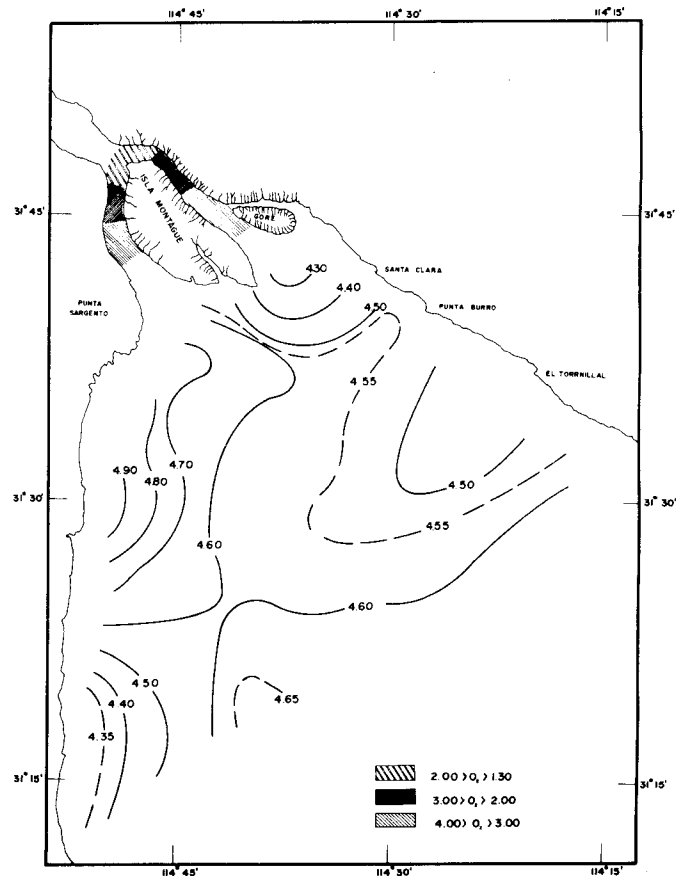
Durante el crucero de diciembre, la distribución superficial de  $O_2$  indica en general un aumento de sureste a noroeste (Figura 8). Las isogramas de  $O_2$  muestran un comportamiento muy semejante al de las isotermas (Figuras 4 y 8). El valor superficial máximo de  $O_2$  para el crucero de diciembre se registró al oeste de isla Montague (Estación D3, Figura 2) y fué de 6.49 ml/l. El valor mínimo fué de 4.90 ml/l y se registró en la Estación C2 (Figura 2).

Durante el crucero de octubre el pH superficial mostró en general la tendencia a disminuir del suroeste al noroeste (Figura 9). El valor mínimo superficial de pH se registró, al igual que el de  $O_2$  y  $T^{\circ}C$ , al norte de isla Montague (Estación 3, Figura 1) y fué de 7.83. El valor máximo se registró en la Estación 14 (Figura 1) y fué de 8.32.

La distribución superficial de pH en el crucero de diciembre mostró una característica especial, no

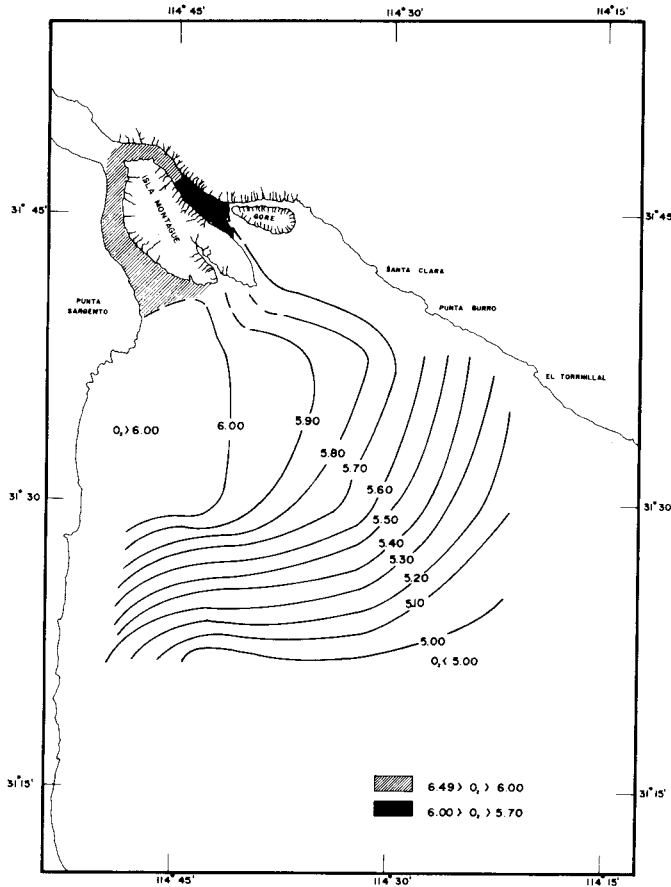

FIGURA 9. Distribución superficial de pH para el crucero de octubre.

mostrada por ninguno de los parámetros mencionados anteriormente (Figura 10). Los valores de pH fueron mínimos en la parte sur, en el centro, y aumentaron en forma concéntrica hacia la costa (Figura 10). El valor mínimo superficial de pH se registró en la Estación C3 (Figura 2) y fué de 7.63. El valor máximo se registró al este de isla Montague (Estación D5, Figura 2) y fué de 8.27.

## DISCUSIONES

La distribución superficial de  $T^{\circ}C$ ,  $S^{\circ}/_{00}$ ,  $O_2$ , y pH para los cruceros de octubre y diciembre de 1972 muestran claramente la tremenda variabilidad de las condiciones ambientales en nuestra zona de estudio. La influencia de la profundidad y de los fenómenos atmosféricos, tales como los cambios de temperatura del aire y la precipitación pluvial, en esta variabilidad, se puede deducir comparando los resultados de octubre con los de diciembre. Por ejemplo, en las aguas superficiales de la zona circundante a isla Montague la diferencia de  $T^{\circ}C$  entre octubre y diciembre fué de casi  $12^{\circ}C$ , mientras que en la parte más suroriental de nuestra zona de estudio la diferencia entre octubre y diciembre fué solamente de cerca de  $6.5^{\circ}C$ . Esto se debe a que las aguas cercanas a isla Montague son muy someras, de

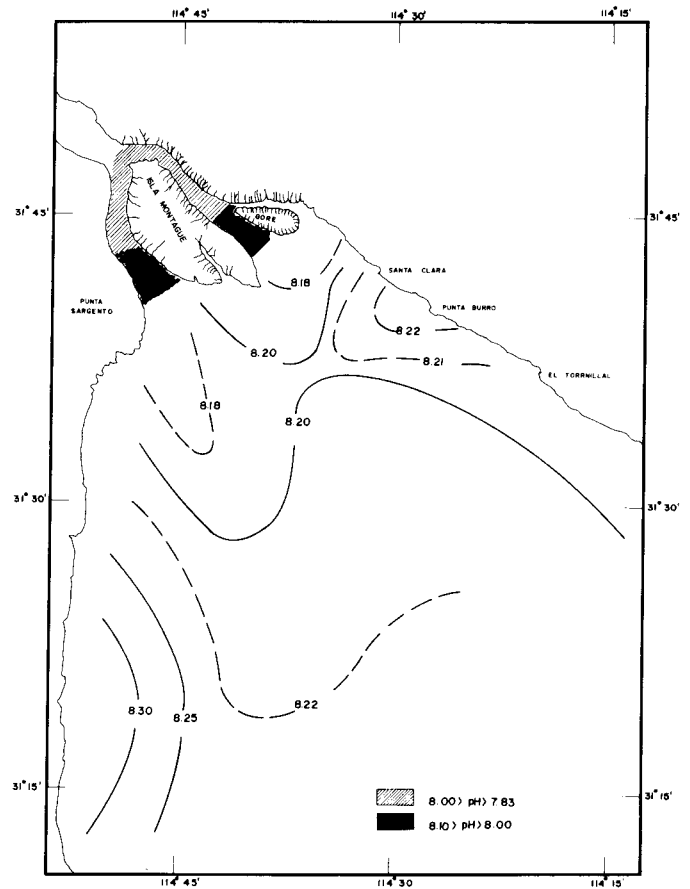

FIGURA 10. Distribución superficial de pH para el crucero de diciembre.

tal manera que los cambios de temperatura atmosférica las afectan mucho más que a las aguas de más al sur donde la profundidad es mayor.

En los días que precedieron al crucero de octubre se registró una precipitación pluvial relativamente abundante para esta zona. En la estación meteorológica de la Secretaría de Recursos Hidráulicos en Mexicali, se registraron 21.0 y 55.5 mm de precipitación pluvial el 6 y 7 de octubre respectivamente. En la estación de San Felipe, B.C., se registraron 240 mm el día 5 de octubre; para el resto de los días que precedieron al crucero no se reportaron datos meteorológicos de la estación de San Felipe (Rep. de datos, Dir. de Hidrol. Div. Ensenada, SRH). La Figura 5 muestra claramente la influencia de la precipitación pluvial en la distribución superficial de  $S^{0/00}$  para el crucero de octubre. Las bajas salinidades en las aguas cercanas a la costa son producto de la influencia de escurrimientos (arroyos, etc.). El mínimo de  $S^{0/00}$  al norte de isla Montague es producto de la aportación de agua dulce del sistema del delta del Río Colorado, durante estas lluvias.

Groen (1969) describe dos tipos de situaciones en lagunas costeras: una llamada estuarina y otra llamada antiestuarina. Cuando el aporte de agua

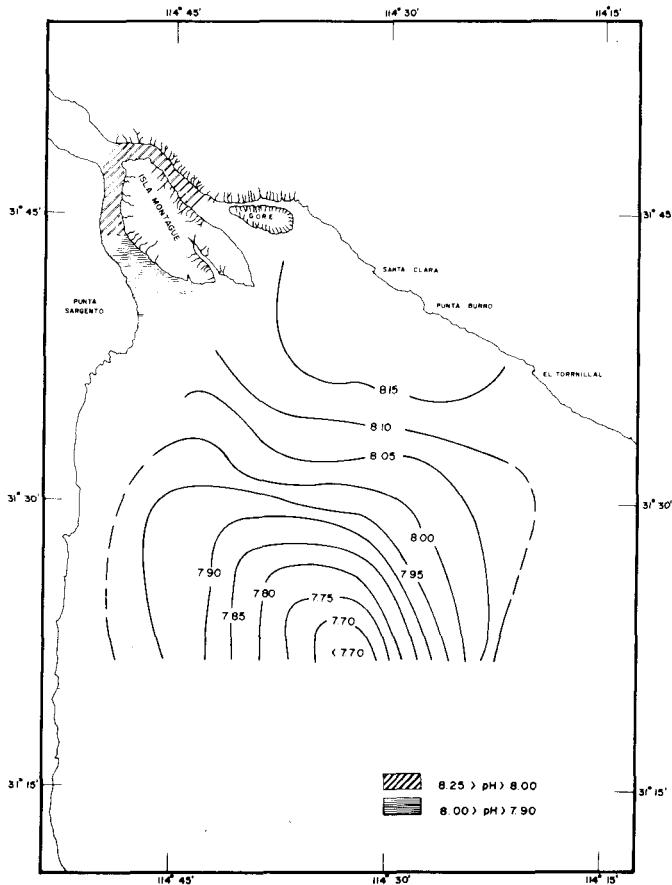
dulce por ríos, arroyos, etc., excede a la evaporación, existe una situación estuarina; en el caso inverso la situación es antiestuarina. Una clasificación semejante a este puede hacerse para zonas como el alto Golfo de California. Las Figuras 5 y 6 muestran que durante el crucero de octubre la situación era estuarina, y durante el crucero de diciembre era antiestuarina. El ascenso de  $S^{0/00}$  mostrado por la Figura 5, de la desembocadura del Río Colorado a mar adentro, es una condición que solamente puede explicarse en términos de la influencia del aporte de agua dulce por el río. Mientras que el gradiente de  $S^{0/00}$  mostrado por la Figura 6, indica que en diciembre la evaporación fué mayor que el aporte de agua dulce.

La distribución superficial de  $T^{\circ}C$  y  $S^{0/00}$  para los dos cruceros (Figuras 3, 4, 5 y 6) indica que la circulación neta, sin considerar el flujo y reflujo de las mareas, es rotatoria en el sentido contrario a las manecillas del reloj. Thompson (1969) reportó que mediciones de corrientes de mareas mar adentro indican un sistema rotatorio en el sentido de las manecillas del reloj, mientras que mediciones a lo largo de la costa indican una circulación contraria a las manecillas del reloj. Thompson (1969) indicó también que la distribución de sedimentos, la turbidez y la orientación de ondas grandes de arena en las marismas, indican una circulación contraria a las manecillas del reloj. Si la circulación neta es rotatoria en el sentido contrario al de las manecillas del reloj, se debe observar una influencia de las condiciones hidrológicas de la zona circundante a isla Montague en la zona cercana a la costa de Baja California; y se debe observar una influencia de las condiciones hidrológicas de la región oceánica del Golfo (al sur de nuestra zona de estudio) en la zona cercana a la costa de Sonora, cerca de Santa Clara. En efecto, las Figuras 3 y 4 muestran que las temperaturas mínimas se registraron en la zona de isla Montague y las temperaturas en la zona cercana a la costa de Baja California fueron más bajas que las de la zona cercana a Sonora. La Figura 5 muestra que el mínimo de  $S^{0/00}$  se registró al norte de isla Montague, y las salinidades de la zona cercana a Baja California fueron más bajas que las de la zona cercana a Sonora. La Figura 6 muestra que el máximo de  $S^{0/00}$  se registró en la zona de isla Montague y las salinidades de la zona cercana a la costa de Baja California fueron más altas que las de la zona cercana a la costa de Sonora.

Fotografías espaciales tomadas por el satélite ERTS-I (Earth Resources Technology Satellite-I), puesto en órbita y operado por la National Aeronautical & Space Administration (NASA) de los Estados Unidos de América, muestran muy claramente la distribución de sedimentos en suspensión en el norte del Golfo de California (Fotografía 1). La Fotografía 1, tomada con luz infrarroja ( $8000$  a  $11000 \text{ cm} \times 10^{-8}$ ) muestra la

distribución de las partículas en suspensión en nuestra zona de estudio. Esta fotografía muestra que la mayor turbidez se encuentra en la boca del Río Colorado, disminuyendo hacia mar adentro. En la parte cercana a la costa de Baja California esta turbidez se extiende más hacia el sur que en la parte cercana a la costa de Sonora, indicando también una circulación rotatoria en el sentido contrario al de las manecillas del reloj. La mayor parte de esta turbidez son arcillas en suspensión.

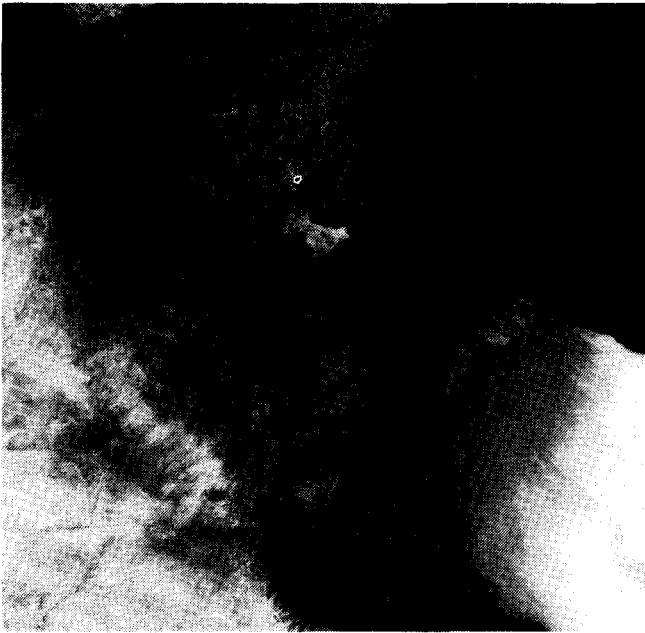

FOTOGRAFÍA 1. Fotografía espacial tomada por el satélite ERTS-I, con luz infrarroja ( $8000$  a  $11000 \text{ cm} \times 10^{-8}$ ) Alto Golfo de California.

Las gráficas y fotografía presentadas en este trabajo parecen resolver la discrepancia presentada por Thompson (1969) a favor de la circulación rotaria en el sentido contrario a las manecillas del reloj. Esto es muy importante para dilucidar diferentes fenómenos, pero en este trabajo nos concretamos a establecer la relación que tiene con los acarrees de contaminantes al alto Golfo de California. De acuerdo con lo establecido anteriormente, los contaminantes de cualquier tipo que provengan de la zona del delta del Río Colorado, acarreados por las aguas del río, afectarán con mucha más intensidad a la zona del alto Golfo de California cercana a la costa de Baja California que a la zona cercana a la costa de Sonora; y los contaminantes que provengan de fuentes remotas (v.g.: de la parte central del Golfo de California) acarreados por las corrientes marinas, afectarán más la zona cercana a la costa de Sonora que a la zona cercana a la costa de Baja California. Estas conclusiones no se pueden aplicar directamente a la explicación de la distribución de pesticidas porque es necesario considerar cuantitativa y conjuntamente los acarrees eólicos y

los acarrees hidráulicos de los contaminantes. Para esto se necesitan datos meteorológicos bastante completos y de contenido de pesticidas en los polvos acarreados por los vientos.

La distribución superficial de  $O_2$  para el cruce de octubre (Figura 7) es relativamente compleja. Posiblemente esta complejidad se debió al aporte de materia orgánica acarreada por los escurrimientos producto de la precipitación pluvial. La oxidación de esta materia orgánica produjo un consumo de oxígeno más rápido que el suministro realizado por intercambio con la atmósfera. La distribución del porcentaje de saturación de  $O_2$  (Figura 11) para el cruce de octubre muestra valores abajo de 100% en casi toda nuestra área de interés. Solamente en la Estación 7 (Figura 1) se registró un 100% de saturación. En general la distribución de pH concuerda con la de  $O_2$  (Figuras 7 y 9). Las lengüetas de valores bajos de  $O_2$  y de % de saturación de  $O_2$  (Figuras 7 y 11) posiblemente indican entradas de arroyos de aporte considerable. El mínimo de  $O_2$  registrado al norte de isla Montague (1.33 ml/l) es extremadamente bajo. En un principio se dudó de la veracidad del dato, pero se corroboró por un valor también muy bajo de pH (7.83, Figura 9). Esto indica que el aporte de materia orgánica en descomposición, por el Río Colorado, fué muy abundante. Okuda (1969) reportó un valor superficial mínimo de  $O_2$  de 0.6 ml/l en la Laguna Unare, una laguna costera de Venezuela.



FIGURA 11. Distribución superficial de porcentaje de saturación de  $O_2$  para el cruce de octubre.

La distribución superficial de  $O_2$ , para el crucero de diciembre (Figura 8), al igual que la de salinidad, no muestra efectos de ningún aporte de agua dulce. Al no haber aporte de materia orgánica en descomposición el factor determinante que gobierna la distribución de  $O_2$  es la temperatura y, en función de ella, el intercambio gaseoso con la atmósfera. Por esta razón, las isogramas de  $O_2$  se comportan muy similar a las isotermas (Figuras 4 y 8) con valores elevados de  $O_2$  donde la temperatura es baja, y viceversa. La distribución del porcentaje de saturación de  $O_2$  para este crucero (Figura 12) muestra una distribución más regular que la de octubre (Figura 11), y con valores más cercanos a 100%. En la parte central de la zona de interés el porcentaje de saturación fué mayor de 100. El valor más alto registrado fué de 102, en la Estación C7 (Figura 2). Los valores más bajos se registraron en la parte sur (Figura 12), con un valor mínimo de 88 en la Estación C2 (Figura 2). Una posible explicación para estos valores bajos del porcentaje de saturación de  $O_2$  es la de un cambio rápido de temperatura hacia valores más bajos, acompañado de procesos de mezcla y difusión más lentos en la parte sur que en la parte norte de nuestra área de interés.

Del hecho de que la distribución de  $O_2$  para octubre muestra la influencia de la descomposición de materia orgánica, mientras que la de diciembre no la muestra, se puede deducir una conclusión sobre

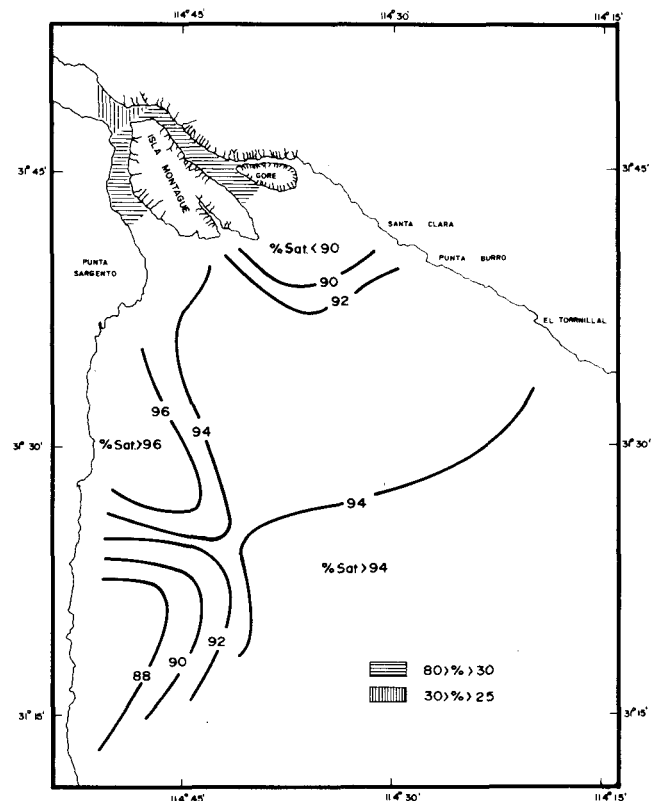

FIGURA 12. Distribución superficial de porcentaje de saturación de  $O_2$  para el crucero de diciembre.

el aporte de contaminantes por el Río Colorado al alto Golfo de California. Los contaminantes, tales como pesticidas concentrados en organismos planctónicos y restos orgánicos en suspensión, y los adsorbidos en sedimentos en suspensión, son incorporados al medio marino de una manera tan irregular como el régimen pluvial. Si existiera un aporte regular de materia orgánica y sus contenidos de contaminantes, por el Río Colorado, su influencia en la distribución de  $O_2$  se hubiera detectado no solamente en octubre sino también en diciembre. Lo anterior indica que la cuantificación de los aportes de contaminantes por vía hidráulica, al alto golfo, solamente se puede presentar en términos de cantidades totales por año, y no en forma de un flujo continuo.

La distribución de pH para el crucero de diciembre (Figura 10) no se correlaciona con la de los otros parámetros. Para explicar esta distribución se hace necesario contar con mayor información (v.g.: sobre alcalinidad). El pH detecta un fenómeno en la parte sur, central, de nuestra zona de estudio, que no detectan los demás parámetros reportados en este escrito.

El tipo de información hidrológica que se presenta en este escrito no solamente puede ser utilizado para entender mejor la dinámica del ecosistema y la distribución de los pesticidas en el mismo. También se puede utilizar para construir modelos hidráulicos que permitan predecir la dispersión de un afluente. Con relación a los planes que existían para construir una planta nuclear de doble propósito, de desalinización y productora de energía eléctrica, en algún lugar cercano a Santa Clara, Son. (en nuestra área de interés), Matthews y Rosenberg (1969) mencionaron que para predecir el impacto de un afluente de alta salinidad y temperatura, producida por la planta, se hacía necesario contar con una mejor información oceanológica del área. Al no contar con los datos necesarios, Matthews y Rosenberg (1969) asumieron que la salinidad del alto Golfo de California era invariable en el tiempo y el espacio, y su valor era la media de las registradas en Puerto Peñasco, Son. En base a esto construyeron un modelo hidráulico para predecir el efecto de las aguas de desecho de la planta nuclear, con alta salinidad y temperatura, en la hidrología del alto golfo. Los resultados obtenidos por Matthews y Rosenberg (1969) pueden mejorarse mucho si se aplican las distribuciones espaciales de salinidad y temperatura que hemos encontrado en nuestros cruceros, en lugar de asumir valores constantes. Para que esto sea significativo debe utilizarse la información colectada a través de un ciclo anual. Matthews y Rosenberg (1969) consideraron sus resultados como "muy pobres". Un modelo semejante al de estos autores se puede desarrollar para predecir el efecto de las aguas de desecho de la geotermoelectrica de Cerro Prieto, si estas aguas se introducen al medio marino. Éste es uno de los aspectos del trabajo que está en desarrollo.

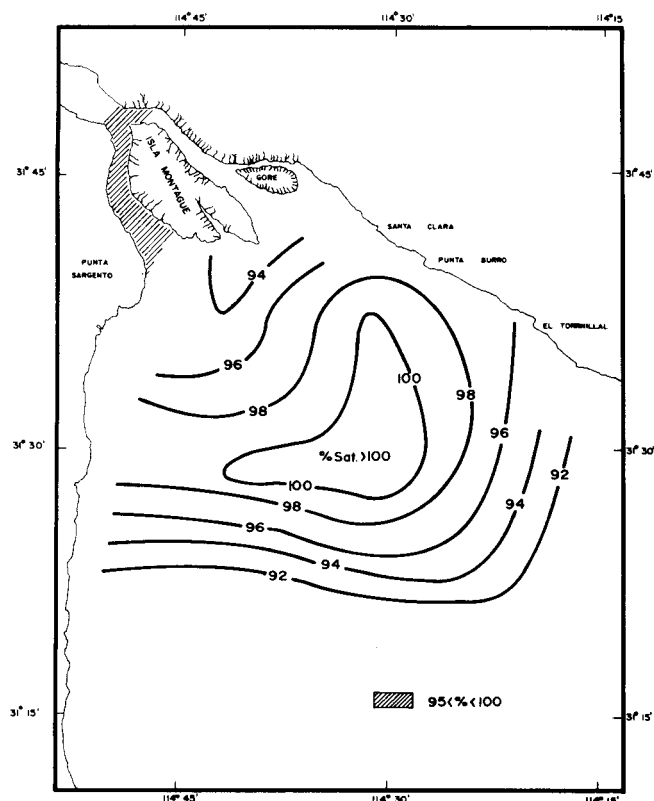

## BIBLIOGRAFÍA

- Groen, P. 1969. Physical Hydrology of Coastal Lagoons. *En: Lagunas Costeras, Un Simposio*. Ed. A. Ayala-Castanares y F. B. Phleger. UNAM-UNESCO, México, D.F.
- Matthews, J. B., y D. H. Rosenberg. 1969. Possible effects of the Brine Effluents on Salinities of Northern Gulf Waters.: 127-139. *In: Environmental impact of brine effluents on Gulf of California*, U.S. Dept. Int., Saline Water, Res. and Dev. Prog. Rept., (387): 1-207.
- Okuda, T. 1969. Estudio comparativo de las condiciones hidrográficas de las lagunas Unare y Tacarigua, Venezuela. *En: Lagunas Costeras, Un Simposio*. Ed. A. Ayala Castanares y F. B. Phleger. UNAM-UNESCO, México, D.F.
- Rosenberg, D. H. 1969. Physical Oceanographic Features: 1) Distribution of Temperature, Salinity and Oxygen: 16-40. *In: Environmental impact of brine effluents on Gulf of California*. U.S. Dept. Int., Saline Water Res. and Prog. Rept., (387): 1-207.
- Strickland, H. D., y T. R. Parsons. 1965. A practical handbook of sea water analysis. Fish. Res. Bd. Canada, Bull., (167): 1-311.
- Thompson, R. W. 1969. Tidal currents and general circulation: 51-55. *In: Environmental impact of brine effluents on Gulf of California*. U.S. Dept. Int., Saline Water Res. and Dev. Prog. Rept., (387): 1-207.
- Thomson, D. A. 1969. Résumé of Site Visits to the El Golfo de Santa Clara Region: 104-109. *In: Environmental impact of brine effluents on Gulf of California*. U.S. Dept. Int., Saline Water Res. and Dev. Prog. Rept., (387): 1-207.

# HIDROLOGÍA DE LA BAHÍA DE SAN QUINTÍN, BAJA CALIFORNIA, EN INVIERNO Y PRIMAVERA

AMELIA GUADALUPE CHÁVEZ DE NISHIKAWA

y

SAÚL ALVAREZ BORREGO

Unidad de Ciencias Marinas  
Universidad Autónoma de Baja California  
Ensenada, Baja California

## ABSTRACT

Results of the surface distribution of temperature, salinity, dissolved oxygen concentration, pH and alkalinity in San Quintín Bay, Baja California, for winter and spring, are presented and discussed. Results of a study of the diurnal variation of these parameters at the beginning of spring also are presented and discussed. Based on the results we conclude that culturing *Crassostrea virginica* (american oyster) is not recommended, and culturing *C. gigas* (japanese oyster) is possible, but salinity conditions are better for *Ostrea lurida* and *O. edulis*.

## RESUMEN

Se presentan y discuten los resultados de la distribución superficial de temperatura, salinidad, concentración de oxígeno disuelto, pH y alcalinidad, en Bahía San Quintín, Baja California; y los cambios de dicha distribución a través de invierno y primavera de 1973. Además, se presentan y discuten los resultados de un estudio de la variación diurna de estos parámetros a principios de primavera. En base a los resultados, se concluye que el cultivo de *Crassostrea virginica* (ostión americano) no es recomendable; que el cultivo de *C. gigas* (ostión japonés) es adecuado, pero que las condiciones de salinidad son mejores para *Ostrea lurida* y *O. edulis*.

## RECONOCIMIENTOS

Este estudio es parte del "Programa Piloto para el Cultivo de Ostión y Determinación de Parámetros Ambientales en Bahía de San Quintín, B.C." que la Unidad de Ciencias Marinas de la U.A.B.C. está llevando a cabo bajo contrato para el Instituto Nacional de Pesca de la S.I.C. y la Dirección de Acuicultura de la S.R.H. Agradecemos a Luis Kasuga Osaka, Director del I.N.P., y a Daniel Muñoz Ferreira, Director de Acuicultura, su disposición favorable para que este trabajo se publique. La realización de este trabajo se ha hecho posible en parte gracias a la existencia del equipo oceanográfico que se adquirió con la donación que el Presidente de la República Lic. Luis Echeverría Alvarez hizo a la U.C.M. de la U.A.B.C. Agradecemos a los compañeros Manuel Acosta Ruiz, Jorge Alberto Rivera, Victor Gendrop Funes, Guillermo Ballesteros Grijalva, Guadalupe García de

Ballesteros, Antonio K. Nishikawa Kinomura y Gabriela Rojo su valiosa colaboración en los trabajos de campo.

Deseamos hacer especial mención de nuestra gratitud a Alfonso Vela por su gran y desinteresada ayuda, permitiéndonos utilizar sus lanchas y equipo en San Quintín.

Una parte de este artículo fue publicada anteriormente en CALAFIA (2[3]); el artículo completo como aquí se presenta constituye la tesis profesional que Amelia G. Chávez de Nishikawa presentó a la E.S.C.M. para obtener el título profesional de Oceanólogo.

## INTRODUCCIÓN

Desde principios de la década pasada se han venido realizando en la Bahía de San Quintín, B.C., numerosos estudios, tanto por investigadores nacionales como extranjeros. A partir de algunas de las observaciones que se han efectuado, se infiere la posibilidad de utilizar dicha bahía, actualmente improductiva desde el punto de vista pesquero, como área de maricultivo importante para la economía regional.

Uno de los problemas que se han venido desarrollando en Baja California es el hecho de que los recursos pesqueros de aguas costeras, que se han estado explotando comercialmente, están disminuyendo paulatinamente. Esto ocurre al mismo tiempo que la membresía de las diferentes cooperativas pesqueras aumenta, como resultado del incremento demográfico de la Península (Acosta y Alvarez, 1973).

Alvarez y Schwartzlose (1973), al hacer un planteamiento de algunos problemas oceanológicos de los mares adyacentes a la península de Baja California, mencionaron la importancia del conocimiento de la hidrología de bahías y lagunas costeras como una infraestructura en la que se debe basar el desarrollo de maricultivos. Esta importancia se basa esencialmente en que las diferentes especies cultivables solo pueden desarrollarse de una manera óptima dentro de ciertos rangos de variación de los diferentes parámetros ecológicos físicos y químicos. Los parámetros más importantes son la temperatura y la salinidad.

En el presente trabajo sólo se exponen y discuten los resultados de la distribución superficial de

temperatura ( $T^{\circ}C$ ), salinidad ( $S^{\circ}/_{00}$ ), concentración de oxígeno disuelto ( $O_2$ ), pH y alcalinidad; y los cambios de dicha distribución a través de invierno y primavera de 1973. Además se presentan y discuten los resultados de un estudio de la variación diurna de los parámetros mencionados, a principios de primavera.

La Bahía de San Quintín está localizada en la costa noroccidental de Baja California entre los  $30^{\circ} 24' N$  y  $30^{\circ} 30' N$ ; y  $115^{\circ} 57' W$  y  $116^{\circ} 01' W$ . La distancia por carretera desde Ensenada es de 200 Kms. Tiene un área de 11.7 millas náuticas cuadradas y se comunica con el mar por un canal estrecho. Esta dividida en dos brazos, oeste y este (Barnard, 1964). Al brazo oeste se le llama Bahía Falsa, y al brazo este se le denomina propiamente Bahía San Quintín. En lo que se escribe a continuación el nombre Bahía San Quintín se referirá solamente al brazo este. Con excepción de los canales estrechos de hasta 7 metros de profundidad la mayor parte de la bahía tiene menos de 3 metros de profundidad (Figura 1).

Los sedimentos de la bahía son extraordinariamente variados desde limos hasta arenas gruesas, y las diversas clases de sedimentos

ocurren relativamente uniforme (Gorsline y Stewart, 1962).

La Fundación Beaudette patrocinó un estudio bastante intenso de la Bahía de San Quintín en los primeros años de la década pasada. Un gran número de los trabajos resultantes fueron publicados por la revista *Pacific Naturalist* (J. Menzies, 1962; L. Barnard, 1962, 1964; Gorsline y Stewart, 1962; Dawson, 1962; A. M. Keen, 1962; D. J. Reish, 1963).

### MÉTODOS DE OBTENCIÓN Y PROCESAMIENTO DE DATOS

Durante invierno y primavera se realizaron 4 viajes: el 3-4 de enero, el 10 de febrero, el 8 de abril y el 8 de mayo. En el primer y tercer viajes se cubrieron las estaciones hidrográficas mostradas en la Figura 2. En el cuarto viaje se cubrieron las estaciones hidrográficas mostradas en la Figura 3. En el segundo viaje debido a las malas condiciones del tiempo se cubrieron solamente las primeras 11 estaciones de la Figura 2. Además, a principios de primavera se ocuparon dos estaciones, durante 22 horas cada una, con el fin de estudiar la variación diurna de los diferentes parámetros. Estas estaciones



FIGURA 1. Plano de localización. Un minuto de diferencia en latitud es igual a una milla náutica. La batimetría está dada en brazas; solamente para mostrar la configuración del canal.



FIGURA 2. Localización de las estaciones hidrográficas ocupadas en el primer, segundo y tercer muestreos. Los triángulos oscuros indican los lugares donde se realizó el estudio de variación diurna.

se localizaron una en cada brazo de la bahía, cercanas a las estaciones 2 y 20 de la Figura 2, siendo su cercanía tal que se consideran representativas de esas estaciones.

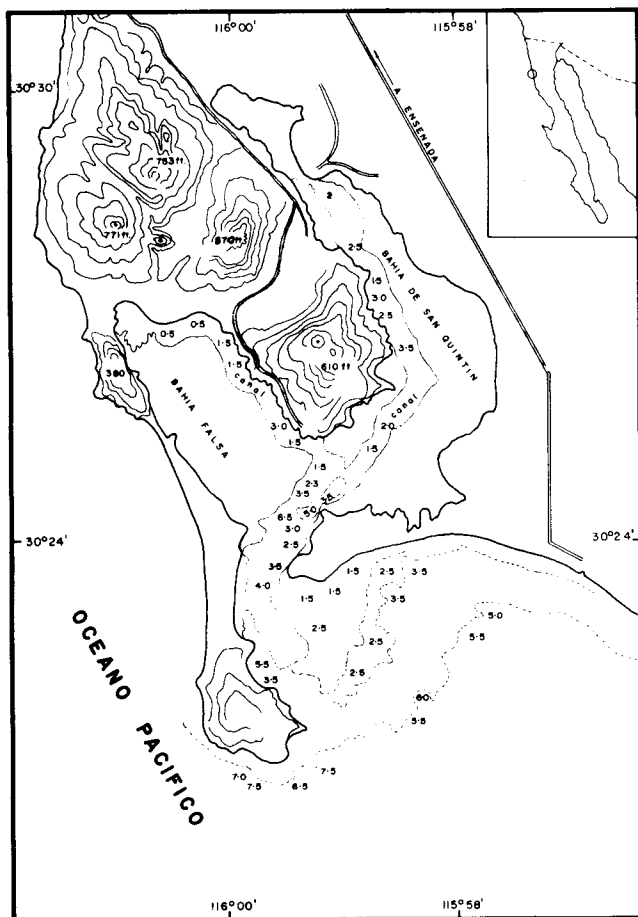
Al estar ocupando cada estación se determinaba la T°C, el pH y las condiciones meteorológicas (velocidad y dirección del viento y porcentaje de nubosidad) y se tomaban muestras de  $S^{0/00}$  y  $O_2$ , para su posterior análisis en el laboratorio. En el tercero y cuarto viajes de campo no se tomaron datos sobre pH y alcalinidad debido a fallas en el potenciómetro.

La T°C se determinó con un termómetro de cubeta con rango de  $-1^{\circ}\text{C}$  a  $51^{\circ}\text{C}$ ; la  $S^{0/00}$  con un salinómetro de inducción, marca Beckman, modelo 118WA200; el  $O_2$  por el método macro-Winkler descrito por Strickland y Parsons (1965); el pH y la alcalinidad se determinaron utilizando electrodos de vidrio y un potenciómetro Orión, modelo 407, de baterías; para determinar la velocidad y dirección del viento se utilizó un anemómetro Kahlsico, modelo 03AM120.

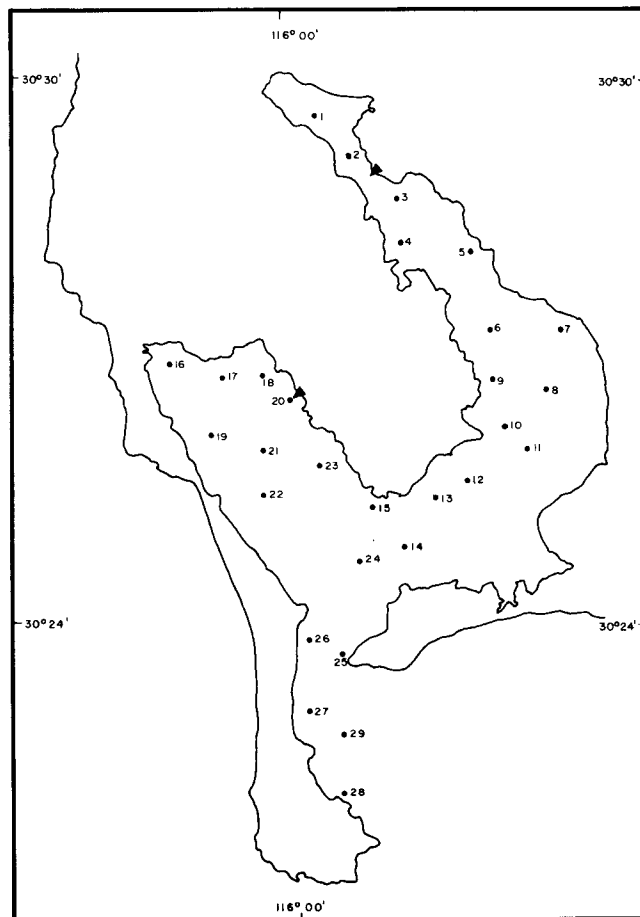
El porcentaje de saturación de oxígeno se calculó utilizando la siguiente fórmula:

$$\% = \frac{O_2}{O_2'} \times 100$$

donde  $O_2$  representa la concentración de oxígeno disuelto medido y  $O_2'$  representa la solubilidad de oxígeno.  $O_2'$  se calculó utilizando un nomograma construido en base a los datos de Green (1965).

## RESULTADOS

La distribución de T°C para enero se muestra en la Figura 4. Los valores son en general más elevados en la boca que hacia el interior de la bahía. El valor mínimo se registró en el extremo interno de Bahía San Quintín y fué de  $12.0^{\circ}\text{C}$  (Estación 1, Figura 2); y el valor máximo se registró en la boca y fué de  $15.7^{\circ}\text{C}$  (Estación 28, Figura 2). La distribución de  $S^{0/00}$  para enero se muestra en la Figura 5. Los valores en general son menores en la boca que hacia el interior de la bahía. El valor máximo se registró en el extremo interno de Bahía San Quintín y fué de  $36.49^{0/00}$  (Estación 1, Figura 2); y el valor mínimo se registró en la boca y fué de  $34.14^{0/00}$  (Estación 28, Figura 2). La distribución del  $O_2$  se muestra en la Figura 6. Contrario a la distribución de T°C y  $S^{0/00}$  (Figuras 4 y 5) no presenta una tendencia a variar monotónicamente de la boca a los brazos, en Bahía Falsa los valores disminuyen hacia el extremo interno; pero en Bahía San Quintín los valores primeramente aumentan de la boca hacia la parte media y luego disminuyen hacia el extremo interno. El valor mínimo se registró en el extremo interno de Bahía Falsa y fué de  $5.15 \text{ ml/l}$  (Estación 16, Figura 2). El valor máximo fué de  $7.73 \text{ ml/l}$  y se registró en la parte media este de Bahía San Quintín (Estación 7, Figura 2). La distribución de pH se muestra en la Figura 7. Es en general muy similar a la distribución de  $O_2$ . El valor mínimo fué de  $8.12$  y se registró, al

igual que el de  $O_2$ , en el extremo interno de Bahía Falsa. El valor máximo fué de  $8.40$  y se registró en la parte media este de Bahía San Quintín (Estaciones 11 y 12, Figura 2). La distribución de alcalinidad se muestra en la Figura 8. Los valores máximos se registraron hacia el interior de la bahía disminuyendo hacia la boca. El valor máximo se registró en el extremo interno de Bahía San Quintín y fué de  $2.54 \text{ meq/l}$  (Estación 1, Figura 2). El valor mínimo fué de  $1.91$  y se registró en el exterior de la boca (Estación 27, Figura 2).

En el viaje de campo de febrero solamente se ocuparon 11 estaciones hidrográficas debido a que las condiciones de mal tiempo no permitieron seguir trabajando; lluvias torrenciales con fuertes vientos que provocaron un oleaje estimado en  $0.5$  metro de altura impidieron el estudio de Bahía Falsa durante el segundo día. Las distribuciones de T°C,  $S^{0/00}$ ,  $O_2$  y pH en Bahía San Quintín para febrero, se muestran en las Figuras 9, 10, 11 y 12. La T°C fué bastante uniforme con una tendencia a aumentar de oeste a este (Figura 9). La  $S^{0/00}$  presenta un gradiente muy marcado disminuyendo desde el interior de la bahía hacia la parte media (Figura 10). El  $O_2$  presenta un gradiente en el sentido longitudinal y en el sentido transversal de la bahía, aumentando del interior hacia la parte media y de oeste a este (Figura 11). El pH muestra una distribución semejante a la de  $O_2$ , aumentando del interior de la bahía hacia la parte media, y disminuyendo de la parte media hacia el exterior (Figura 12).

La distribución de T°C para abril se muestra en la Figura 13. Contrario a la distribución de T°C de enero los valores máximos se registraron hacia el interior de la bahía, disminuyendo hacia la boca; en Bahía Falsa existe un gradiente en sentido transversal disminuyendo de oeste a este, mientras que en Bahía San Quintín el gradiente es en sentido longitudinal, disminuyendo hacia la boca. El valor máximo se registró en la parte media oeste de Bahía Falsa y fué de  $20.3^{\circ}\text{C}$  (Estación 22, Figura 2). El valor mínimo se registró hacia el exterior de la boca y fué de  $14.1^{\circ}\text{C}$  (Estación 26, Figura 2). La distribución de  $S^{0/00}$  para abril se muestra en la Figura 14; es muy similar a la de T°C. El valor máximo se registró en Bahía San Quintín y fué de  $36.74^{0/00}$  (Estación 2, Figura 2). El valor mínimo se registró en la parte exterior de la boca y fué de  $34.42^{0/00}$  (Estación 28, Figura 2). La distribución de  $O_2$  en abril se muestra en la Figura 15. En Bahía San Quintín los valores aumentan del interior hacia la boca, mientras que en Bahía Falsa los valores aumentan de la boca hacia la parte media oeste y luego disminuyen hacia el extremo interno. El valor máximo se registró en Bahía Falsa y fué de  $7.07 \text{ ml/l}$  (Estación 21, Figura 2). El valor mínimo fué de  $4.23 \text{ ml/l}$  y se registró en el extremo interno de Bahía San Quintín (Estación 1, Figura 2).

La distribución de T°C para el mes de mayo se muestra en la Figura 16. Los máximos valores se registraron hacia los extremos internos de la bahía



FIGURA 3. Localización de las estaciones hidrográficas ocupadas en el cuarto muestreo. Los triángulos oscuros indican los lugares donde se realizó el estudio de variación diurna.

disminuyendo paulatinamente hacia la boca. El valor máximo fué de  $18.5^{\circ}\text{C}$  y se registró en el extremo interno de Bahía Falsa (Estación 16, Figura 3). El valor mínimo se registró en la parte exterior de la boca y fué de  $12.8^{\circ}\text{C}$  (Estación 28, Figura 3). La distribución de  $\text{S}^{\circ}/_{00}$  se muestra en la Figura 17. En general fué muy similar a la del mes de abril. El valor máximo se registró en el extremo interno de Bahía San Quintín y fué de  $36.75^{\circ}/_{00}$  (Estación 2, Figura 3). El valor mínimo fué de  $34.27^{\circ}/_{00}$  y se registró en la parte externa de la boca (Estación 28, Figura 3). La distribución de  $\text{O}_2$  se muestra en la Figura 18. En Bahía Falsa los valores disminuyen del extremo interno hacia la boca. En Bahía San Quintín los valores son muy uniformes aumentando solamente en el tercio cercano a la boca, para volver a disminuir hacia la misma. El valor máximo fué de  $6.63\text{ ml/l}$  (Estación 11, Figura 3); el valor mínimo fué de  $3.87\text{ ml/l}$  y se registró en el extremo interno de Bahía San Quintín (Estación 1, Figura 3).

La toma de datos de la variación diurna en la Estación 2 se hizo a unos 8 metros de la orilla, mientras que en la Estación 20 se hizo a 2 metros de ésta. Estas estaciones se localizaron en zonas que se han considerado propicias para maricultivo, además de que son representativas de las condiciones

ambientales extremas dentro de la bahía ya que una se encuentra en zona de aguas someras y con fondo fangoso, mientras que la otra se encuentra en una zona de aguas relativamente profundas con características casi oceánicas.

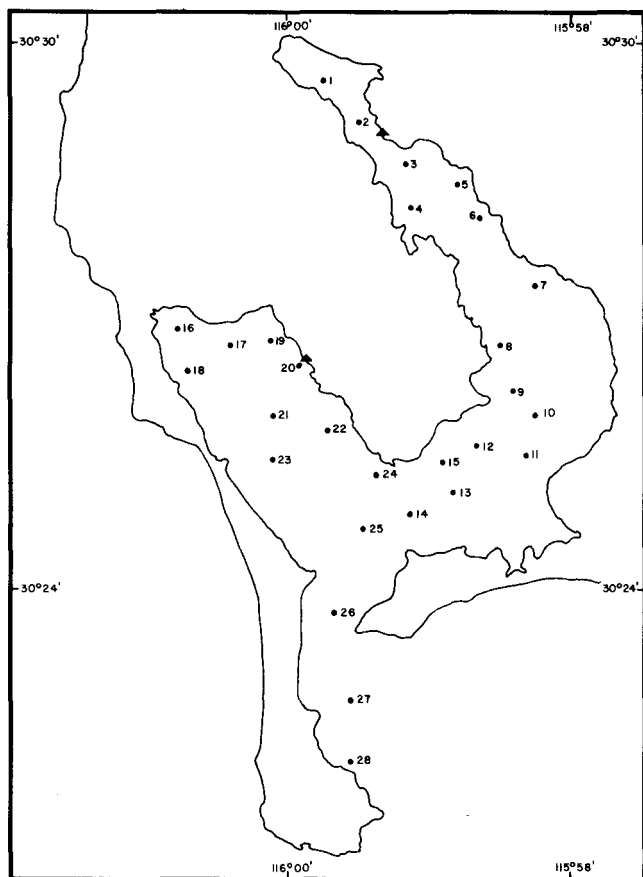
Las variaciones diurnas de  $\text{T}^{\circ}\text{C}$ ,  $\text{S}^{\circ}/_{00}$ ,  $\text{O}_2$ , pH y alcalinidad de la Estación 2, se muestran en las Figuras 19 y 20; y de la Estación 20 se muestran en las Figuras 21 y 22. En la Estación 2 la variación de  $\text{T}^{\circ}\text{C}$  presenta 2 máximos bien marcados de  $18.2^{\circ}\text{C}$  y  $18.6^{\circ}\text{C}$ , correspondiendo a las 20:00–21:00 Hrs. y 15:00 Hrs., respectivamente; y un mínimo de  $16.9^{\circ}\text{C}$  registrado a las 05:00 Hrs. La  $\text{S}^{\circ}/_{00}$  presenta también dos máximos claramente definidos de  $36.35^{\circ}/_{00}$  y  $36.86^{\circ}/_{00}$  registrados a las 01:00 Hrs. y 13:00 Hrs. respectivamente, y dos mínimos de  $35.28^{\circ}/_{00}$  y  $35.40^{\circ}/_{00}$  registrados a las 06:00 Hrs. y 19:00 Hrs. respectivamente. El  $\text{O}_2$  presentó un máximo muy acentuado que fué de  $5.94\text{ ml/l}$  registrado a las 16:00 Hrs. y un mínimo de  $4.45\text{ ml/l}$  registrado a las 08:00 Hrs. El pH presentó un máximo y dos mínimos. El máximo fué de 8.55 a las 16:00 Hrs., y ambos mínimos fueron de 8.45 en los periodos de 24:00 a 02:00 Hrs. y de 12:00 a 14:00 Hrs. La alcalinidad presentó una variación similar a la de  $\text{S}^{\circ}/_{00}$ , con dos máximos y dos mínimos. Los máximos son de  $2.44\text{ meq/l}$  y  $2.48\text{ meq/l}$ , registrados a las 23:00 Hrs., y 13:00 Hrs. respectivamente; y los mínimos de  $2.38\text{ meq/l}$  y  $2.32\text{ meq/l}$ , registrados a las 06:00 y 19:00 Hrs. respectivamente.

En la Estación 20, las variaciones de  $\text{T}^{\circ}\text{C}$ ,  $\text{S}^{\circ}/_{00}$  y  $\text{O}_2$  son muy similares presentando dos máximos y dos mínimos muy acentuados. Para la  $\text{T}^{\circ}\text{C}$ , los máximos son de  $16.5^{\circ}\text{C}$  y  $17.1^{\circ}\text{C}$ , a las 21:00 Hrs. y de las 13:00 a 16:00 Hrs. respectivamente; y los mínimos son de  $15.5^{\circ}\text{C}$  y  $15.8^{\circ}\text{C}$ , registrados a las 05:00 Hrs. y 18:00 Hrs. respectivamente. Los máximos de  $\text{S}^{\circ}/_{00}$  son de  $34.74^{\circ}/_{00}$  y  $34.75^{\circ}/_{00}$  a las 24:00 Hrs. y 13:00 Hrs. respectivamente; y ambos mínimos son de  $34.54^{\circ}/_{00}$ , registrados a las 06:00 Hrs. y 17:00 Hrs. Los máximos de  $\text{O}_2$  son de  $4.85\text{ ml/l}$  y  $5.26\text{ ml/l}$ , a las 24:00 Hrs. y 14:00 Hrs., respectivamente; y el mínimo más acentuado es de  $4.29\text{ ml/l}$ , a las 04:00 Hrs. La variación de pH presentó un máximo muy acentuado que fué de 8.43 a las 22:00 Hrs. y dos mínimos de 8.12 ambos, a las 04:00 Hrs. y 08:00 Hrs. La alcalinidad presentó un máximo y un mínimo. El máximo fué de  $2.34\text{ meq/l}$ , a las 10:00 Hrs.; y el mínimo de  $2.29\text{ meq/l}$ , a las 14:00 Hrs.

## DISCUSIONES

Alvarez y Galindo (1973) mencionan que cuando se hace un estudio hidrográfico como el presente, las gráficas de distribución horizontal de los diferentes parámetros son solamente una primera aproximación a la realidad. Esto es debido a que la toma de datos no es simultánea sino que pueden pasar varias horas entre las primeras y las últimas estaciones, por lo cual la comparación directa entre

los valores tomados en las diferentes estaciones solamente es completamente válida cuando se toman en consideración los cambios que pudieron haber ocurrido durante el tiempo que haya durado el muestreo, debido a los efectos de las mareas, irradiación solar, evaporación, fotosíntesis, etc.

Para el mes de enero la  $T^{\circ}C$  fué más baja en los extremos internos de Bahía Falsa y Bahía San Quintín que en la boca, debido a la influencia de las bajas temperaturas atmosféricas (Figura 4). La temperatura atmosférica mínima en los días de muestreo fué de  $4^{\circ}C$  (Secretaría de Recursos Hidráulicos, Departamento de Hidrometría, oficina en Ensenada). Estas bajas temperaturas afectan mucho más a las aguas someras de la bahía que a las aguas de mar abierto frente a la boca de la misma. La distribución de  $T^{\circ}C$  en febrero se correlaciona con la batimetría, con  $T^{\circ}C$  más bajas en los lugares de mayor profundidad; esto se debe a que el muestreo fué realizado después de medio día y el efecto de irradiación solar se hizo sentir más en las zonas bajas aumentando la  $T^{\circ}C$  (Figuras 2 y 9). Un efecto similar se observó en Bahía San Quintín en enero (Figura 4). En general las  $T^{\circ}C$  fueron más elevadas en febrero que enero.

En cuanto a la distribución de  $T^{\circ}C$  en los meses de primavera (abril y mayo, Figuras 13 y 16) la situación es inversa, con temperaturas mayores hacia los extremos internos de la bahía que en la boca de la

misma. Esto se debe a que la temperatura atmosférica es mayor que la temperatura del agua en estos meses, y el efecto de calentamiento por irradiación solar es mayor en las aguas someras. En Bahía Falsa, la distribución de  $T^{\circ}C$  para el mes de abril muestra un gradiente en sentido transversal opuesto al mostrado en enero (Figuras 4 y 15). Las  $T^{\circ}C$  en abril son mayores en la parte occidental que en la parte oriental de Bahía Falsa. Esto denota de nuevo un claro efecto de la batimetría en la distribución de  $T^{\circ}C$ . Los gradientes longitudinales de  $T^{\circ}C$  en Bahía San Quintín no se muestran muy marcados para los meses de abril y mayo, debido a que el muestreo se realizó durante la pleamar, por lo cual el agua fría del exterior de la bahía había estado expuesta a la irradiación solar en zonas someras solamente un tiempo relativamente corto. Las gráficas de mareas para los períodos en que se realizaron los muestreos en los diferentes meses, se muestran en la Figura 23. En las gráficas 19 y 21 se muestra que la variación diurna de  $T^{\circ}C$  se correlaciona con el estado de las mareas y la hora del día, en una combinación un tanto compleja. En la Estación 2 (Figura 19) se nota en general una mayor correlación de la temperatura con la hora del día que con el estado de la marea, con temperaturas más altas en la tarde (15:00 Hrs.) y con temperaturas más bajas alrededor de las 05:00 Hrs. Una situación semejante se observó en Bahía Falsa.



FIGURA 4. Distribución superficial de temperatura ( $T^{\circ}C$ ) para enero.



FIGURA 5. Distribución superficial de salinidad ( $S^{\circ}/_{00}$ ) para enero.

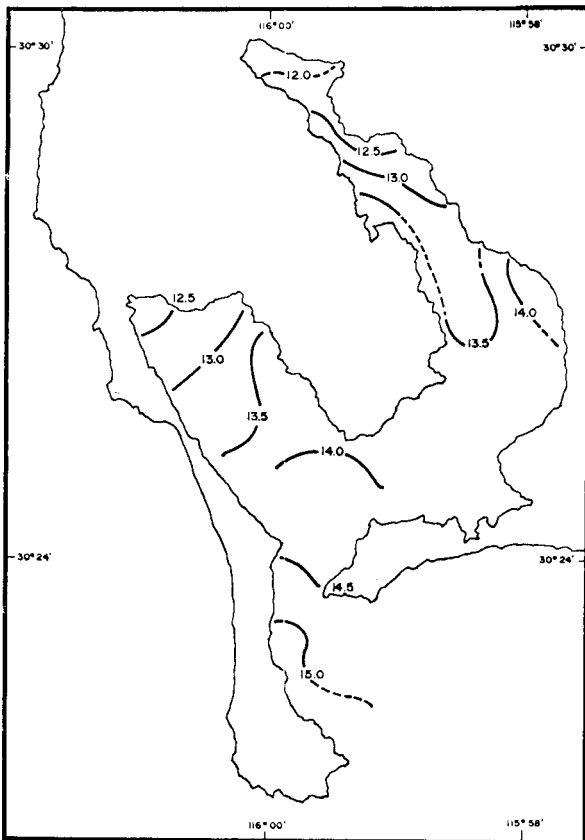

FIGURA 6. Distribución superficial de la concentración de oxígeno disuelto (ml/l) para enero.

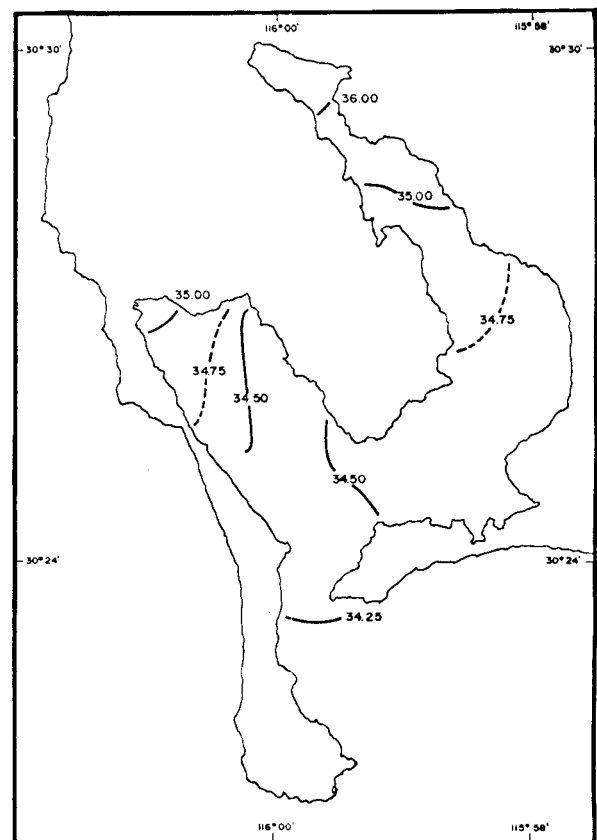

FIGURA 7. Distribución superficial de pH para enero.

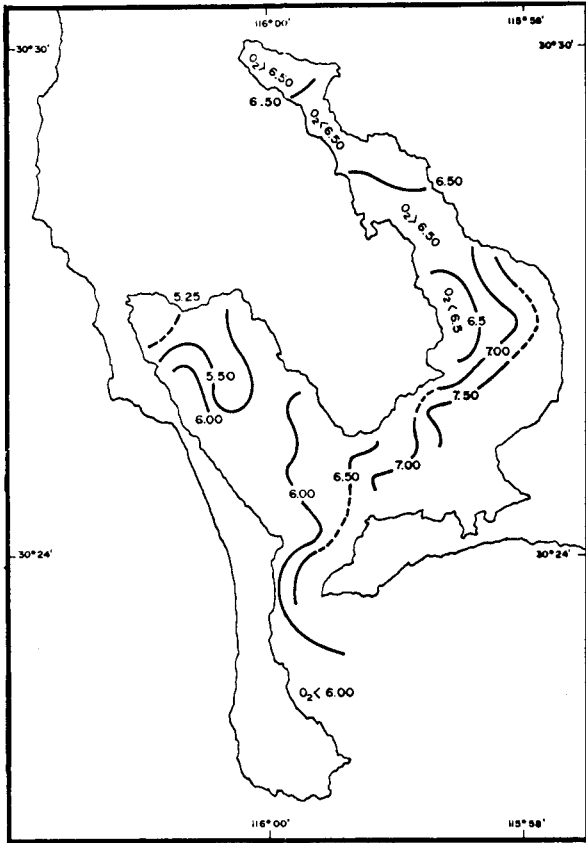

FIGURA 8. Distribución superficial de alcalinidad (meq/l) para enero.

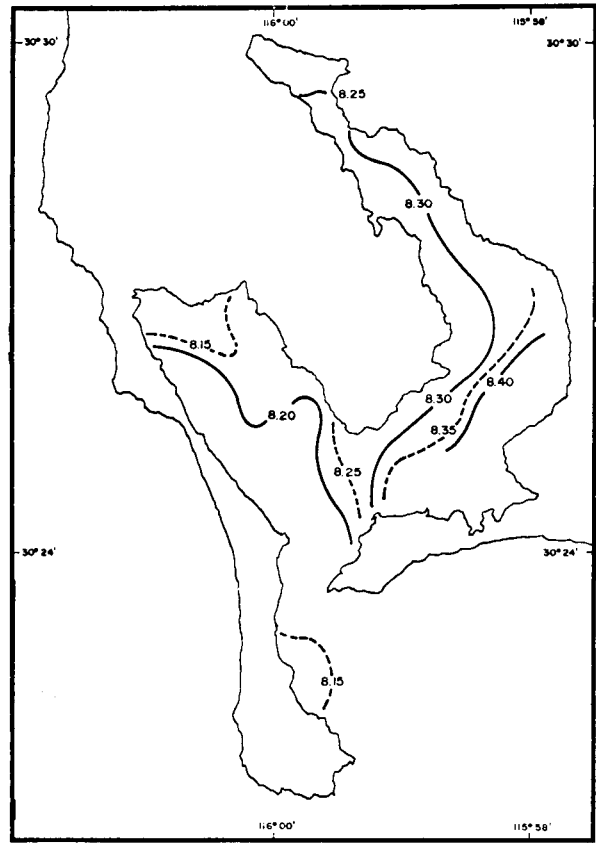

FIGURA 9. Distribución superficial de temperatura (T°C) para febrero.

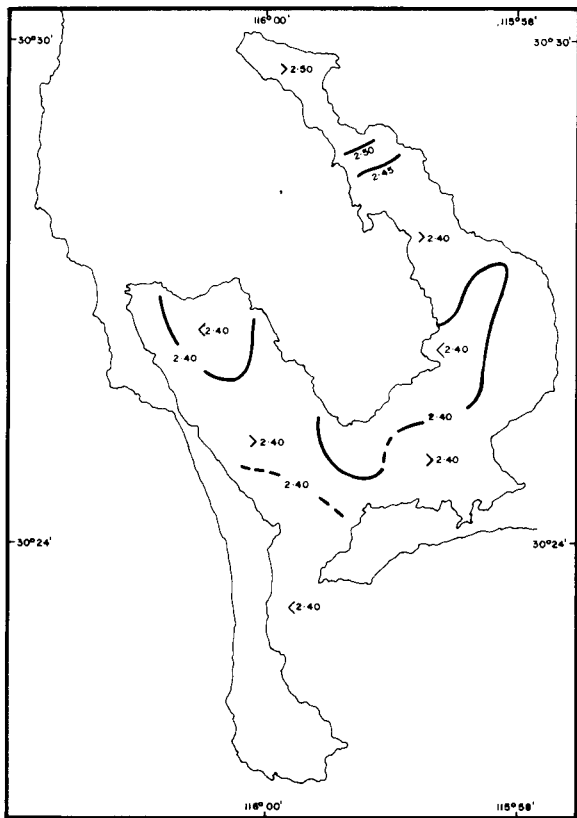

FIGURA 10. Distribución superficial de salinidad ( $S^{\circ}/_{00}$ ) para febrero.

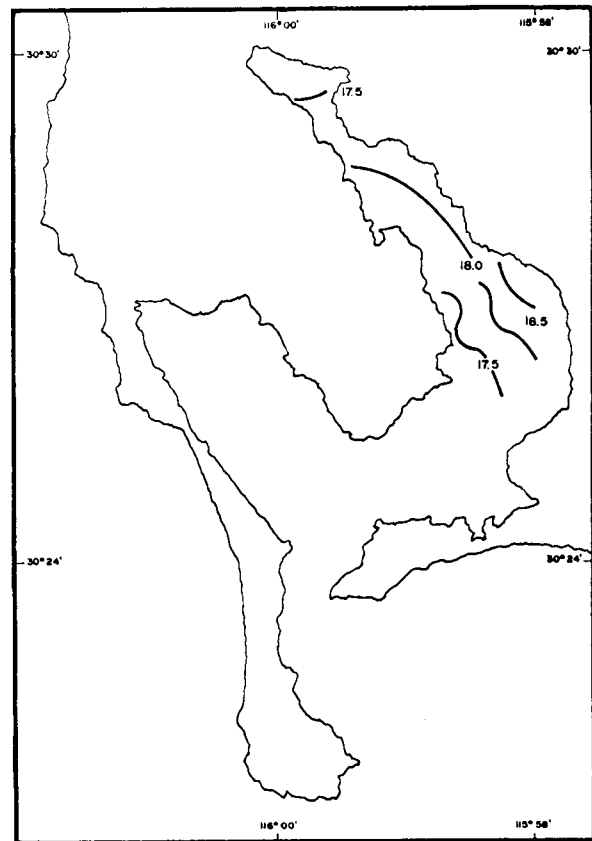

FIGURA 11. Distribución superficial de la concentración de oxígeno disuelto (ml/l) para febrero.

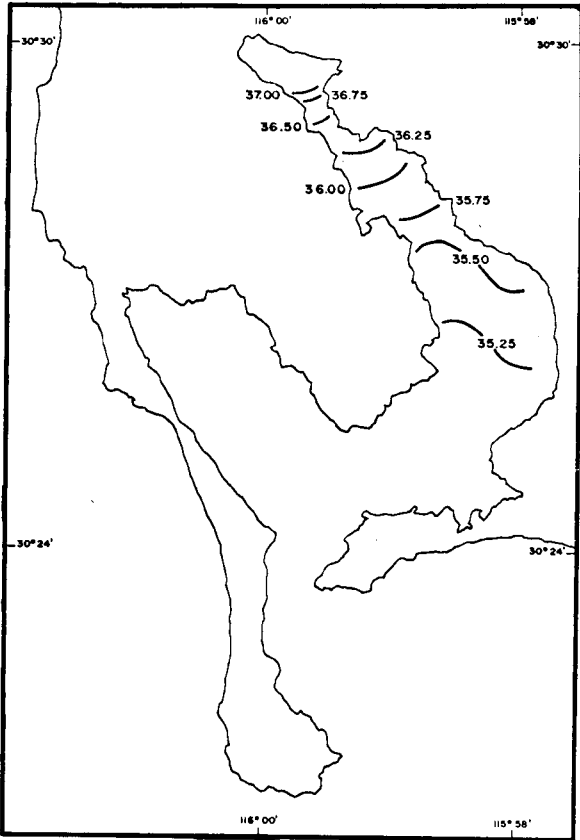

FIGURA 12. Distribución superficial de pH para febrero.

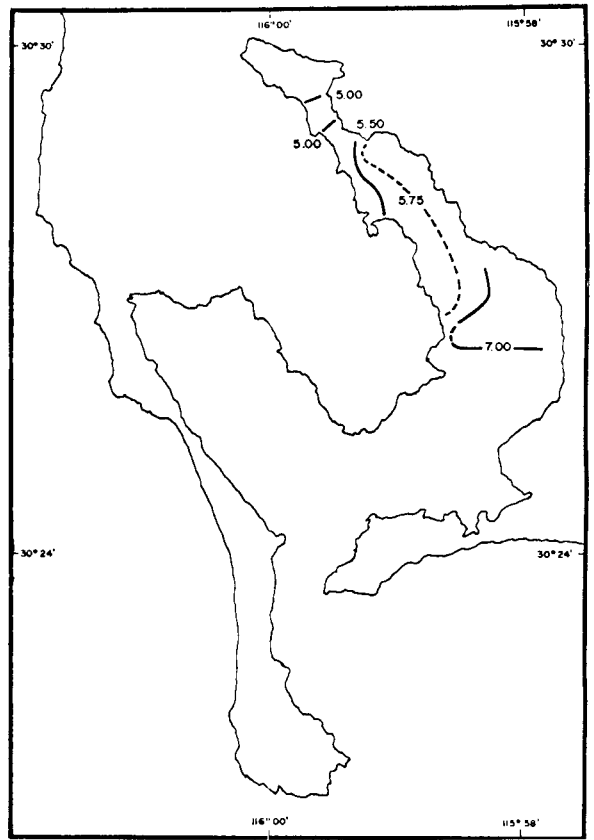

FIGURA 13. Distribución superficial de temperatura ( $T^{\circ}C$ ) para abril.





FIGURA 14. Distribución superficial de salinidad ( $S^{\circ}/_{00}$ ) para abril.

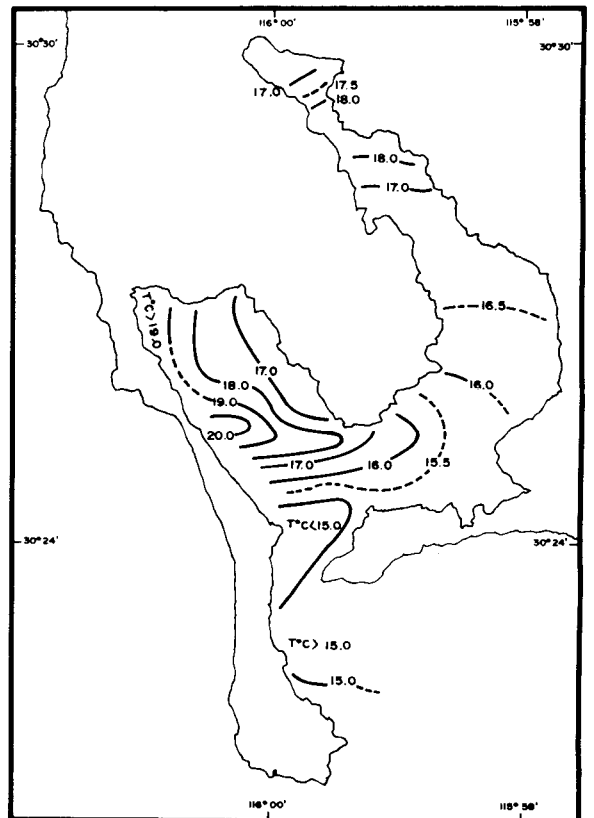

FIGURA 15. Distribución superficial de la concentración de oxígeno disuelto (ml/l) para abril.

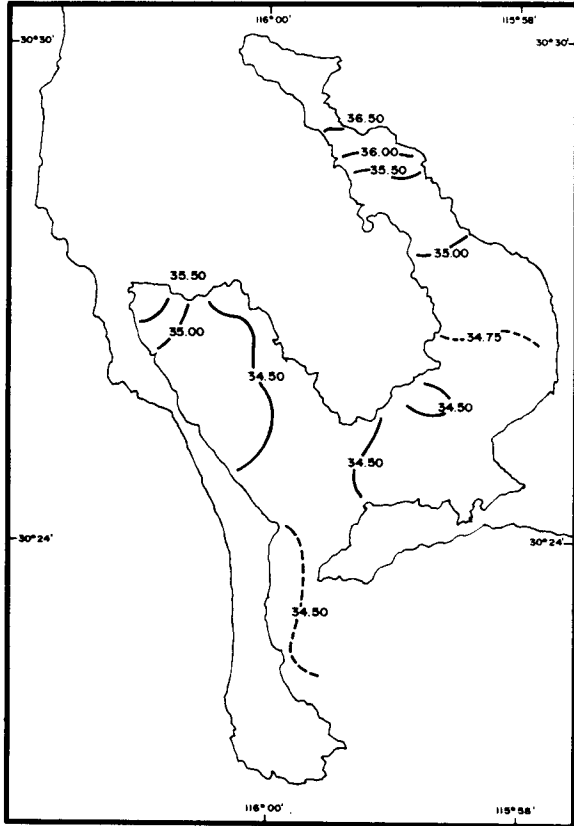

FIGURA 16. Distribución superficial de temperatura ( $T^{\circ}C$ ) para mayo.

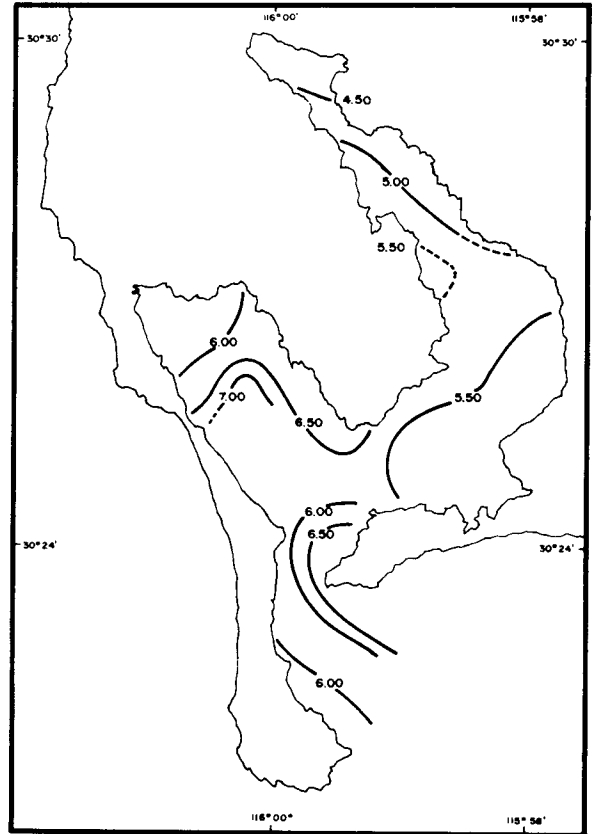

FIGURA 17. Distribución superficial de salinidad ( $S^{\circ}/_{00}$ ) para mayo.

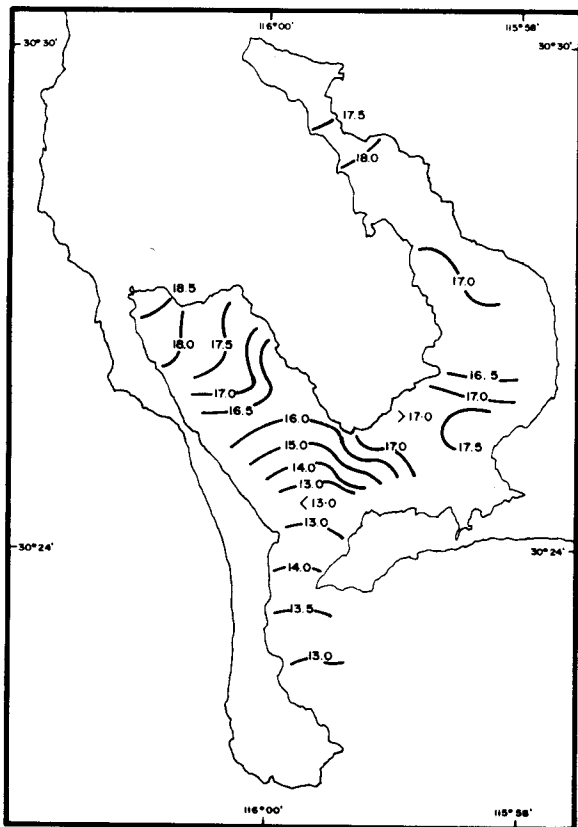

FIGURA 18. Distribución superficial de la concentración de oxígeno disuelto (ml/l) para mayo.

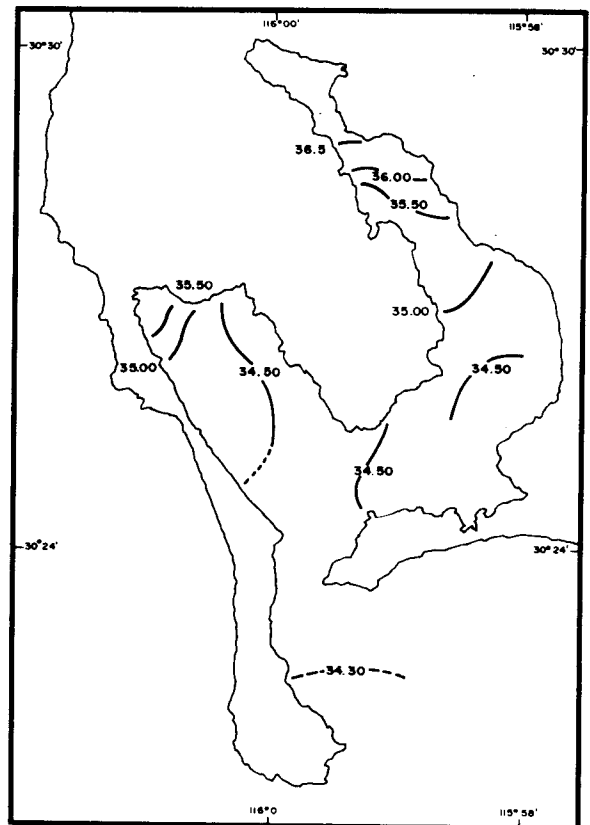

FIGURA 19. Variación diaria de la salinidad ( $S^{\circ}/_{00}$ ), temperatura ( $T^{\circ}C$ ), porcentaje de saturación de oxígeno disuelto (%) y altura de marea, en la Estación 2 (Molino Viejo). La altura de marea corresponde a la boca de la Bahía, sin considerar el retraso de la boca a la Estación 2.

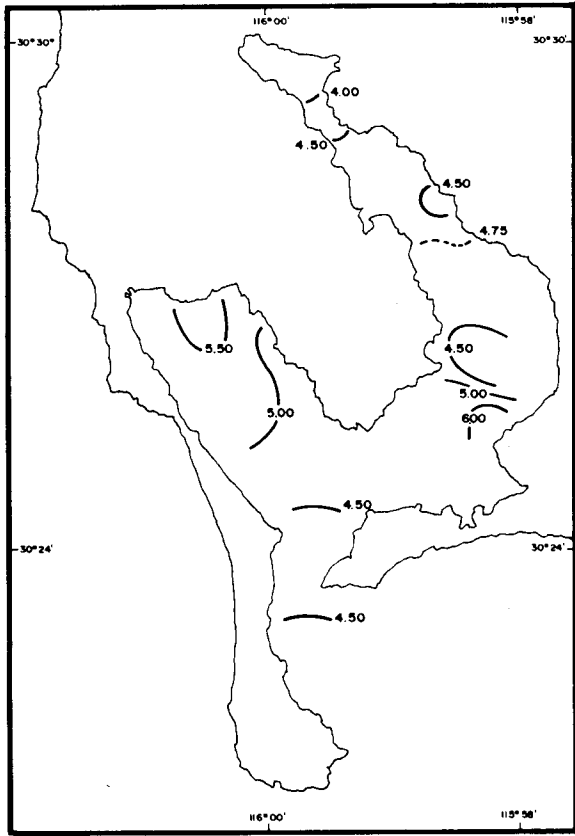

FIGURA 20. Variación diaria de la concentración de oxígeno disuelto (ml/l), pH, alcalinidad (meq/l) y altura de marea, en la Estación 2. La altura de marea corresponde a la boca de la Bahía, sin considerar el retraso de la boca a la Estación 2.

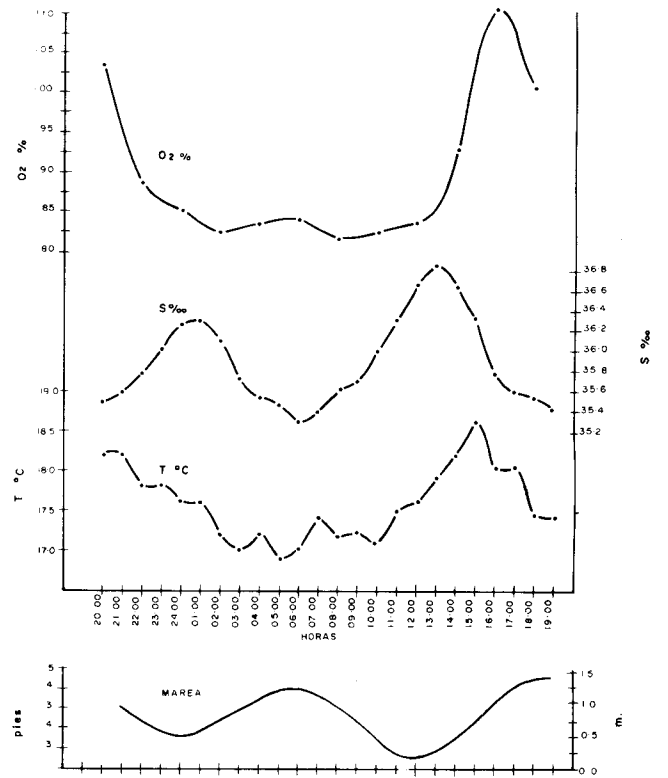

FIGURA 21. Variación diaria de la salinidad ( $S^{\circ}/_{00}$ ), temperatura ( $T^{\circ}C$ ), porcentaje de saturación de oxígeno disuelto (%) y altura de marea, en la Estación 20 (Bahía Falsa). La altura de marea corresponde a la boca de la Bahía, sin considerar el retraso de la boca a la Estación 20.

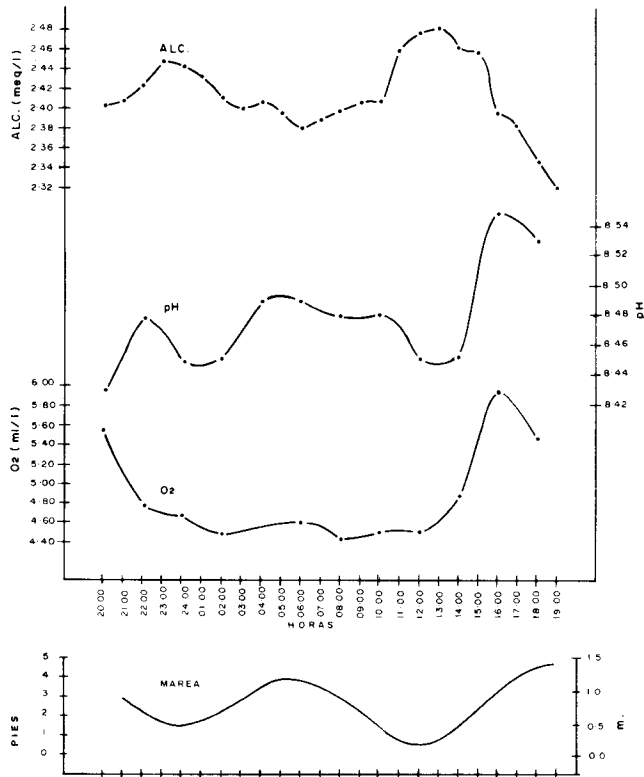

FIGURA 22. Variación diurna de la concentración de oxígeno disuelto (ml/l), pH, alcalinidad y altura de marea, en la Estación 20 (Bahía Falsa). La altura de marea corresponde a la boca de la Bahía, sin considerar el retraso de la boca a la Estación 20.

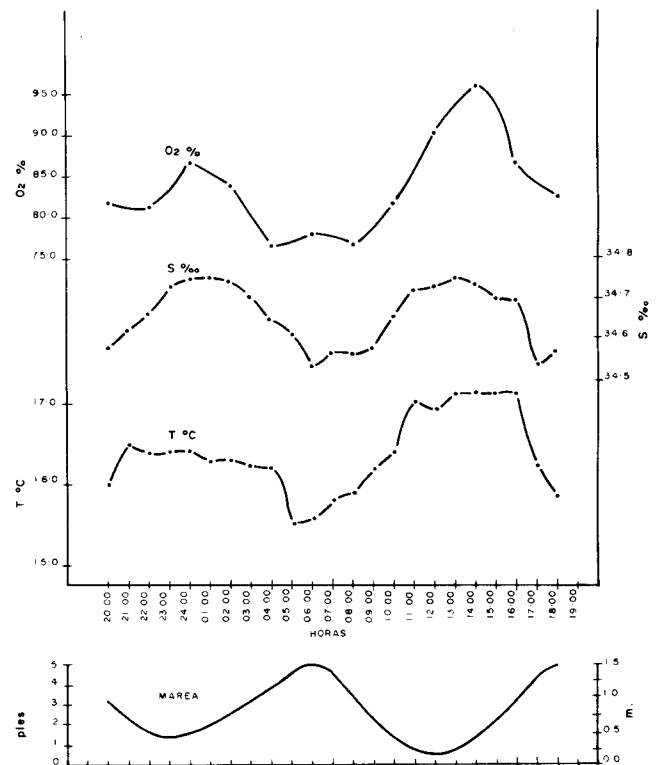

FIGURA 23. Altura de mareas para los periodos en que se realizaron los muestreos. Corresponden a la boca de la Bahía y son tomados del calendario de mareas publicado por la Secretaría de Marina.

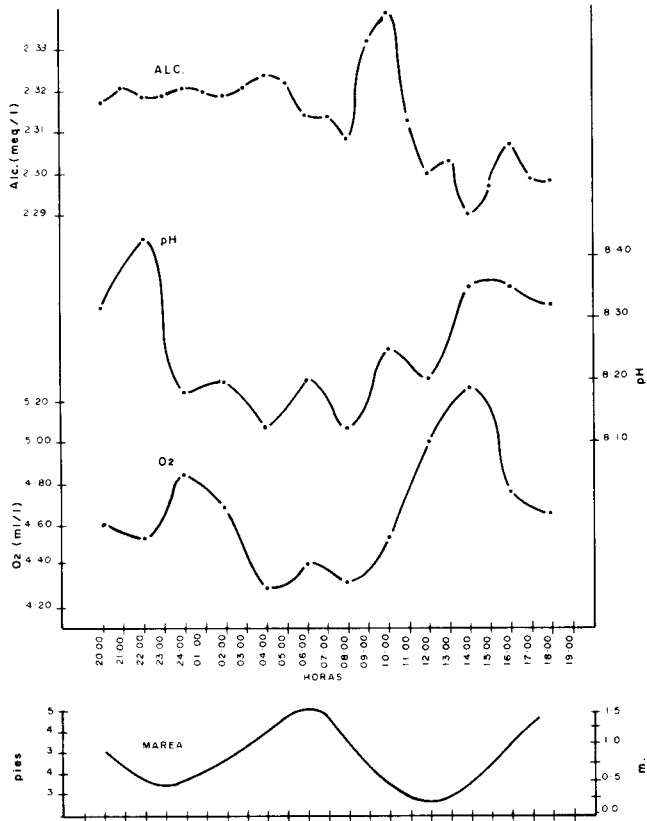

FIGURA 24. Distribución superficial del porcentaje de saturación de oxígeno disuelto (%) para enero.

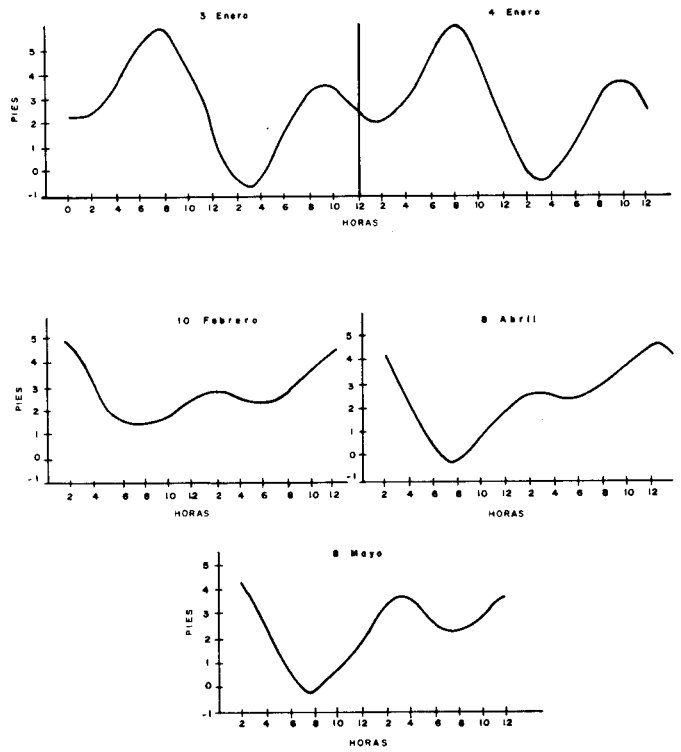

FIGURA 25. Distribución superficial del porcentaje de saturación de oxígeno disuelto (%) para febrero.

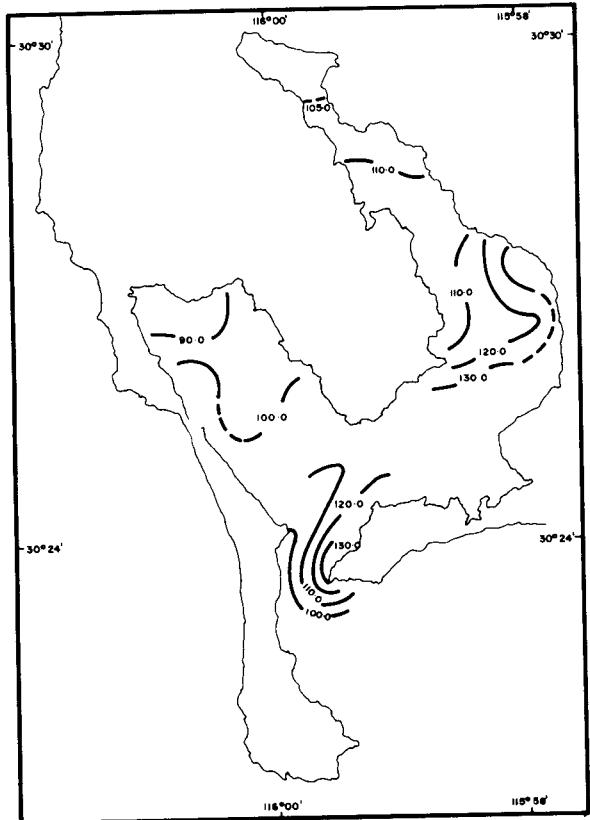

FIGURA 26. Distribución superficial del porcentaje de saturación de oxígeno disuelto (%) para abril.

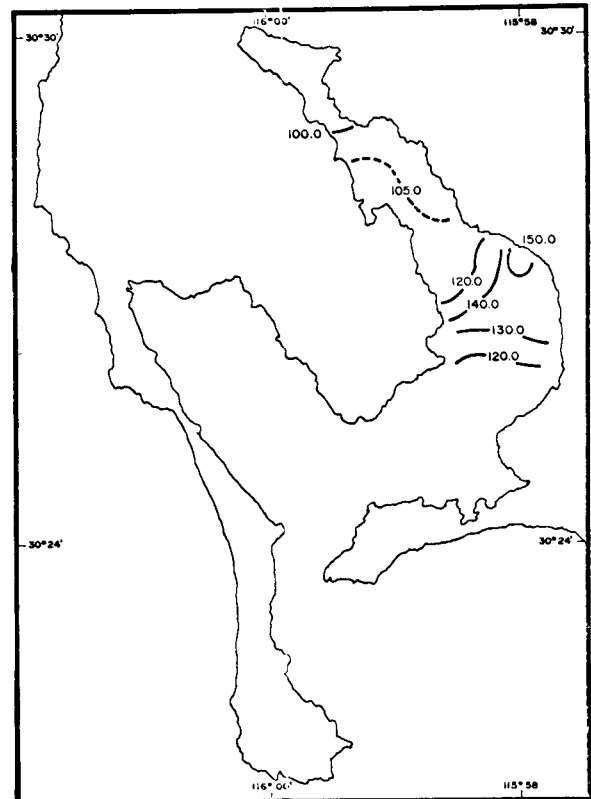

FIGURA 27. Distribución superficial del porcentaje de saturación de oxígeno disuelto (%) para mayo.

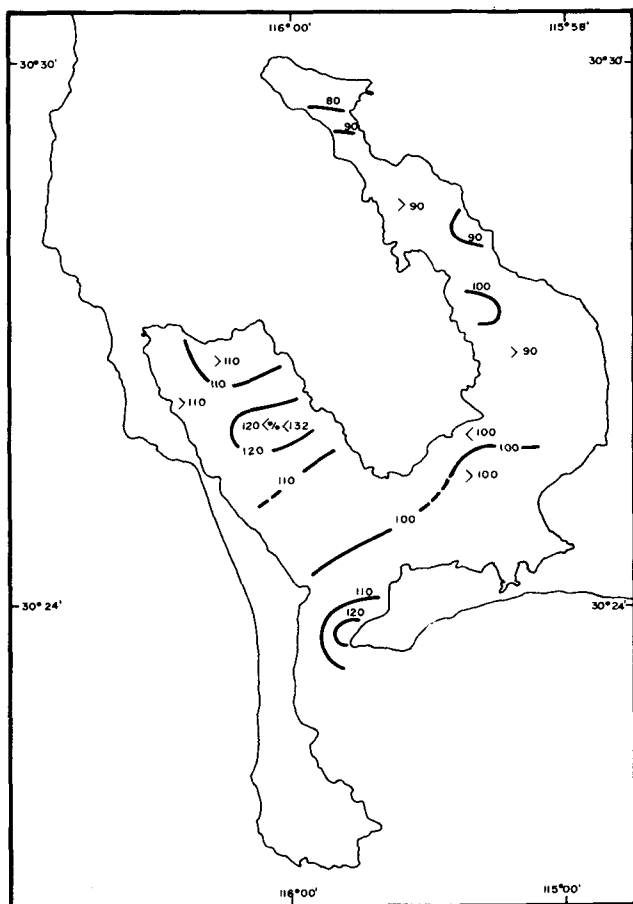

FIGURA 28. pH versus concentración de oxígeno disuelto, durante el estudio de variación diurna. Los círculos abiertos son de la Estación 2, y las cruces son de la Estación 20.

La temperatura superficial de la zona exterior adyacente a la boca fué menor en mayo que en abril y enero (para febrero y marzo no existen datos para esta zona) (Figuras 4, 13, y 16). Esto se debe muy posiblemente al hecho de que en mayo se estaba presentando el fenómeno de surgencia frente a San Quintín; aguas subsuperficiales, más frías, estaban emergiendo hacia la superficie por el efecto de acarreo del viento. De acuerdo con Smith (1968) los vientos que provocan surgencia frente a Baja California son más fuertes en abril y mayo.

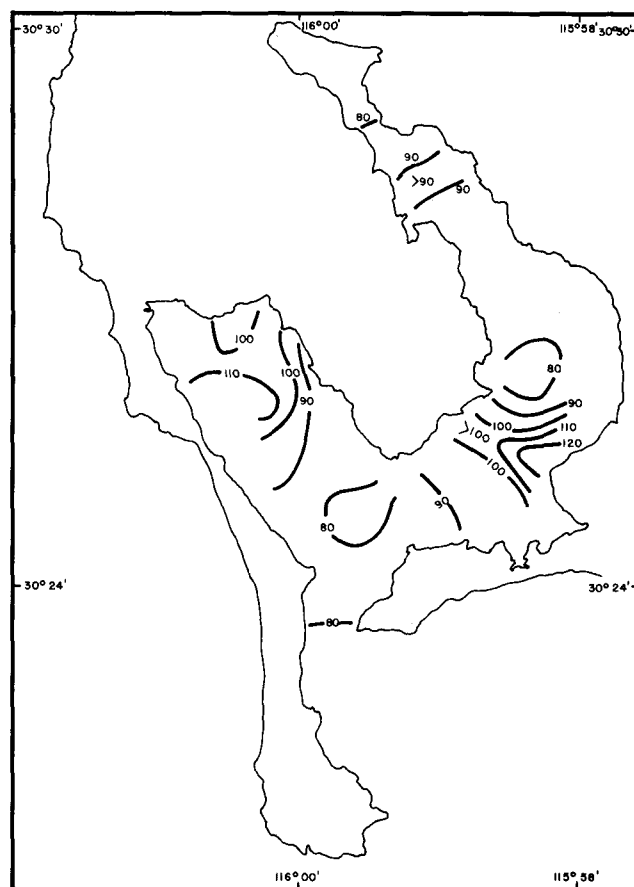
El hecho de que la  $S^0/_{00}$  fuera más elevada hacia los extremos internos de la bahía en todo el periodo de estudio indica claramente que la bahía es un sistema antiestuarino (la evaporación es mayor que la precipitación). Contrario a la  $T^{\circ}C$  la variación diurna de  $S^0/_{00}$  esta correlacionada casi totalmente con el estado de la marea (Figuras 19 y 21), con  $S^0/_{00}$  máximas coincidiendo con la baja marea y  $S^0/_{00}$  mínimas coincidiendo con la alta marea. Este efecto se debe a una evaporación mayor en el interior de la bahía que en el exterior, por el efecto de calentamiento antes mencionado.

La distribución superficial de  $O_2$  durante el periodo de estudio (Figuras 6, 11, 15, y 18) muestra una gran correlación con la de  $T^{\circ}C$ . El  $O_2$  es mayor en invierno que en primavera, debido a la más baja

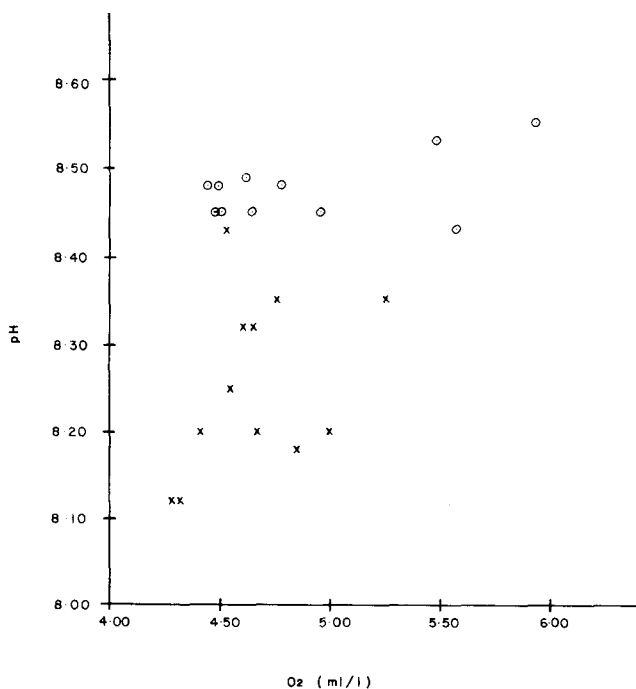
°C, y por ende mayor solubilidad de O<sub>2</sub>, en invierno. Este efecto se nota más claramente en Bahía San Quintín que en Bahía Falsa. La distribución superficial del porcentaje de saturación de oxígeno se muestra en las Figuras 24, 25, 26, y 27.

La distribución de pH se correlaciona estrechamente con la de O<sub>2</sub> (Figuras 6, 7, 11, y 12). Esto indica que los factores que afectan al pH son esencialmente los mismos que afectan al O<sub>2</sub>. En la Figura 28 se puede apreciar una correlación positiva entre la variación diurna de pH y de O<sub>2</sub>; se aprecia además que en la Estación 20 existe una mayor correlación que en la Estación 2, y que para los mismos valores de O<sub>2</sub>, el pH es en general mayor en la Estación 2 que en la Estación 20. Lo anterior posiblemente se deba a que en la Estación 2 el proceso de fotosíntesis sea más intenso que en la Estación 20 y al hecho de que la T°C es mayor en la Estación 2. La fotosíntesis aumenta la concentración de O<sub>2</sub>, y aumenta también el pH debido al consumo de bióxido de carbono. Una intensa fotosíntesis acoplada con un aumento de T°C, debido a la irradiación solar, puede causar un aumento de O<sub>2</sub> y de pH seguido de una disminución de O<sub>2</sub>, por la disminución de la solubilidad de oxígeno y su escape hacia la atmósfera. El intercambio de oxígeno con la atmósfera no afecta el pH. Para corroborar lo anterior se necesitan datos de productividad orgánica primaria en ambas estaciones.

La bahía es un buen ejemplo de un sistema con equilibrio entre los componentes físicos y bióticos. Odum (1971) menciona que este tipo de sistemas tienen una alta productividad biológica. Consisten de varios subsistemas básicos unidos por el flujo de las mareas. Los principales subsistemas son: las zonas bajas de alta productividad orgánica primaria (fotosíntesis); y el subsistema de los canales, en el cual la respiración excede a la fotosíntesis.

Estudios como el presente son considerados muy importantes como punto de referencia para el estudio de bahías adyacentes a zonas densamente pobladas y que han sido fuertemente contaminadas. El estudio de una bahía como la de San Quintín nos da a conocer las condiciones hidrológicas antes de la introducción de contaminantes.

Con relación al desarrollo de maricultivos, aunque no se cuenta todavía con la información de un ciclo anual completo, se pueden obtener algunas conclusiones significativas, por ejemplo, se tenía programado el experimentar en proyectos pilotos, entre otros, a la especie *Crassostrea virginica* (ostión americano), pero Loosanoff (1965) menciona que esta especie no puede desarrollarse en aguas con S<sup>0</sup>/<sub>00</sub> mayor de 30.0<sup>0</sup>/<sub>00</sub>. De acuerdo con nuestros resultados, la S<sup>0</sup>/<sub>00</sub> en San Quintín es persistentemente mayor de 30.0<sup>0</sup>/<sub>00</sub>, por lo cual se descarta la posibilidad de cultivo de *C. virginica*.

De acuerdo con Galtsoff (1964), se puede establecer en general que *Crassostrea virginica*, *C. gigas*, y probablemente *C. angulata* son más

tolerantes a aguas de baja S<sup>0</sup>/<sub>00</sub>; mientras que *Ostrea lurida* y *O. edulis* sobreviven mejor en ambientes con mayor S<sup>0</sup>/<sub>00</sub> y menor turbidez. Por lo anterior se establece que posiblemente las dos especies más indicadas para ser cultivadas en San Quintín sean *O. lurida* y *O. edulis*.

De acuerdo con Sevilla (1959) la temperatura influye fundamentalmente en los procesos reproductivos, nutritivos y en el crecimiento, y que el rango de T°C que los ostiones pueden tolerar es de 10.0°C a 30.0°C, por lo cual la temperatura no es un factor limitante en San Quintín, durante invierno y primavera.

Galtsoff (1964) realizó experimentos para estudiar el efecto del pH en los ostiones y concluyó que tiene un efecto muy pronunciado en la velocidad de consumo de oxígeno.

De acuerdo con Calabrese (1972) para obtener un buen abastecimiento de ostiones, el pH de las aguas no debe ser menor de 6.75 o mayor de 9.00. Por lo anterior se concluye también que el pH no es un factor ecológico limitante durante invierno y primavera para los ostiones, en San Quintín.

## CONCLUSIONES

De acuerdo con los resultados de S<sup>0</sup>/<sub>00</sub>, se descarta la posibilidad de cultivo de *Crassostrea virginica* y se sugieren, como las especies más adecuadas para cultivo, *Ostrea lurida* y *Ostrea edulis*.

En general, las condiciones atmosféricas afectan más las aguas someras de los extremos internos de la bahía que al resto.

La variación diurna de S<sup>0</sup>/<sub>00</sub> está afectada principalmente por el ciclo de mareas; mientras que la variación diurna de T°C está afectada por el ciclo de mareas y por el ciclo diurno de irradiación solar.

## BIBLIOGRAFÍA

- Acosta Ruiz, M. J., and S. Alvarez Borrego. 1974. Distribución superficial de algunos parámetros hidrológicos, físicos y químicos, en el estero de Punta Banda, B.C., en otoño e invierno. *Ciencias Marinas*, 1(1): 16-45.
- Alvarez Borrego, S., and L. A. Galindo Bect. 1974. Hidrología del alto Golfo de California—I. Condiciones durante otoño. *Ciencias Marinas*, 1(1): 46-64.
- Alvarez Borrego, S., and R. Schwartzlose. 1973. Algunos problemas oceanológicos de los mares adyacentes a la Península de Baja California. *CALAFIA*, 2(2): 37-39.
- Barnard, L. 1962. Benthic marine exploration of Bahía de San Quintín, Baja California, 1960-61. *Pac. Nat.*, 3(6): 249-274.
- 1964. Marine amphipoda of Bahía de San Quintín, Baja California. *Pac. Nat.*, 4(3): 55-139.
- 1970. Benthic ecology of Bahía de San Quintín, Baja California. *Smithsonian Contr. Zool.*, (44): 1-60.
- Calabrese, A. 1972. How some pollutants affect embryos and larvae of American oyster and hard shell clam. *Mar. Fish. Rev.*, 34(11-12): 66-77.
- Dawson, E. Y. 1962. Benthic marine exploration of Bahía de San Quintín, Baja California. 1960-61, Marine and Marsh vegetation. *Pac. Nat.*, 3(7): 275-280.
- Galtsoff, P. S. 1964. The American oyster *Crassostrea virginica* Gmelin. U. S. Fish and Wildl. Serv., *Fish. Bull.*, 64: 1-480.

- Gorsline, D. F., and R. A. Stewart. 1962. Benthic marine exploration of Bahía de San Quintín, Baja California, 1960-61. *Marine and Quaternary Geology. Pac. Nat.*, 3(8): 281-319.
- Green, E. J. 1965. A redetermination of the solubility of oxygen in sea water and some thermodynamic implications of the solubility relations. Ph.D. Thesis. Massachusetts Institute Technology, Cambridge, 136 p.
- Keen, A. M. 1962. A new west Mexican subgenus and new species of Montacutidae (Mollusca: Pelecypoda), with a list of Mollusca from Bahía de San Quintín. *Pac. Nat.*, 3(9): 321-328.
- Loosanoff, V. L. 1965. The American or Eastern oyster. U. S. Bur. Com. Fish., Fish and Wildl. Serv., Circ. 205: 1-35.
- Menzies, R. J. 1962. The marine isopod fauna of Bahía de San Quintín, Baja California, Mexico. *Pac. Nat.*, 3(11): 337-348.
- Odum, E. P. 1971. *Fundamentals of Ecology*. W. B. Saunders Co. Phila. 574 p.
- Reish, D. J. 1963. A quantitative study of the benthic polychaetous annelids of Bahía de San Quintín, Baja California. *Pac. Nat.*, 3(14): 397-436.
- Secretaría de Recursos Hidráulicos. Departamento de Hidrometría Oficina de Ensenada. Datos Climatológicos (no publicados).
- Sevilla, M. L. 1959. Datos biológicos para el cultivo de ostión de Guaymas, Son. SIC., Dir. General de Pesca e Ind. Conexas.
- Smith, R. L. 1968. Upwelling. *Oceanogr. Mar. Biol. Ann. Rev.*, 6: 11-46.
- Strickland, H. D., and T. R. Parsons. 1965. A practical handbook of sea water analysis. *Fish. Res. Bd. Canada, Bull.*, (167): 1-311.

# CONCENTRACIÓN DE DDT Y SUS METABOLITOS EN ESPECIES FILTROALIMENTADORES Y SEDIMENTOS EN EL VALLE DE MEXICALI Y ALTO GOLFO DE CALIFORNIA

J. GUARDADO PUENTES

Escuela Superior de Ciencias Marinas  
Universidad Autónoma de Baja California  
Ensenada, Baja California

## ABSTRACT

High concentrations of DDT and its natural breakdown derivatives were found in clams, Veneridae; *Corbicula* sp., in irrigation channels of the Mexicali Valley. These concentrations increase as the sampling area approaches the mouth of the Colorado River. This observation suggests that the agricultural area of the Mexicali Valley is an important source of organochloride pollution for the Northern Gulf of California. This is an area in which many commercially and ecologically important species are found, such as shrimp, *Panaeus* sp., and, at least until very recently, the Totoaba, *Cynoscion macdonaldi*.

The concentrations of organochlorides in the Northern Gulf of California were also obtained for the clam *Chione* sp. and these were found to be somewhat lower. Lower concentrations of DDT and its natural breakdown derivatives were also found in the region of the mouth of the Colorado River. This is probably caused by the particular oceanographic conditions which include currents, turbidity, and sedimentation rates; these might combine to reduce the organochloride levels in the area, but may also carry some pollutants into the Gulf, south of the study area.

## INTRODUCCIÓN

El presente estudio fué realizado en la Unidad de Ciencias Marinas, dependiente de la Universidad Autónoma de Baja California y formó parte de un estudio Oceanológico auspiciado bajo contrato por la Secretaría de Recursos Hidráulicos.

Se ha demostrado en experimentos de laboratorio que el DDT afecta el desarrollo, la reproducción y la mortalidad de gran cantidad de especies en concentraciones que existen comunmente en los medios ambientales marinos cercanos a las costas (SCEP, 1973); aún considerando que las interacciones de todos los componentes del ecosistema marino pueden hacer variar notablemente esas concentraciones, se evidente que constituyen un factor importante que puede ser decisivo para el equilibrio ecológico de zonas como la del alto Golfo de California, a donde se tiene la certeza de que se están incorporando cantidades

considerables de insecticidas (Nishikawa y otros, 1971) y que en los últimos años se ha observado un decremento en su potencial biológico-pesquero (Avalos, 1974). Esta situación ha planteado una problemática, la cual solo será posible resolver a través de un estudio interdisciplinario en el cual queden incluidos todos los aspectos de la misma.

Para la primera parte de este estudio se ha tomado como punto de partida la contaminación ambiental causada por los insecticidas organoclorados que son aplicados en los valles agrícolas de Mexicali, Sonora y Sinaloa. Se supone que los medios de transporte de estos contaminantes al área del alto Golfo de California, son principalmente los vientos y las corrientes marinas. Woodwell (1967) demostró que solo el 50% del DDT total que es aplicado por medios aéreos cumple con su misión, quedando adherido el resto a las hojas de las plantas o incorporándose al sustrato, y el 50% restante queda en la atmósfera en forma de vapor o adherido a partículas para ser transportado por el viento hasta ser precipitado por acción de las lluvias. Los insecticidas que quedan sobre el sustrato, son transportados por los escurrimientos de agua hacia los ríos o a los drenes para llegar generalmente al mar, en donde se incorporan a los organismos marinos afectando fundamentalmente las reacciones enzimáticas del metabolismo y por ende su fisiología, redundando evidentemente en el equilibrio ecológico de la zona.

El trabajo se ha dividido en dos zonas, la primera cubre todos los canales del sistema de riego del Valle de Mexicali, el cual presenta una forma irregular teniendo sus límites al norte con la frontera de Estados Unidos de América; al sur con el Golfo de California; al este con el Desierto de Sonora, y al oeste con la Laguna Salada. Hacia la parte noroeste y suroeste se encuentra limitado por dos grandes cadenas montañosas, las cuales pueden constituir una barrera natural para el transporte de estos contaminantes hacia otros lugares (Figura 1). La segunda zona se encuentra localizada en el extremo norte del Golfo de California, en lo que fué la desembocadura del Río Colorado. En esta zona se han distribuido dos estaciones, una situada al extremo sur de la Isla Montague y la otra sobre la costa del norte de San Felipe, B.C. (Figuras 1 y 7).

La figura número uno comprende ambas zonas, y están enmarcadas con la siguiente localización geográfica:

Vértice	Longitud	Latitud
NE	114° 43'	32° 14'
NW	115° 30'	32° 12'
SE	114° 34'	31° 39'
SW	115° 08'	31° 38'

Otra parte de esta investigación la constituyen las concentraciones de hidrocarburos clorados en sedimentos de ambas zonas.

De los insecticidas aplicados en la zona agrícola del Valle de Mexicali, el DDT constituye aproximadamente el 50% debido a su gran eficiencia y a su bajo costo. De 1971 a 1973 se aplicaron en el Valle de Mexicali 900 toneladas de DDT y formulaciones conteniéndolo (Nishikawa y otros, 1971). Los compuestos organoclorados a los cuales pertenece el DDT, son de los insecticidas que causan mayores problemas residuales, ya que su tiempo de degradación a compuestos menos tóxicos es prolongado. De acuerdo con Macek (1969) la persistencia de organoclorados en algunos peces puede observarse en el cuadro siguiente:

Insecticida	Persistencia
DDT	5 meses
DDD	6 meses
Toxafeno	6 meses
Dieldrina	1 mes
Heptacloro	1 mes

Estos valores solo pueden formarse como referencia, ya que fueron determinados bajo condiciones controladas y es lógico suponer que los diversos factores ambientales, pueden hacerlos variar notablemente. La acumulación de DDT en el agua es casi insignificante dado que es prácticamente insoluble en ella (0.1 ppb), en cambio en los animales, la acumulación y su persistencia es mucho mayor, ya que se solubiliza fácilmente en los tejidos grasos en donde puede ser retenido por un tiempo largo aún no determinado (Nishikawa y otros, 1971). La sintomatología que presentan los insectos al intoxicarse con DDT, es la siguiente: primeramente, el animal pasa por una fase de excitación nerviosa y convulsiones violentas, esta fase va disminuyendo en intensidad hasta que se produce la incoordinación motriz, en estas condiciones el insecto queda inmobilizado y así vive dos o más horas hasta que muere (Nishikawa y otros, 1971), evidentemente estos síntomas denotan una clásica intoxicación del sistema nervioso, a nivel bioquímico-fisiológico, lo que ocurre es lo siguiente: los estímulos externos se transmiten de un punto del cuerpo a otro a través de un cambio en la concentración de iones en los nervios, el estímulo es transportado más allá de la neurona o célula receptora en forma de acetil-colina la cual se difunde produciendo la respuesta al estímulo; una vez que la acetil-colina ha provocado la respuesta

correspondiente, ha de ser eliminada para que el receptor pueda restablecerse para un estímulo futuro, o para evitar respuestas incontroladas de un mismo estímulo; la eliminación de la acetil-colina, se efectúa por hidrólisis del compuesto, esta reacción bioquímica está catalizada por la acetil-colinesterasa, en organismos contaminados con DDT esta enzima es inhibida y el órgano receptor no podrá restablecerse, originando convulsiones, parálisis y finalmente la muerte (McGilvery, 1970).

La ATP-asa de las biomembranas es una enzima que proporciona energía para el transporte de iones como  $Ca^{+}$ ,  $Na^{+}$  y  $K^{+}$  a través de la membrana celular (Skou, 1965), el DDT inhibe esta enzima bloqueando el transporte iónico y a esto se puede deber el adelgazamiento del cascarón de los huevos de algunas aves y la conducta anormal observada en poblaciones que han sido contaminadas por él. Se ha encontrado que la presencia del DDE (Metabolito del DDT) inhibe a la anhidrasa carbónica (Bitman, Cecil, Fries, 1970) siendo esta enzima indispensable para la depositación del carbonato del calcio en los cascarones de los huevos y para el mantenimiento de un gradiente de pH a través de las membranas celulares (SCEP, 1973).

El DDE induce enzimas oxidasas de funciones mixtas que hidroxilan y producen compuestos solubles en agua, las hormonas esteroides tales como estrógeno, testosterona (Coney, 1967; Peakall, 1970) y tiroxina (Schwartz, 1969) son metabolizadas a mayor velocidad cuando estas enzimas son inducidas; experimentos de laboratorio muestran concentraciones muy bajas de estrógeno en pichones contaminados con DDE (SCEP, 1973).

Así, en base a lo expuesto anteriormente, el objetivo del presente trabajo es el de contribuir con información al mejor conocimiento del problema que constituye la contaminación por insecticidas en la zona del alto Golfo de California, para que en futuro se tengan elementos suficientes para tratar de evitar que adquiera proporciones ecológicamente desastrosas. También se pretende buscar una relación entre las concentraciones de DDT y las variaciones de abundancia que de hecho han sufrido los recursos pesqueros más importantes de la región (camarón y totoaba). Asimismo, mediante una interpretación de los resultados obtenidos se tratará de establecer un sistema de circulación general de pesticidas en las dos zonas de interés.

## MATERIAL Y MÉTODOS

En la zona localizada en el Valle de Mexicali se efectuaron tres muestreos (febrero, julio, y septiembre de 1973), con el fin de apreciar la variación temporal de insecticidas en el ambiente. Para la elaboración de la red de estaciones, dicha zona se dividió en tres partes bien definidas (Figura 1): La primera, localizada al este, representada en su mayor parte por el curso del Río Colorado, sobre el





TABLE 1  
Concentraciones promedio de metabolitos del DDT en PPM.

No. estación	opDDE	ppDDE	ppDDD	ppDDT	No. muestrás	Valor mfnimo	Valor promedio	Valor máximo
1	0.10	0.33	0.11	0.02	10	0.18	0.64	1.41
2	0.06	0.38	0.14	0.15	10	0.15	0.73	1.43
3	0.27	0.41	0.37	0.13	10	0.52	1.06	1.66
4	0.23	0.50	0.26	0.08	10	0.57	1.15	2.49
5	0.03	1.25	0.41	0.31	10	0.91	1.99	4.30
6	0.13	2.06	1.05	0.20	10	1.19	3.48	6.13
7	0.35	2.79	2.70	0.17	10	4.48	5.65	8.93
8	0.22	2.44	2.00	1.35	10	5.60	6.29	13.26
9	0.17	3.68	5.26	1.65	10	4.27	14.08	24.77

de cada uno de los metabolitos así como el total de DDT en los organismos colectados. En las almejas de la estación número uno se detectó un promedio de 67.05 ppb de DDT (en este caso, el total de DDT se reporta como la suma de opDDE, ppDDE, ppDDD, opDDD, opDDT, y ppDDT, todos ellos metabolitos del compuesto), asimismo, puede apreciarse que en la estación número dos de la misma zona se encontró un promedio de 145.05 ppb de DDT. La localización de las estaciones en la zona marina en que fueron muestreados los sedimentos se observa en las Figuras 5 y 6, las cuales también muestran las proporciones relativas de cada metabolito del DDT, encontrándose que en la mayor parte de las estaciones el predominante fué el ppDDT.

Los resultados de los análisis en sedimentos se exponen a continuación en el Tabla 2.

DISCUSIONES

Como puede apreciarse en los resultados, las concentraciones de insecticidas en el Valle de Mexicali no se apegan a un patrón definido en su distribución; sin embargo, es notable que las más altas concentraciones de ellos se encuentran hacia la parte sur de la zona agrícola (Figura 1 y cuadro B). Este comportamiento se ha atribuido a varias razones, la primera de ellas a la posición que ocupa cada área muestreada dentro de la zona, pues la intensidad de aplicación de insecticidas es variable



FIGURA 2. Concentración de metabolitos y total de DDT en estaciones 1, 2, 3, y 4 de la zona del Valle de Mexicali.



FIGURA 3. Concentración de metabolitos y total de DDT en estaciones 5, 6, 7, y 8 de la zona de Valle de Mexicali.

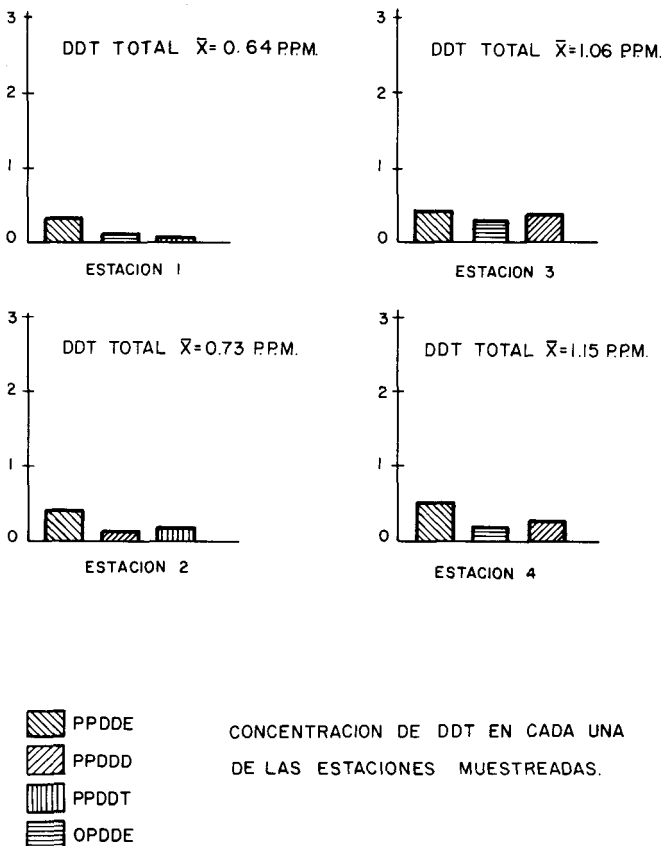

FIGURA 4. Concentración de metabolitos y total de DDT en estación 9 de la zona del Valle de Mexicali.

en cada área. Otra causa de esto pueden ser los vientos dominantes que se observan en la región la mayor parte del año con dirección noroeste-sureste (Alvarez, 1971). En base a lo anteriormente dicho podemos explicarnos las bajas concentraciones que se han encontrado en las áreas que rodean a las Estaciones 1, 2, 3, y 4, los cuales se localizan al noroeste de la zona; al norte de las mencionadas estaciones se extiende una red de montañas que las cubre, aproximadamente con dirección este-oeste, lo

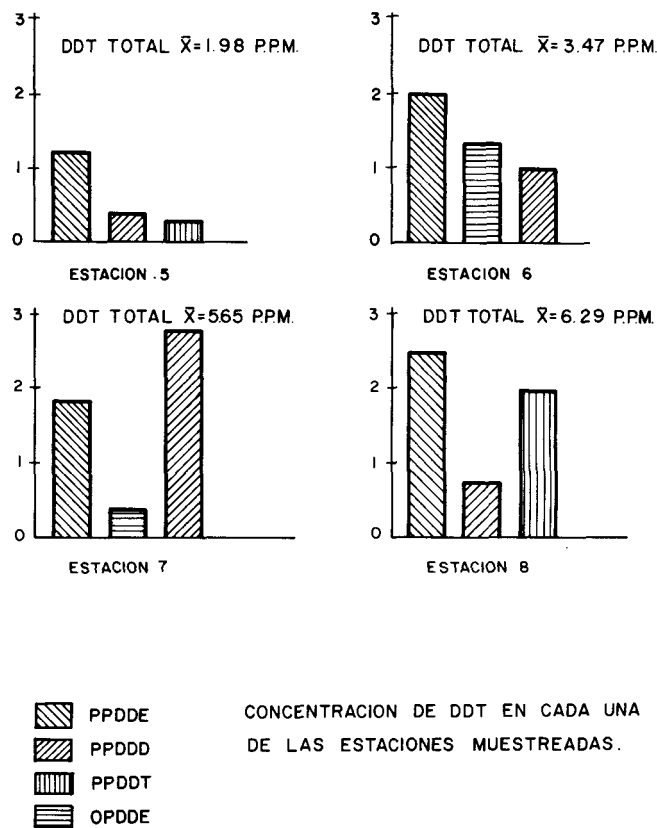

FIGURA 5. Concentración relativa de metabolitos del DDT en el lecho marino del extremo norte del Golfo de California.

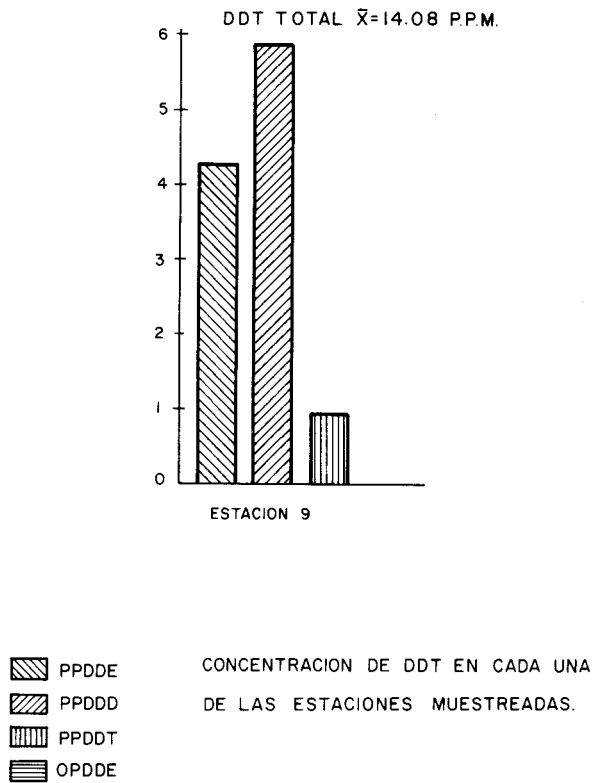
cual constituye una barrera natural para el transporte de estos contaminantes hacia ellas. Las áreas que rodean a las Estaciones 5, 6, y 7 se caracterizan por una actividad agrícola de regular intensidad con respecto al área central donde la aplicación de insecticidas es mucho mayor. Las altas concentraciones encontradas en las Estaciones 8 y 9 se han atribuido al acarreo eólico de insecticidas de la parte norte de las mismas en donde se encuentran las mayores áreas de cultivo.

TABLA 2  
Concentración de organoclorados en sedimentos del extremo norte del Golfo de California en ppb.

No. muestrá	opDDE	ppDDE	ppDDD	ppDDT	DDT total
1 D1		5.48 25%	4.93 22%	11.74 53%	22.15
2 D3		1.71 25%	1.41 20%	3.82 55%	6.94
3 D4		1.32 20%	1.09 16%	4.23 64%	6.64
4 D5	2.55 25%	3.67 36%	1.45 14%	2.55 25%	10.18
5 D6		2.28 45%	0.91 18%	1.91 37%	5.10
6 D7		49.86 41%	43.07 35%	29.41 24%	122.34
7 D8	5.88 34%	2.50 14%	2.42 14%	6.48 38%	17.28
8 C1		2.70 30%	2.24 25%	3.96 45%	8.90
9 C2		1.90 25%	1.37 18%	4.08 55%	7.35
10 C3		3.02 30%	1.47 14%	5.33 54%	9.83
11 C5	15.4 98%	0.30 2%			15.70
12 C6	3.72 4%	23.75 29%	20.69 25%	32.65 40%	80.81
13 C8	5.85 36%	3.25 20%	3.32 21%	3.61 23%	16.03
14 E3	5.93 54%	1.55 14%	0.98 9%	2.54 23%	11.00
15 E5	8.32 53%	1.45 9%	2.02 13%	3.64 23%	15.43

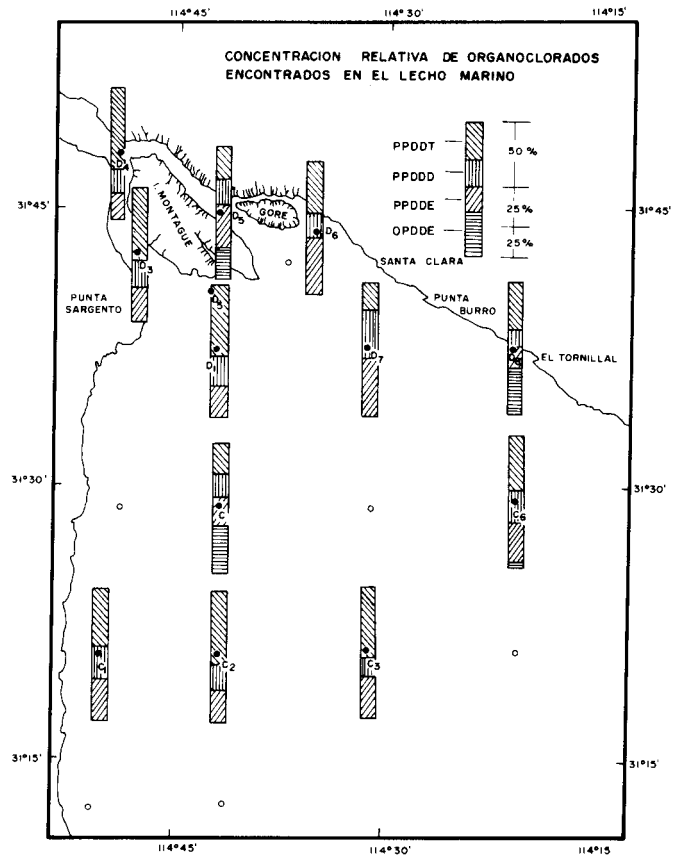

FIGURA 6. Concentración de metabolitos del DDT en el lecho marino del extremo norte del Golfo de California.



FIGURA 7. Localización de los muestreos de almejas en la zona.

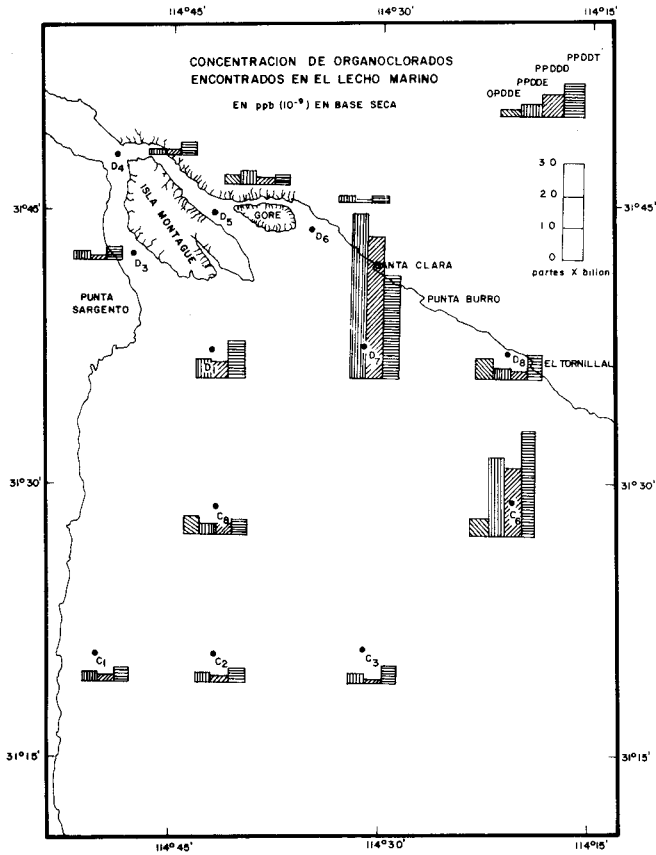

FIGURA 8. Concentraciones promedio de metabolitos y DDT total en las dos estaciones de la zona marina y comparación del DDT total en las dos estaciones.

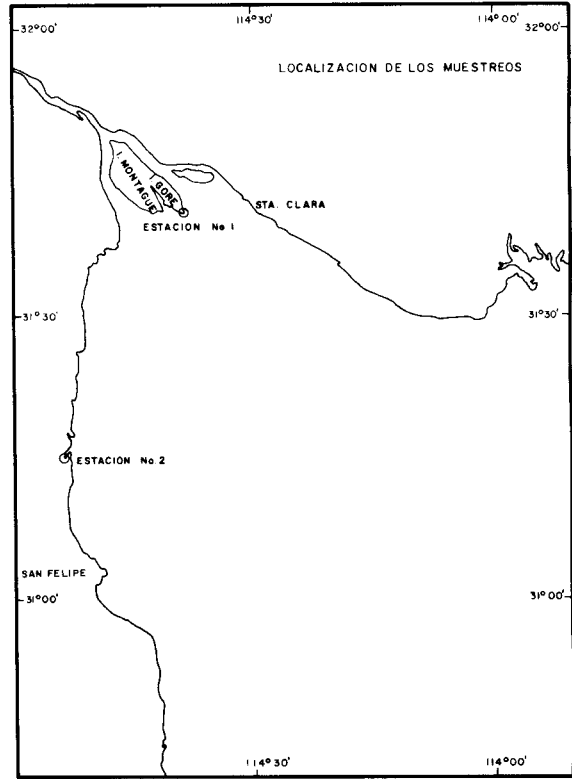

FIGURA 9. Concentración relativa de metabolitos y DDT total en las dos estaciones de la zona marina.

Respecto a los resultados obtenidos en las almejas de la zona marina, consideramos importante el hecho de haber encontrado un promedio de DDT considerablemente mayor en la estación número dos, a pesar de encontrarse ésta mucho más distante geográficamente de pesticidas respecto a la estación número uno de la misma zona. Esto puede deberse a dos posibles factores; el primero: que haya un giro de corrientes en sentido contrario al de las manecillas del reloj, lo cual haría que los contaminantes que provengan del Delta del Río Colorado, acarreados por las aguas, lleguen primero a la zona costera de Baja California para llegar a la zona costera de Sonora solo después de haber recorrido una larga distancia, incorporándose en parte a organismos, a materiales en suspensión o depositándose en el lecho marino. Esta posibilidad va de acuerdo Thompson (1969) quien encontró indicios de este tipo de circulación en base a mediciones de corrientes, distribución de sedimentos, turbidez y orientación de rizaduras de playa a lo largo de la costa de Baja California. Recientemente los estudios de Flores y Galindo (1974) han encontrado indicios de este tipo de circulación en el alto Golfo de California en base a mediciones hidrográficas realizadas en dicha zona. Los estudios de García (1974) aportan más evidencias a esta posibilidad pues encontró una gran cantidad de partículas en suspensión en lo que fué la boca del Río Colorado, y que la turbidez producida por estas partículas se extiende más hacia el sur en la zona costera de Baja California que en la de Sonora. Asimismo Farfán (1974) encontró que las concentraciones de biomasa planctónica son mayores en las costas de Baja California que en las de Sonora. Todos estos argumentos contribuyen a la evidencia de que existe una corriente en este sentido. La mayor abundancia de materiales en suspensión y de plancton en la zona cercana a la segunda estación, puede ser causada de haber encontrado allí una mayor cantidad de residuos de DDT, pues este compuesto se incorpora a los organismos planctónicos y a la materia en suspensión los cuales son asimilados por las almejas al filtroalimentarse.

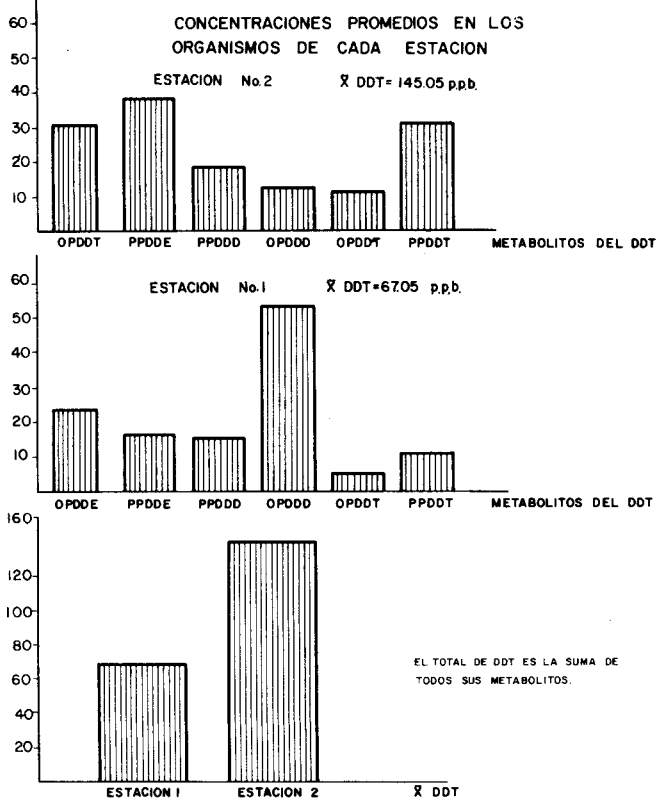
El segundo factor que pudo haber contribuido a que se hayan encontrado los valores más altos de residuos en la Estación 2 de la zona marina es el viento. Si existe una predominancia de los vientos en dirección de la segunda estación, los insecticidas organoclorados acarreados por el viento se depositarán en mayor cantidad en esa área; esta posibilidad es reforzada por los estudios de Alvarez (1971) mencionando anteriormente, quien encontró que los vientos dominantes en la mayor época del año tienen una dirección noroeste-sureste, o sea en dirección del Valle de Mexicali hacia el alto golfo.

Estos dos factores son los únicos considerados para dar una explicación al hecho de haber encontrado una mayor cantidad de residuos de DDT en la Estación 2 que en la Estación 1 de la zona marina, ya

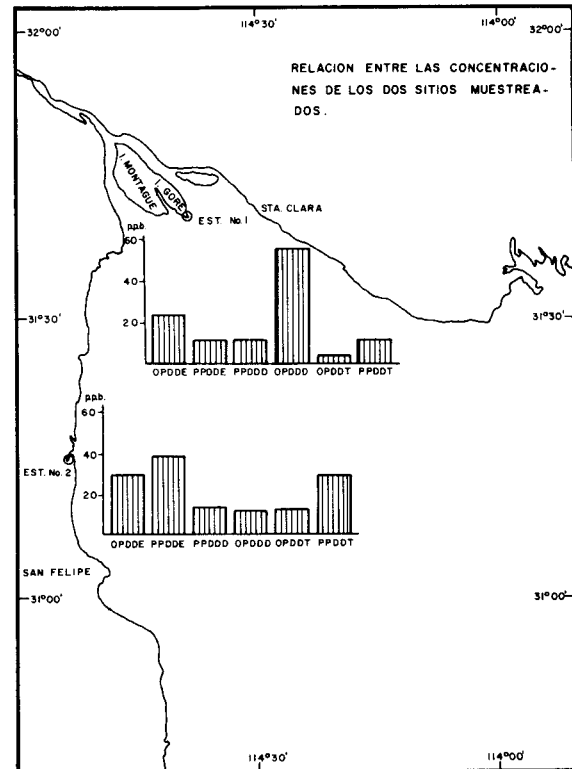
que el acarreo hidráulico de este contaminante puede considerarse despreciable pues las precipitaciones en la zona terrestre circundante al alto Golfo de California son casi nulas durante todo el año.

## CONCLUSIONES

En base a los resultados obtenidos es evidente el alto grado de contaminación por DDT que han alcanzado los organismos en las zonas de estudio. Los niveles de concentración de estos contaminantes han rebasado los límites tolerables (5 ppm en peso húmedo) por la mayoría de los seres vivos, incluyendo al hombre (Drug and Food Administration).

Las especies que forman parte constitutiva del ecosistema de la parte norte del Golfo de California están acumulando en sus organismos residuos de DDT, y dado que la mayoría de estas especies son utilizadas como alimento humano, los consumidores están expuestos a sufrir los efectos fisiológicos producidos por este contaminante.

Es evidente el acarreo eólico de una porción de los insecticidas aplicados en los campos de cultivo del Valle de Mexicali hacia la zona del alto Golfo de California, por lo que constituyen un peligro para el equilibrio ecológico de esta zona, y que podría contribuir a la disminución en abundancia del recurso pesquero más importante de la región, como lo es el camarón. No es muy remota la posibilidad de que este contaminante también haya contribuido en parte a llevar a las puertas de la extinción a la totoaba que anteriormente constituyó un recurso importante para las pesquerías de la región.

Para tratar de demostrar lo anterior, es evidente la importancia que adquiere la realización de estudios más profundos sobre el tema, como sería por ejemplo una investigación sobre efectos fisiológicos del DDT en especies marinas comercial y ecológicamente importantes.

## RECOMENDACIONES

Al usarse otros métodos de control de plagas y dejar de incorporarse los pesticidas al ambiente, los ya existentes en él se degradaría a largo plazo y los organismos también lo eliminarían gradualmente, con lo cual terminaría la amenaza que constituyen estos contaminantes sobre el equilibrio ecológico mundial.

Otros métodos de control de plagas podrían ser los siguientes:

- a). El uso de pesticidas de corta vida media, algunos tipos de pesticidas como los fosfatos orgánicos, son descompuestos en el ambiente en días o semanas, lo cual no permitiría a los organismos el suficiente tiempo para asimilarlos.
- b). El uso de enemigos naturales de los insectos, como predadores, bacterias o parásitos.
- c). Técnicas de esterilización sobre las plagas.

## RECONOCIMIENTOS

Es mi interés el hacer patente que esta investigación se hizo posible gracias a la valiosa asesoría que me brindó el Gilberto Flores Muñoz, Maestro-Investigador de la Unidad de Ciencias Marinas, al poner a mi disposición su material bibliográfico, conocimientos y experiencia que sobre pesticidas organoclorados y química general posee.

De la misma manera agradezco la ayuda y cooperación que en todo momento mostró el Carlos Eugenio Suárez Vidal, siendo de vital importancia para la terminación del trabajo sus conocimientos y experiencia que sobre el tema y la oceanografía en general domina.

El presente trabajo formó parte de una tesis conjunta por lo cual quiero hacer patente mi agradecimiento al Orlando Núñez Esquer por su valiosa ayuda mediante la cual ha sido posible la terminación del mencionado trabajo.

- Alvarez, L. G. 1971. Vientos en la Bahía de Todos Santos. Publicación del Instituto de Investigaciones Oceanológicas. U.A.B.C.
- Avalos, M. H. 1974. Análisis del desarrollo de las pesquerías del camarón y la totoaba. Unidad de Ciencias Marinas. U.A.B.C.
- Bitman, J., Cecil, H. C., and Fries, G. F. 1970. DDT-induced inhibition of avian shell gland carbonic anhydrase: a mechanism for thin eggshells. *Science*, 168(3931): 594-595.
- Conney, A. R. 1967. Pharmacological implications of microsomal enzyme induction. *Pharmacological Review*. 19.
- Farfan, B. C. 1974. Estimación de biomasa de zooplancton en la zona norte del Golfo de California. Tesis Profesional. Unidad de Ciencias Marinas. U.A.B.C.
- Flores, B. B., Galindo, L. B. 1974. Hidrografía del alto Golfo de California. Tesis Profesional. Unidad de Ciencias Marinas. U.A.B.C.
- García, G. L. 1974. Elementos sobre la distribución de turbidez en el alto Golfo de California. Tesis Profesional. Unidad de Ciencias Marinas. U.A.B.C.

- Jackson, Wes. 1971. *Man and the Environment*. Wn. C. Brown Company Publishers. Library of Congress Catalog card number 72-86732. pp. 81-89.
- Kodoum, A. M. Modification of the Micromethod of Sample Cleanup (1968) for Thin-Layer and Gas Chromatographic Separation and Determination of Common Organic Pesticide Residues. *Bull. Environ. Cont. & Tox.*, 3(6): New York, Inc.
- Koelle, G. B. 1963. Cholinesterase and anticholinesterase agents. *Handbuch der Exptl. Pharmacologic*, Suppl. 15, Springer Verlag.
- Man's Impact on the Global Environment. Report of the Study of Critical Environmental Problems (SCEP). (1970). The Massachusetts Institute of Technology. pp. 126-136.
- McGilvery, R. W. 1972. *Bioquímica*. Nueva Editorial Interamericana, S. A. de C. V. primera edición pp. 99-105.
- Nishikawa, K. K., y otros 1971. Estudio químico sobre la concentración de insecticidas organoclorados en organismos de la parte norte del Golfo de California y desembocadura del Río Colorado. Instituto de Investigaciones Oceanológicas, U.A.B.C.
- O'Brien, R. D. 1967. *Insecticidal action and metabolism*. Academic Press New York and London.
- Peakall, D. B. 1970. p,p-DDT: Effect on calcium metabolism and concentration of estradiol in the blood. *Science*, 168(3931): 592-594.
- Schwartz, H. L., Kozyreff, W., Surks, M. I., and Oppenhermer, J. H. 1969. Increased deiodination of L-Thyroxine and L-Triiodothyronine by liver microsomes from rats treated with phenobarbital. *Nature*, 221: 1262-1263.
- Skou, J. C. 1965. Enzymatic basis for active transport of Na<sup>+</sup> and K<sup>+</sup> across cell membrane, *Physiol. Rev.* 45.
- Thompson, R. W. 1969. Tidal currents and general circulation.: 51-55. In: *Environmental impact of brine effluents on Gulf of California*. U.S. Dept. Int., Res. and Dev. Prog. Rept., (387): 1-207.
- Woodwell, G. M., Wurster, C. F., and Isaacson, P. A. 1967. DDT residues in an east coast estuary: A case of biological concentration of a persistent insecticide. *Science* 156(3776): 821-824.

# ELEMENTOS SOBRE LA DISTRIBUCIÓN DE TURBIDEZ EN EL ALTO GOLFO DE CALIFORNIA

GUADALUPE GARCÍA DE BALLESTEROS

y

MICHEL LARROQUE

Unidad de Ciencias Marinas  
Universidad Autónoma de Baja California  
Ensenada, Baja California

## ABSTRACT

This paper attempts to establish the causes of the presence and permanence of turbidity in the upper Gulf of California. Seasonal data were collected in May and October 1973. By means of quantitative, qualitative, and grain-size analysis, distribution graphs were plotted. It was concluded that the observed turbidity results from the resuspension of recently deposited Colorado River sediments. It is thought that this resuspension is caused by net tidal flux and reflux as well as wind generated wave action.

## RESUMEN

En este trabajo se tratan de establecer las causas de la presencia y permanencia de la turbidez en el alto Golfo de California. Para esto, se llevaron a cabo dos muestreos uno en mayo y otro en octubre de 1973. Por medio de análisis cualitativo, cuantitativo y granulométrico de las muestras se elaboraron gráficas de distribución y a partir de ellas se concluye que los factores que determinan la presencia del material son principalmente los sedimentos superficiales de fondo aportados antiguamente por el Río Colorado. También se establece que los principales factores dinámicos de la turbidez son, la corriente neta, el flujo y reflujo de las mareas y el efecto del oleaje sobre el fondo.

## AGRADECIMIENTOS

El presente trabajo fué elaborado en el Instituto de Investigaciones Oceanológicas de la Unidad de Ciencias Marinas, bajo contrato con la Secretaría de Recursos Hidráulicos. Los autores agradecen a Daniel Muñoz Ferreira, Director del Departamento de Acuicultura de dicha Dependencia, el haber permitido su publicación. Se agradece además a Saúl Alvarez Borrego, Coordinador General de la Unidad de Ciencias Marinas, por sus consejos durante la elaboración de este estudio; a Richard Schwartzlose de la Institución Scripps de la Joya, por haber subsidiado el crucero de septiembren-octubre y a la Universidad de Sonora por permitirnos utilizar su embarcación Adventyr durante los cruceros. Y nuestra gratitud a los compañeros: Bernardo Flores, Luis Galindo, Roberto Pérez Higuera, José Luis Ortega, Marcos Miranda, Claudia Farfán, y Salvador Galindo por la participación que tuvieron en la toma de muestras en el campo.

## INTRODUCCIÓN

La presencia de material en suspensión en el medio marino es un factor que puede transformarse en una característica limitante en un ecosistema dado. Esto es cierto principalmente en lugares como el alto Golfo de California y desembocadura del Río Colorado, en donde las aguas con un alto contenido de material en suspensión establecen condiciones de tipo ambiental muy diferentes a las de una zona de aguas oceánicas, limitando la distribución de gran número de especies, tanto planctónicas como invertebrados y peces marinos.

La zona donde se llevó a cabo el estudio es el alto Golfo de California, de latitud aproximadamente 31° N hacia el norte, hasta la desembocadura del Río Colorado.

Los conocimientos que se tienen sobre este material en suspensión en el área antes mencionada son realmente pocos. Thompson (1965) determinó la batimetría y distribución superficial de los sedimentos de fondo en esta área (Figura 22 y 23). Gayman (1969) elaboró un trabajo sobre turbidez en la misma área, sólo que tomó en cuenta aportes de limos y arcillas del Río Colorado; en la actualidad dichos aportes son nulos, por lo que hay que establecer las razones de dicha turbidez. Zeitzchel (1970) llevó a cabo un análisis cuantitativo del material en suspensión en el Golfo de California, sólo que en este trabajo no se muestreó sino hasta la altura de latitud 30° N aproximadamente.

Los objetivos de este trabajo son, establecer la distribución del material en suspensión en el área de estudio; conocer las características de este material a través de análisis cualitativo, cuantitativo y granulométrico; determinar la dinámica y los factores que afectan el transporte y la permanencia de este material. Se estima que los resultados de este estudio sirvan para futuras investigaciones de tipo biológico que se lleven a cabo en esa área.

*Características Generales del Área de Estudio.* Es un área triangular, formada por el Golfo de California, el Puerto de San Felipe en el suroeste, Puerto Peñasco en el sureste y en el extremo norte el Delta del Río Colorado (Figura 1). La región del Delta del Río Colorado representa un complejo estructural, la depositación se inició sin interrupción quizás desde el Mioceno y en menor proporción en el Cenozoico (Alvarez, 1973), y ha actuado hasta antes de los últimos diez años. La construcción de

varias presas durante la segunda mitad del siglo XX, particularmente la Presa Imperial (California, E.U.A.) y la Presa Morelos (Algodones, B.C.), han provocado un cambio radical en el sistema hidrológico del Río Colorado.



FIGURA 1. Localización geográfica del área de estudio.

En el período 1950–1960, el promedio anual de sedimentos que llegó al lindero norte inmediatamente aguas arriba de la Presa Morelos, fué de 870,000 m<sup>3</sup>, y durante el período 1960–1970 llegaron a la Presa Morelos un promedio de 150,000 m<sup>3</sup> anuales (Alvarez, 1973). Por otra parte se ha tenido que abandonar la estación hidrométrica “El Mareógrafo”, situada 138 km aguas abajo de la Presa Morelos y 22 km río arriba de la desembocadura, por azolvamiento completo del cauce. Así también los datos de salinidad del área, muestran valores más elevados en la parte norte que en la parte sur del delta. Este conjunto de datos prueba que en la actualidad no existe ningún aporte de agua dulce y de material por parte del Río Colorado, los únicos aportes de agua dulce a esta área son producidos por las escasas lluvias que provocan una circulación temporal en los ríos Hardy, Santa Clara y otros más pequeños. De esto podemos concluir que aunque la

región del Delta del Colorado no ha llegado todavía a un perfil de equilibrio, se puede considerar que es un candidato a la fosilización.

En el lado oeste del área se encuentra el Estado de Baja California, el cual la protege por medio de la Sierra de San Pedro Mártir y cordilleras más pequeñas. Estas cordilleras están constituidas en su mayoría por rocas ígneas y metamórficas del Pre-Cretácico y Cretácico. El área de la planicie costera, situada entre San Felipe y la boca del Río Colorado, está constituida por barras de lodo y depósitos de sal, cuyos sedimentos provinieron del Río Colorado. Los sedimentos son limos, arcillas y evaporitas de edad reciente.

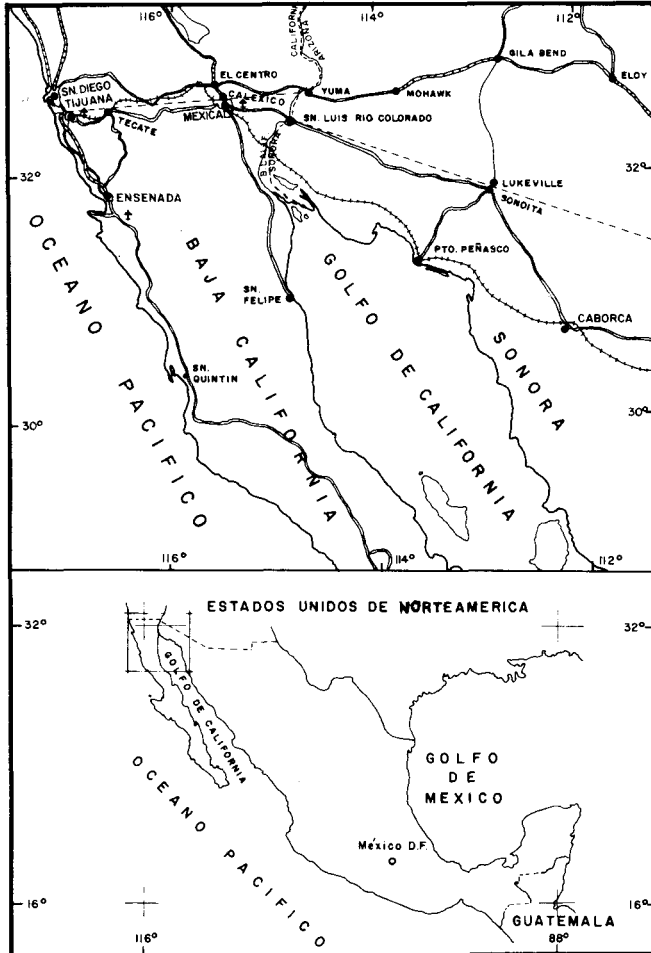
En la parte noreste se encuentra el desierto de Sonora o de Altar. Cerca de la costa el desierto está constituido por una planicie aluvial de arenas y gravas estratificadas, las cuales están parcialmente cubiertas por dunas de arena. El área desierta consiste principalmente de sedimentos recientes y del Pleistoceno, sedimentos clásticos de fines del Pleistoceno, sedimentos de fines del Cenozoico y sedimentos volcánicos y granito del Mesozoico y Precámbrico (Schreiber, 1969). Punta Pelicano, a unas cuantas millas al oeste de Puerto Peñasco, consiste de un granito del Mesozoico entrelazado con pegmatita y diques de aplita. Punta Peñasco, la Colina Oscura de Puerto Peñasco y la Montaña Negra, localizadas al oeste de Punta Pelicano, son de basalto. La región del Penacate es una zona de basalto volcánico, la cual ocupa un área de 1600 km<sup>2</sup> de desierto; 55 km al norte de Puerto Peñasco y 65 km al oeste de Lukeville, Arizona (Schreiber 1969).

*Características Meteorológicas.* El tipo de clima del área es de desierto continental, con humedad y pluviosidad escasas. La media de lluvias para los meses de enero a octubre de 1973 es de 0.11 mm, (Sec. Rec. Hid. Del. Ensenada). El área está situada en una región árida, en donde la evaporación excede al afecto conjunto de la precipitación y aporte de los ríos (Green, 1969).

El clima árido se debe a dos factores; carácter general de la circulación atmosférica alrededor del centro de baja presión sobre México, y la Sierra alta y continua de la península de Baja California, la cual previene que el Océano Pacífico ejerza su influencia sobre la región, por lo que se puede decir que el área está controlada por un clima de tipo continental (Roden, 1957).

La distribución de temperatura del aire muestra valores mínimos en enero y febrero y máximos en julio y agosto. La media para los meses de enero a octubre de 1973 es de 22.2° C (Sec. Rec. Hid. Del. Ensenada). En general, el aire es más templado que el mar durante la primera mitad del año y más frío durante la segunda.

La distribución de los vientos muestra velocidades promedio bajas 9m/s para mayo; 11m/s para junio; 5m/s para julio; 3.7m/s para agosto y 5.8m/s para septiembre–octubre de 1973 (Datos de Cruceros).



La dirección de los vientos varía con la estación del año. Durante invierno los vientos del norte son predominantes; en primavera (mayo), los vientos dominantes fueron del sur, y durante los meses de otoño las direcciones fueron muy irregulares sureste, noreste y noroeste (Datos de Cruceros hidrográficos del I.I.O., 1972-73).

**Características Oceanográficas.** Las variaciones más grandes de temperatura en el Golfo de California ocurren en la parte cercana al delta, y generalmente en esta parte las aguas superficiales son más templadas en la región central del golfo. La salinidad superficial es más alta que la de las aguas de la misma latitud que se encuentran en el océano Pacífico del otro lado de la península de Baja California, esto se debe a la gran evaporación y a la ausencia de corrientes oceánicas en esta parte del golfo. La salinidad en la superficie varía mucho a lo largo del año, pero en general se observan gradientes ascendentes durante el verano en dirección noroeste.

Las mareas aumentan en amplitud de la boca del golfo a la costa del delta. Roden (1964) muestra un rango medio anual de más o menos 1 m en la boca del golfo y 7.3 m en la cabeza. El período de oscilación de mas mareas en esta área es semidiurno (Mathews, 1969).

La circulación superficial en el área está probablemente dominada por las corrientes de marea, sin embargo, todavía se sabe poco de la magnitud y dirección de estas corrientes así como de la circulación general. Thompson (1965) indica que la corriente de marea es casi rectilínea y que fluye paralela a los ejes del golfo. Las máximas velocidades se generan cerca del nivel medio de marea, durante el flujo.

Para resolver la interrogante planteada por Thompson (1969) sobre el sentido del giro de la corriente neta, sin tomar en cuenta el flujo y reflujos de las mareas en esta parte del golfo, se hicieron observaciones de los análisis hidrológicos llevados a cabo en esta área. Se nota que los parámetros fisicoquímicos del extremo norte afectan a las aguas adyacentes a Baja California, y los parámetros de la parte central del golfo afectan a las aguas aladeñas a Sonora. Por lo que se determinó que el sentido del giro es contrario al de las manecillas del reloj.

## MATERIALES Y MÉTODOS

### Lista de Materiales

#### Muestreo

- 1 botella Van Dorn de 3 lts.
- 60 recipientes de plástico de 4 lts.
- 1 disco de Secchi

#### Análisis de laboratorio

- Aparato de filtración Millipore
- Filtros Nuclepore con poros de 8, 5 y 3 micras
- Bomba de vacío de 0.3 atm de presión

- Turbidímetro óptico Hellige No. 8000
- Agitador magnético
- Balanza analítica con aprox. de .0001 g
- Estufa
- Pinzas
- Magnetos
- Vidriería de laboratorio

#### Reactivos

- Agua destilada
- Peptizador ( $\text{Na}_2\text{CO}_3$  0.1N)
- Agua oxigenada al 30%.

#### Métodos

**Muestreo.**—El plan de estaciones establecido (Figura 2), tiene en total 25 estaciones, notándose una mayor densidad en el extremo norte, debido a que esta es la zona en donde se encuentra la mayor cantidad de material en suspensión.

En total se llevaron a cabo dos cruceros, el primero en el período del 21 al 24 de mayo y el segundo del 30 de septiembre al 2 de octubre 1973 por lo que podemos considerarlas como condiciones de primavera y otoño. En el crucero de mayo se tomaron muestras en todas las estaciones y a tres niveles: superficie, cinco metros y diez metros (cuando la batimetría lo permitió), mientras que en el crucero de octubre sólo se muestreó en las estaciones de la 1 a la 18, a un solo nivel: superficie.



FIGURA 2. Plan de estaciones.

Las muestras fueron tomadas con botellas Van Dorn y depositadas después en recipientes de plástico numerados. El volumen de la muestra varió entre 1 y 4 litros.

Se hicieron también en cada estación observaciones de la transparencia de las aguas con el disco de Secchi. La precisión de este disco no está bien establecida, ya que depende de un gran número de factores, tales como ángulo de incidencia de la luz, lado del barco donde se lleva a cabo la medición, nubosidad, tipo de fondo, efectos del viento sobre la superficie del agua, corrientes, etc.; sin embargo, es común tomar como rango de precisión  $\pm 1$  m.

*Análisis de Laboratorio.* Se llevaron a cabo análisis de tipo cualitativo, cuantitativo y granulométrico. Además se hicieron determinaciones con el Turbidímetro Óptico y de cantidad de Materia Orgánica en el material en suspensión.

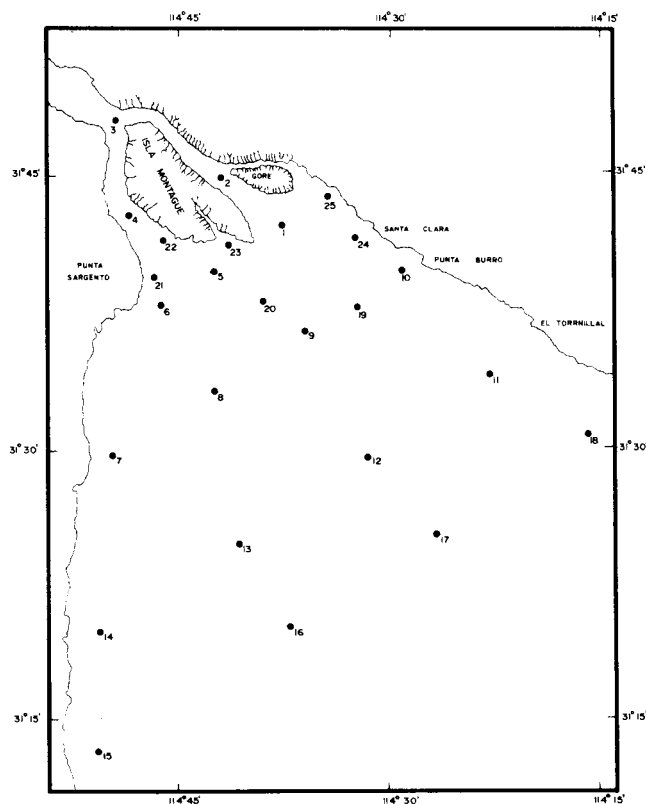
El análisis cualitativo se llevó a cabo en el campo con las mediciones hechas con el disco de Secchi, ya que se puede decir que dicho aparato da una idea cualitativa bastante buena de la turbidez.

Para los análisis cuantitativo y granulométrico de las muestras, se utilizó el método Millipore, el cual consiste en filtrar 100 ml de cada muestra en filtros del tipo Nuclepore cuyos poros tienen dimensiones de 8, 5 y 3 micras. Este método es experimental, por lo que su precisión no está aún bien establecida; las primeras 10 muestras fueron analizadas 6 veces cada una, y con ésto se determinó que la aproximación del método es de  $\pm 1$  mg/l.

Los pasos que se siguen a lo largo de todo el proceso son los siguientes:

1. Se colocan los filtros en cápsulas de petri de vidrio pyrex, con pinzas teniendo cuidado de no tocarlos con los dedos.

2. Se dejan durante cinco minutos aproximadamente, para que tomen la humedad del aire.

3. Se pesan en una balanza analítica con una aproximación de .0001 g.

4. Se colocan los filtros sobre el aparato de filtración Millipore, con pinzas, y se procede al filtrado de 100 ml de la muestra en cada uno de los filtros. Esto se lleva a cabo con una bomba al vacío de una presión de 0.3 atm. Cuando la muestra presenta gran cantidad de material, se filtra solamente un volumen de 50 ml. En algunas ocasiones se presenta floculación en las muestras, a éstas se les agregan 10 ml de peptizador ( $\text{Na}_2\text{NO}_3$  0.1N).

5. Se vuelven a colocar los filtros sobre las cápsulas de petri y se llevan a la estufa, en donde permanecen durante cinco minutos a  $60^\circ\text{C}$ , perfectamente secos.

6. Se sacan de la estufa y se dejan otros cinco minutos para que vuelvan a adquirir la humedad y temperatura del aire.

7. Se vuelven a pesar y la diferencia en peso es la cantidad de material adquirido en la filtración.

De los filtros de 3 micras se obtienen datos de cantidad de material en suspensión (seston), en mg/l, para cada estación; del conjunto de los tres filtros y sacando diferencia entre cada uno se determina la granulometría en cada muestra, pero solamente de estas tres dimensiones, debido a que este método no ofrece una escala grande de tamaños.

Las muestras obtenidas en el crucero de mayo fueron analizadas también con un Turbidímetro Óptico. Este aparato mide la turbidez en partes por millón, basándose en el principio de la penetración de un rayo luminoso a través de una cantidad de agua determinada. El Turbidímetro sólo mide la turbidez debida a partículas de  $\text{SiO}_2$  (Hellige Turbidimeter Directions), pero no determina material orgánico o de otra naturaleza.

En las muestras del crucero de octubre se hicieron determinaciones de la cantidad de materia orgánica. Para esto, lo que se hace es filtrar 100 ml de la muestra en un filtro de 3 micras en la misma forma antes mencionada y después de sacar la diferencia en peso, se vuelve a colocar el filtro en el aparato y, sin aplicar vacío se le agregan 15 ml de agua oxigenada al 30%, se deja así durante dos horas para que la materia orgánica sea oxidada y una vez pasado ese tiempo se aplica vacío y se lava el aparato con agua destilada, se saca el filtro, se seca y se vuelve a pesar. La diferencia en peso entre los dos filtrados determina la cantidad de materia orgánica en cada muestra, la cual se expresa en porciento. Este método también es experimental y su precisión no se conoce, tampoco se determinó si después de analizada la muestra quedó o no materia orgánica en la misma, sin embargo se puede decir que este método nos da una idea proporcional de la cantidad de materia orgánica que existe en el material en suspensión.

## RESULTADOS

Se llevaron a cabo, como se dijo anteriormente, dos cruceros, el primero en el período del 21 al 24 de mayo y el segundo del 30 de septiembre al 2 de octubre 1973, a bordo de la embarcación ADVENTYR de la Universidad de Sonora.

La localización de las estaciones en el campo (Figura 2) fué por estima, en algunas ocasiones no se ocuparon las estaciones del norte en el lugar exacto debido a que la profundidad es baja y las mareas son de gran amplitud.

Los resultados obtenidos fueron los siguientes:

1. *Transparencia de las aguas.* En la distribución de la transparencia del mes de mayo (Figura 3) se distinguen claramente tres zonas, la primera situada al noroeste del área de estudio en donde la transparencia es menor a 0.5 m; la segunda en una posición intermedia entre el noroeste y el sureste, observándose claramente paralela a la primera zona, en donde la transparencia varía entre 0.5 y 1.0 m y, por último, una tercera zona en donde la



FIGURA 3. Distribución de la transparencia de las aguas (profundidad en metros), determinados con el disco de Secchi. Mayo.



FIGURA 4. Distribución de la transparencia de las aguas (profundidad en metros), determinados con el disco de Secchi. Octubre.

transparencia es mayor a 1.0 m. En la primera zona existe un gradiente descendente hacia la costa de Baja California, mientras que en la segunda no existe ningún gradiente, notándose la posibilidad de dividir el área en dos zonas únicamente. En la tercera zona hay que notar que la transparencia aumenta muy rápidamente hacia el sureste, haciéndose esto más marcado hacia el centro del golfo que hacia los extremos, ya que en la Estación 17 hay 11 m de transparencia, mientras que en la 16 hay 5 y en la 18 hay 6 m.

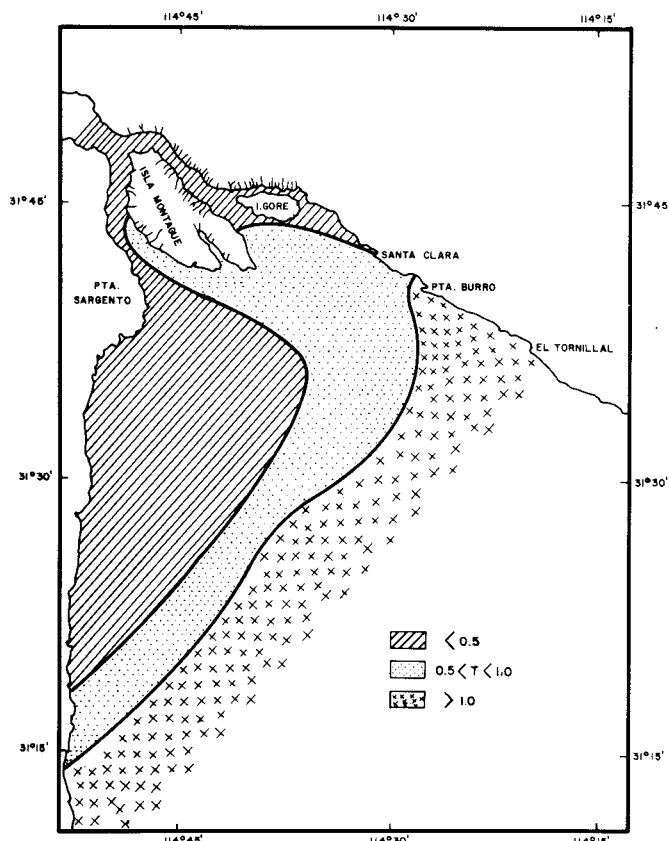
En la distribución de transparencia de octubre (Figura 4) se notan también tres zonas aunque éstas son menos claras, pero en los dos cruceros se observó como característica constante una mayor concentración de material, por lo tanto menor transparencia en la zona noroeste y un gradiente descendente en dirección suresta. La primera zona al noroeste tiene una transparencia menor a 1.0 m; en la segunda zona que está intermedia la transparencia varía entre 1.0 y 2.0 m y en la tercera es mayor a 2 m.

2. *Distribución de seston.* En el mes de mayo en superficie se observa una división del área en cuatro zonas muy bien marcadas (Figura 5). Una primera zona noroeste con valores de seston mayores a 100 mg/l, encontrándose un valor máximo de 132 mg/l en la Estación 7; en la segunda zona se nota un gradiente ascendente hacia el norte, ya que en la Estación 3 situada al norte de isla Montague, se encuentra un valor de 78 mg/l; en la tercera zona la cantidad de material disminuye hacia el sureste, y en la cuarta zona esta disminución se hace más marcada hacia el centro del golfo y en dirección sureste, encontrándose un valor mínimo para toda el área de 3 mg/l en la Estación 17.

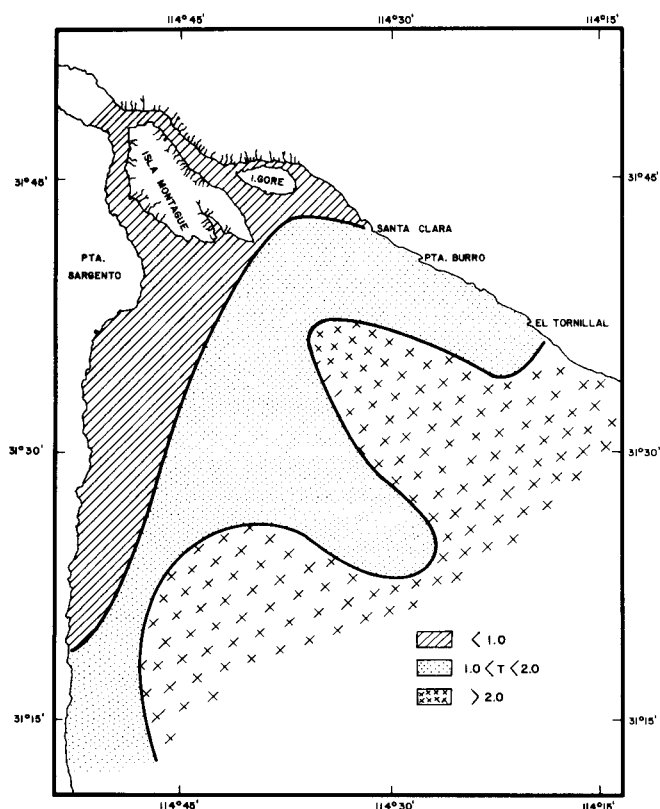
Las muestras tomadas a 5 m de profundidad no fueron suficientes para determinar curvas de distribución, sin embargo los resultados obtenidos se presentan (Figura 6), encontrándose valores máximos de 25 mg/l en las Estaciones 5 y 14 y un mínimo de 5 mg/l en la Estación 17.

A 10 m de profundidad el número de muestras fué aún menor (Figura 7), observándose un máximo de 14 mg/l en la Estación 13 y un mínimo de 4 mg/l en la Estación 11.

En la distribución superficial de seston de octubre (Figura 8), se encuentra el área dividida en tres zonas, con valores máximos de 16 mg/l en las Estaciones 5 y 6, y un mínimo de 1 mg/l en la Estación 13.

3. *Distribución del material en partes por millón (ppm), determinada con el Turbidímetro.* Sólo las muestras de mayo fueron analizadas con el Turbidímetro, y se obtuvieron tres gráficas, una para cada uno de los niveles muestreados. La gráfica de superficie es la única que presenta curvas de distribución, debido a que en las otras dos no se contó con el número de muestras necesario para establecerlas.



FIGURA 5. Distribución superficial de seston (mg/l). Mayo.



FIGURA 6. Seston (mg/l), a 5 m de profundidad. Mayo.

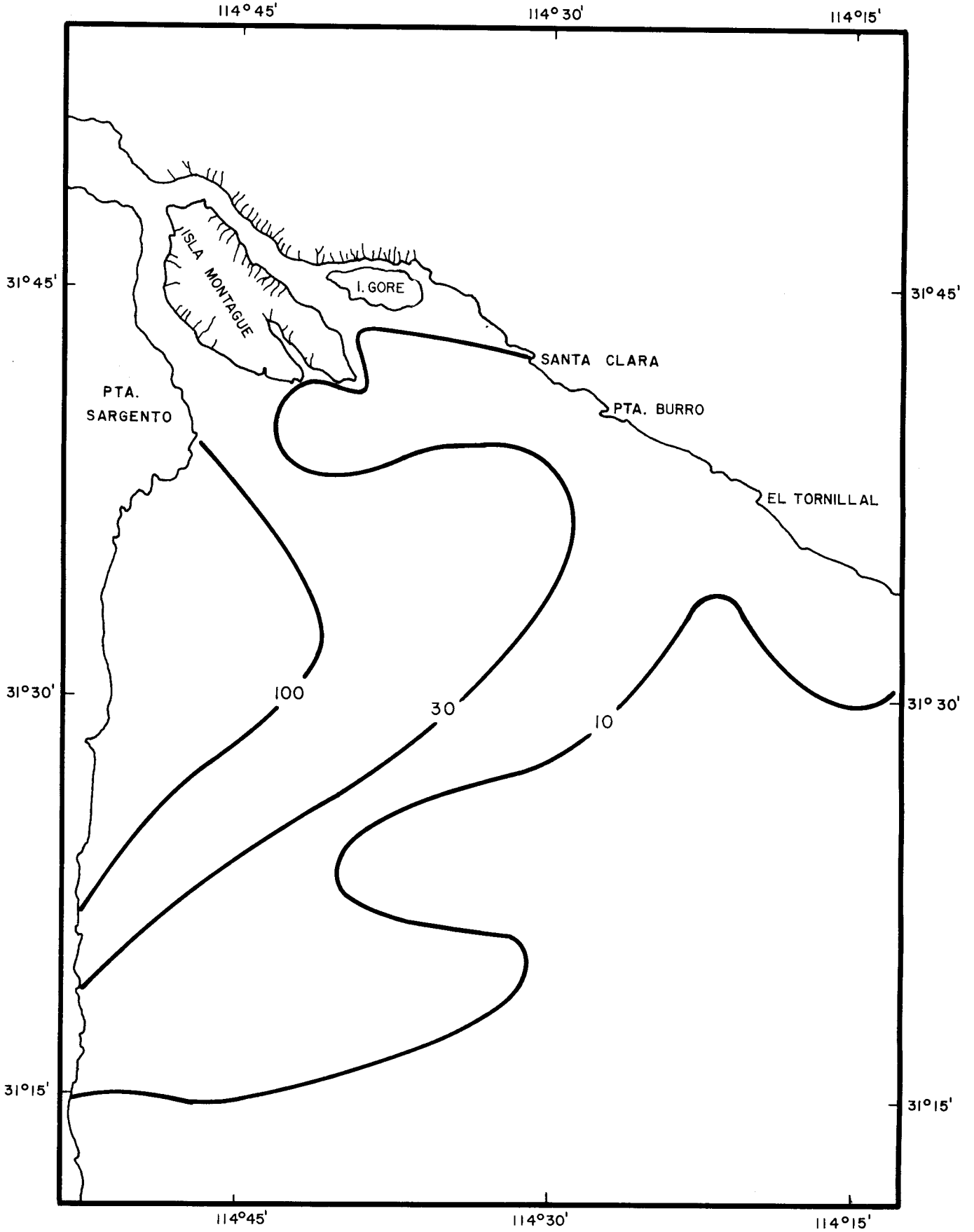

FIGURA 7. Seston (mg/l), a 10 m de profundidad. Mayo.

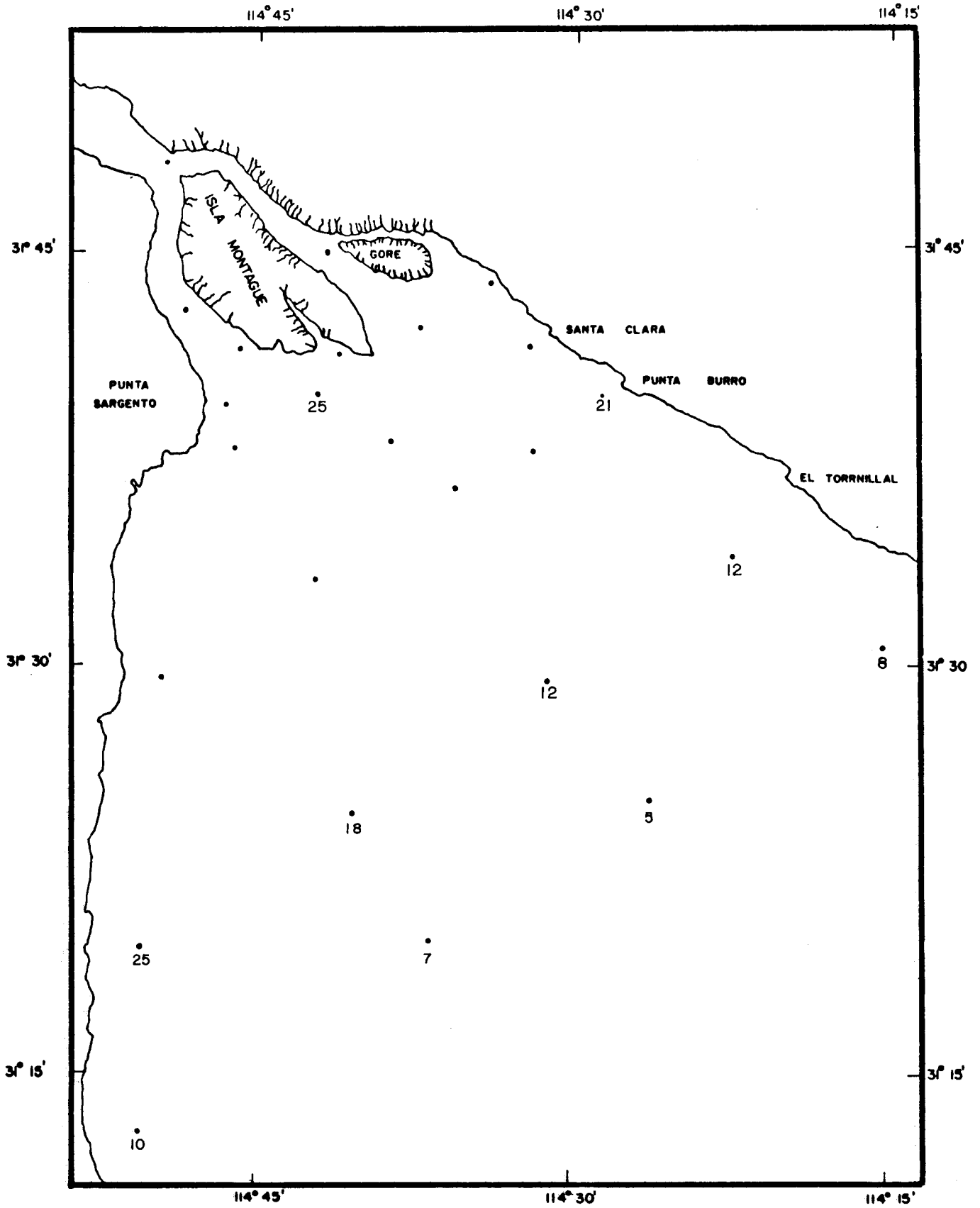

FIGURA 8. Distribución superficial de seston (mg/l). Octubre.

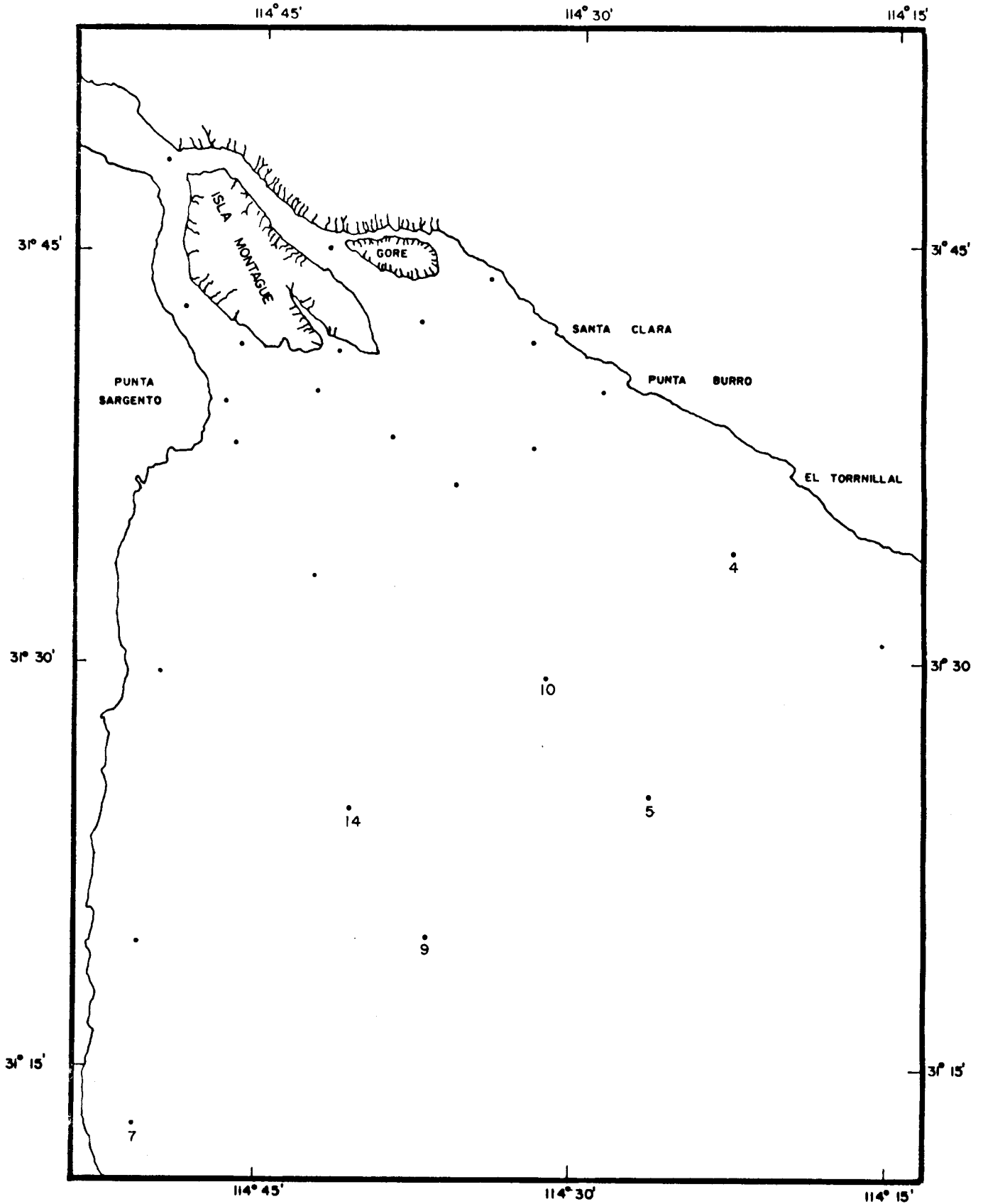

FIGURA 9. Distribución superficial del material en suspensión (p.p.m.), determinada con el turbidímetro. Mayo.



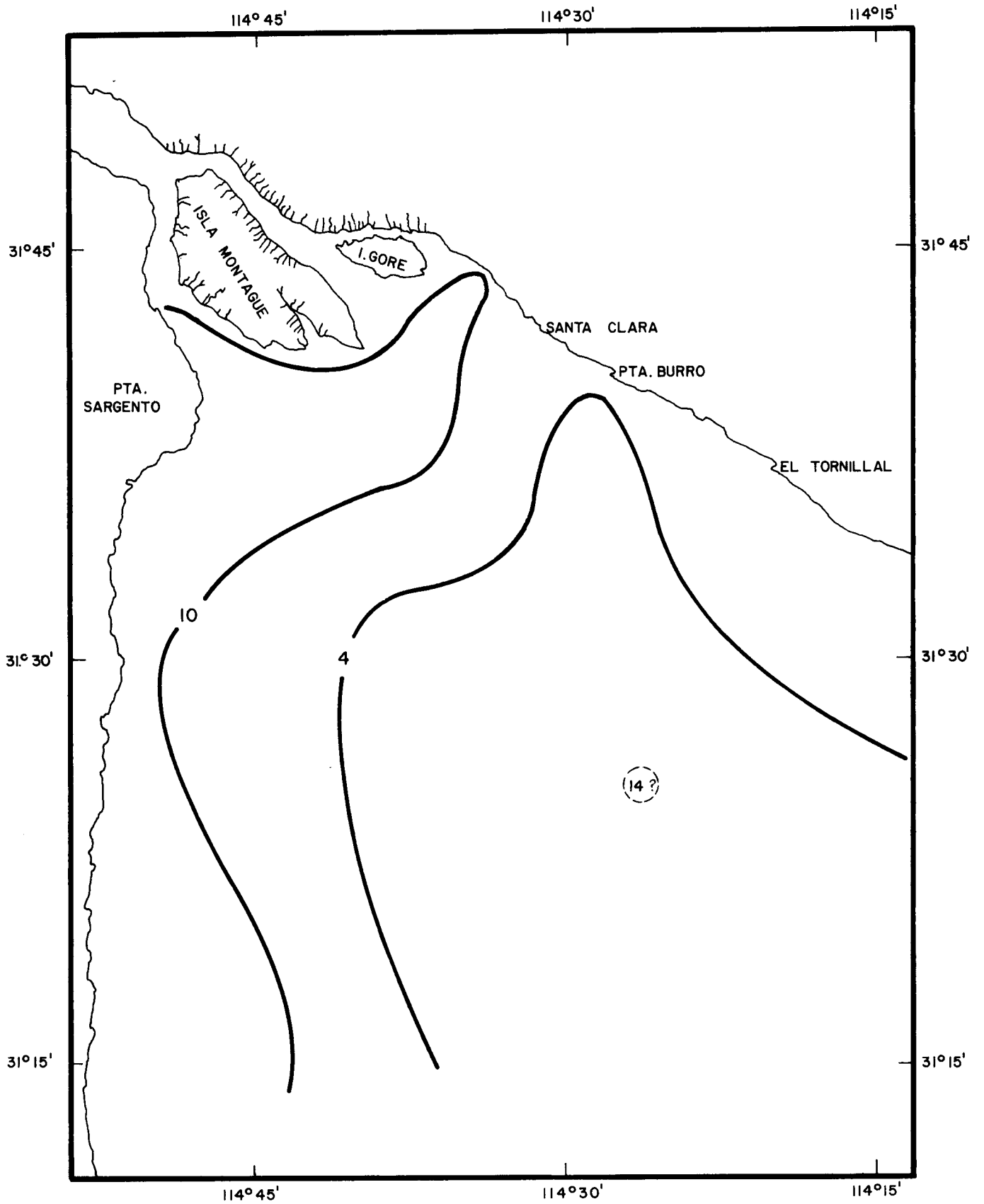

FIGURA 10. Material en suspensión (p.p.m.) a 5 m de profundidad. Mayo.

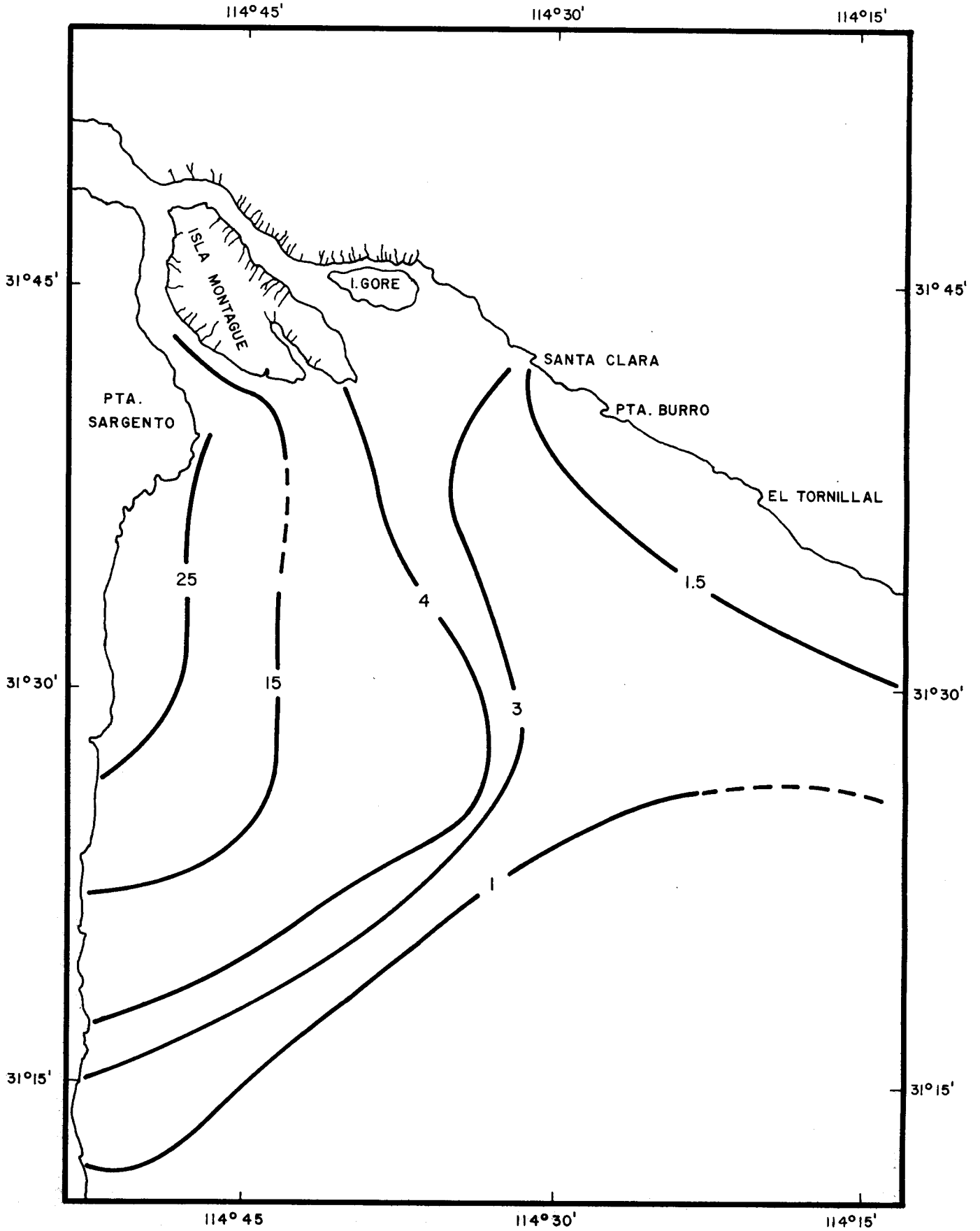

FIGURA 11. Material en suspensión (p.p.m.) a 10 m de profundidad. Mayo.

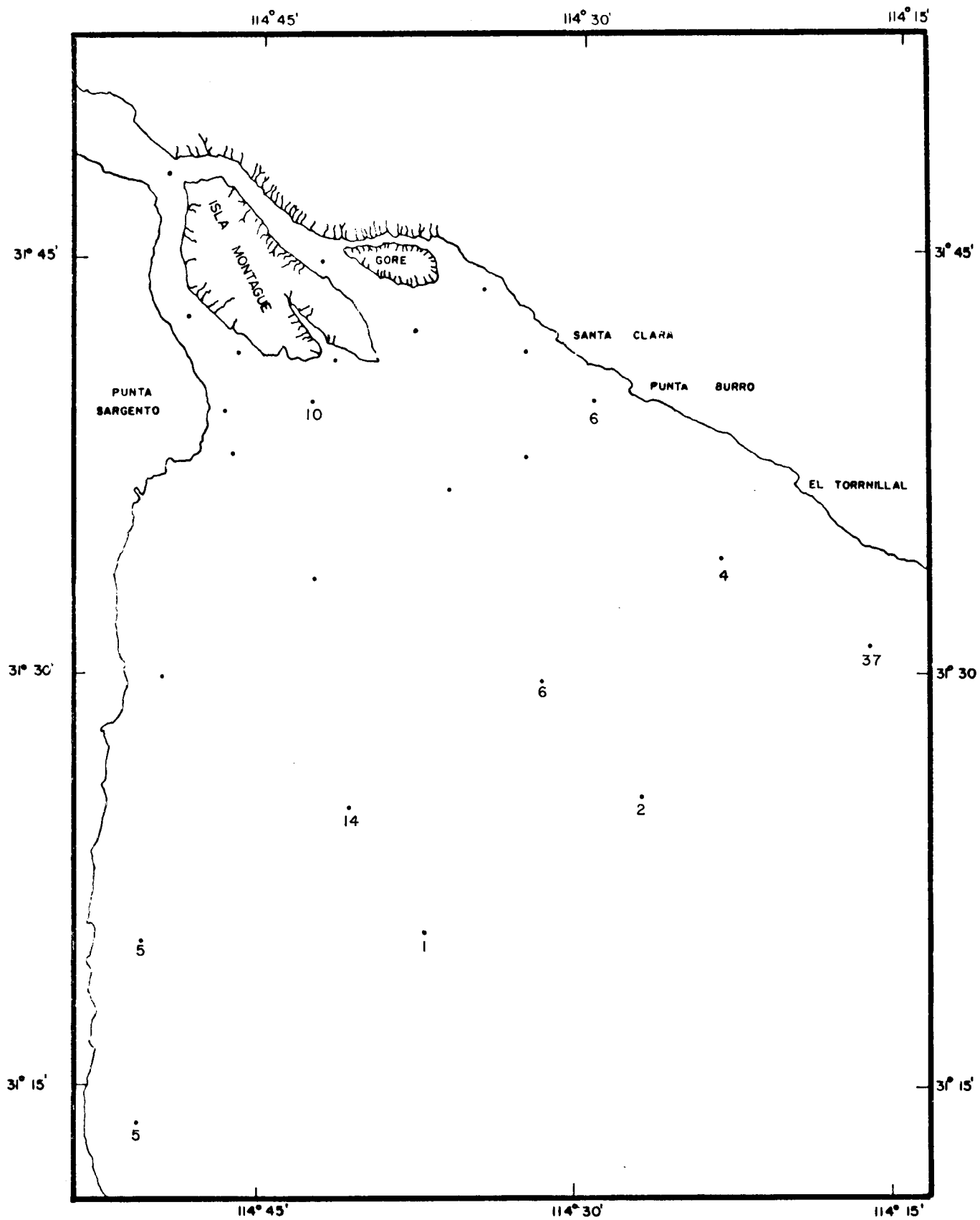

FIGURA 12. Distribución superficial de granulometria. Mayo.

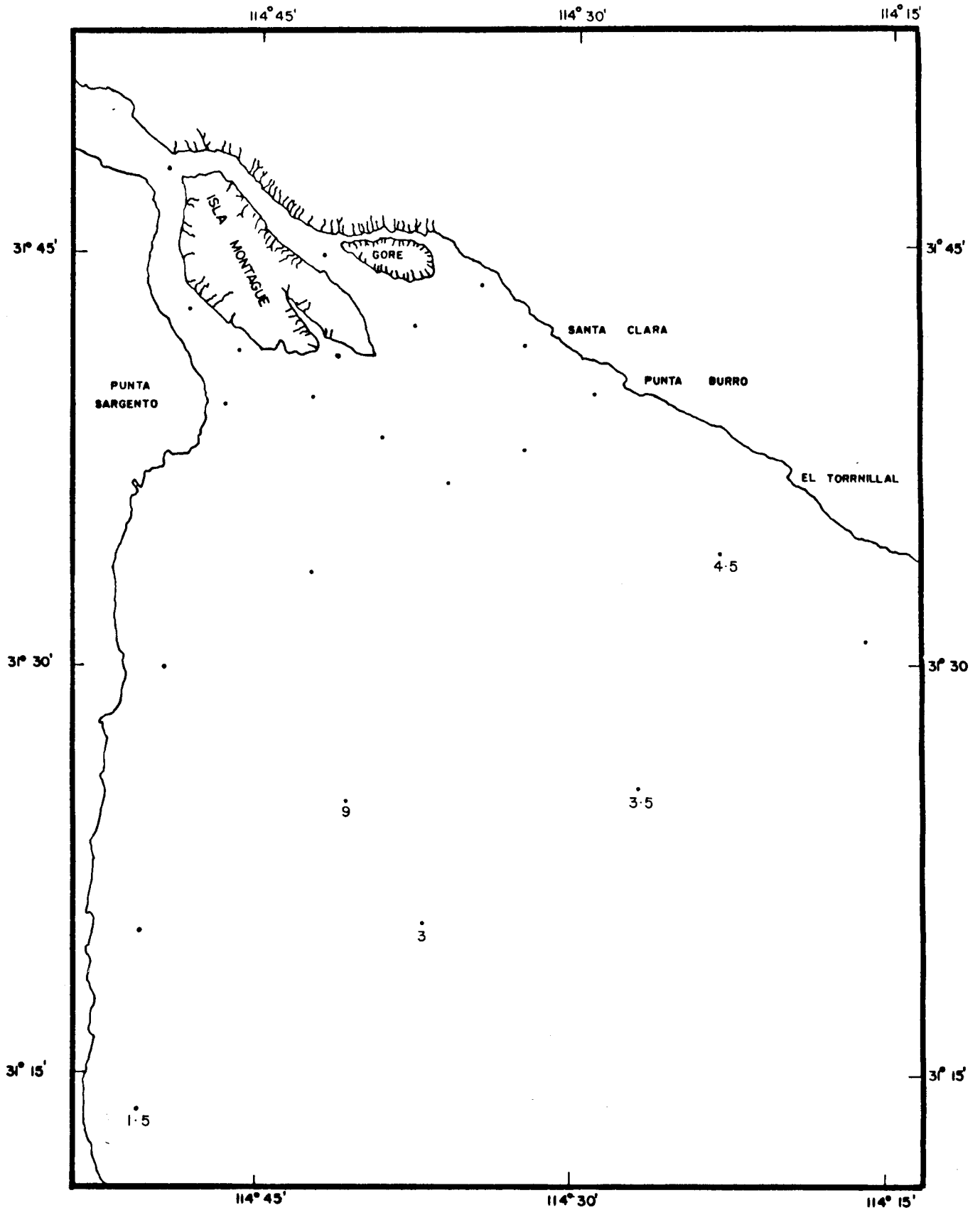

FIGURA 13. Distribución superficial de granulometria. Octubre.

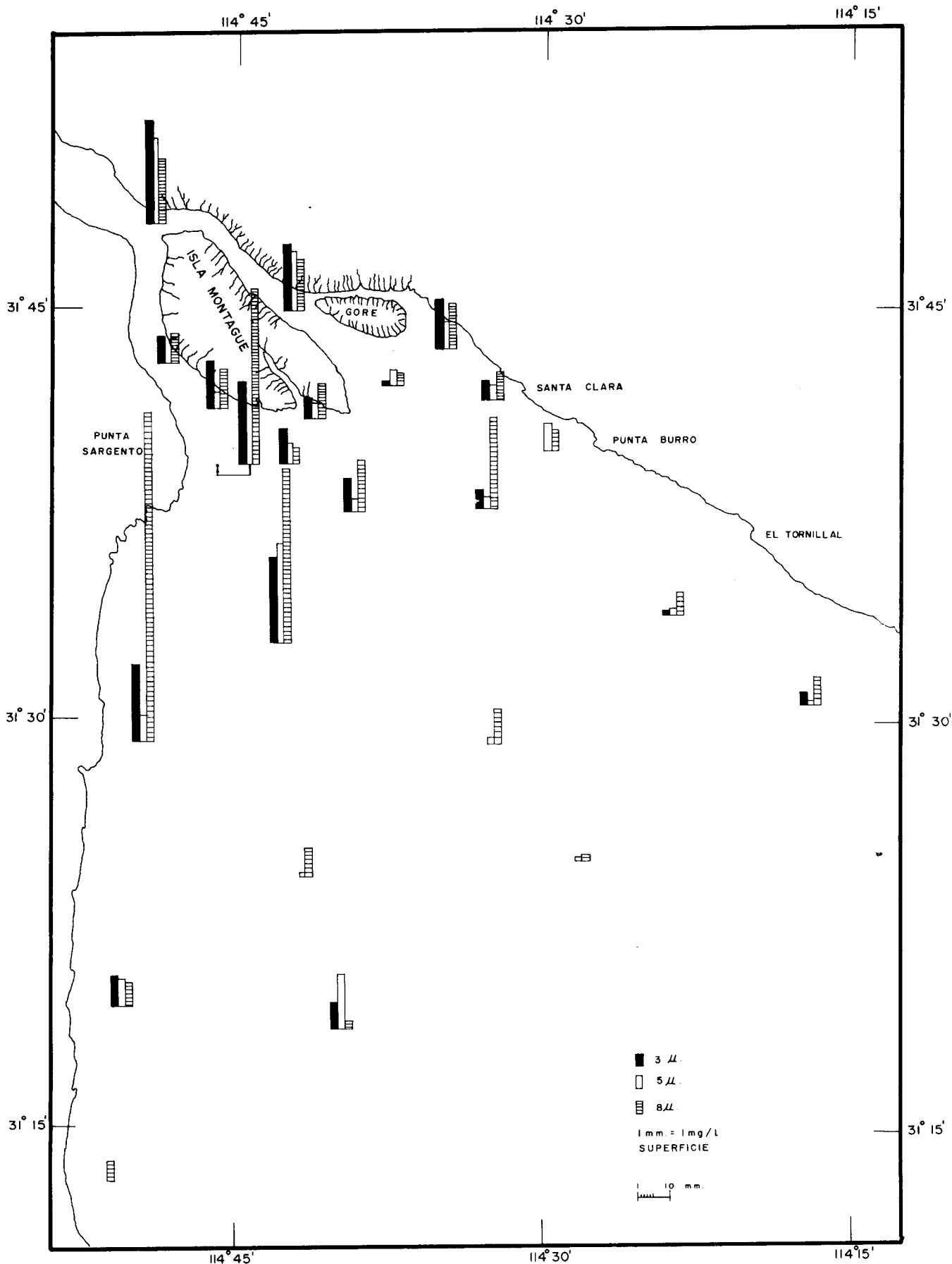

FIGURA 14. Distribución superficial de porcentaje de material mayor a 8 micras. Mayo.

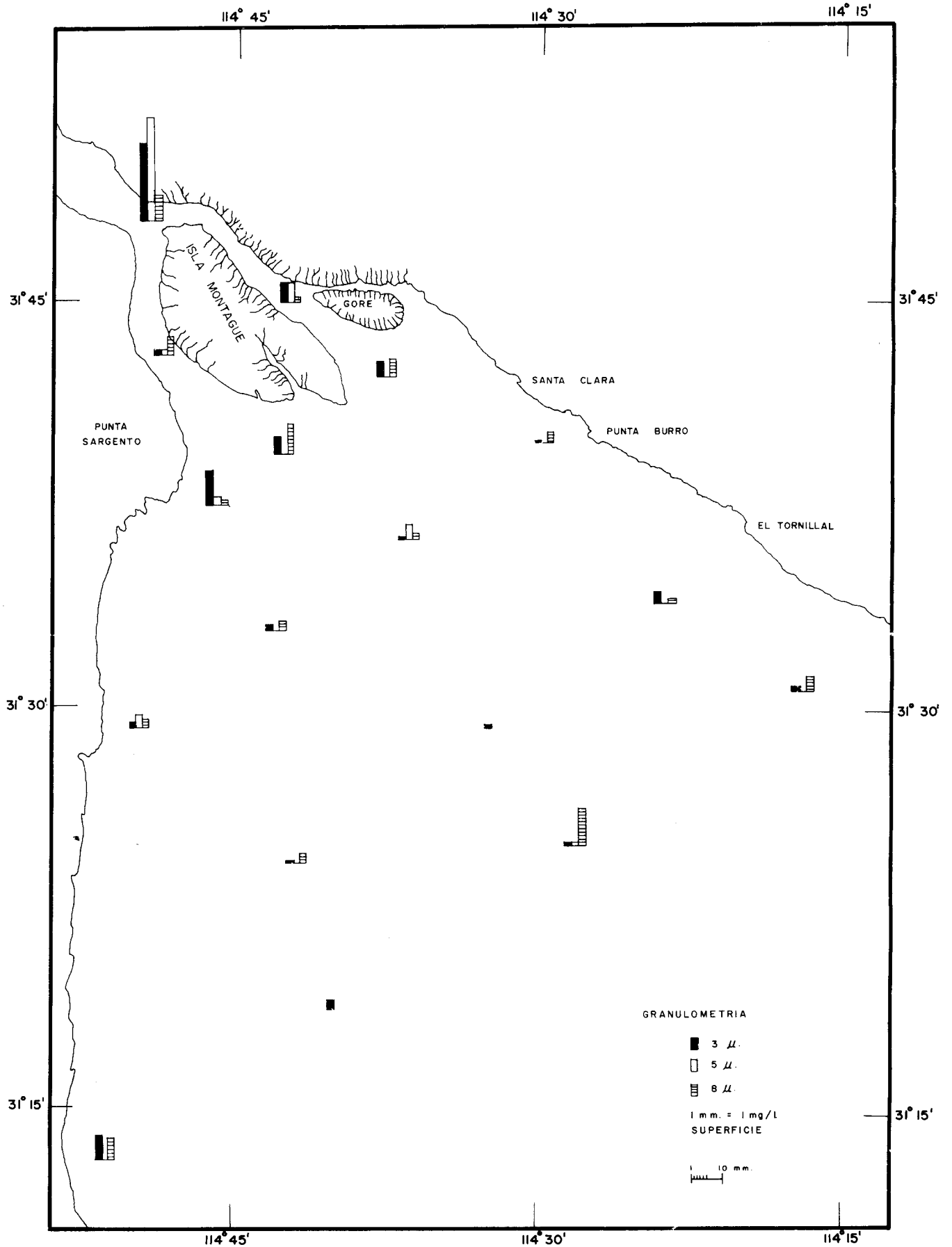

FIGURA 15. Distribución superficial de porcentaje de material entre 8 y 5 micras. Mayo.

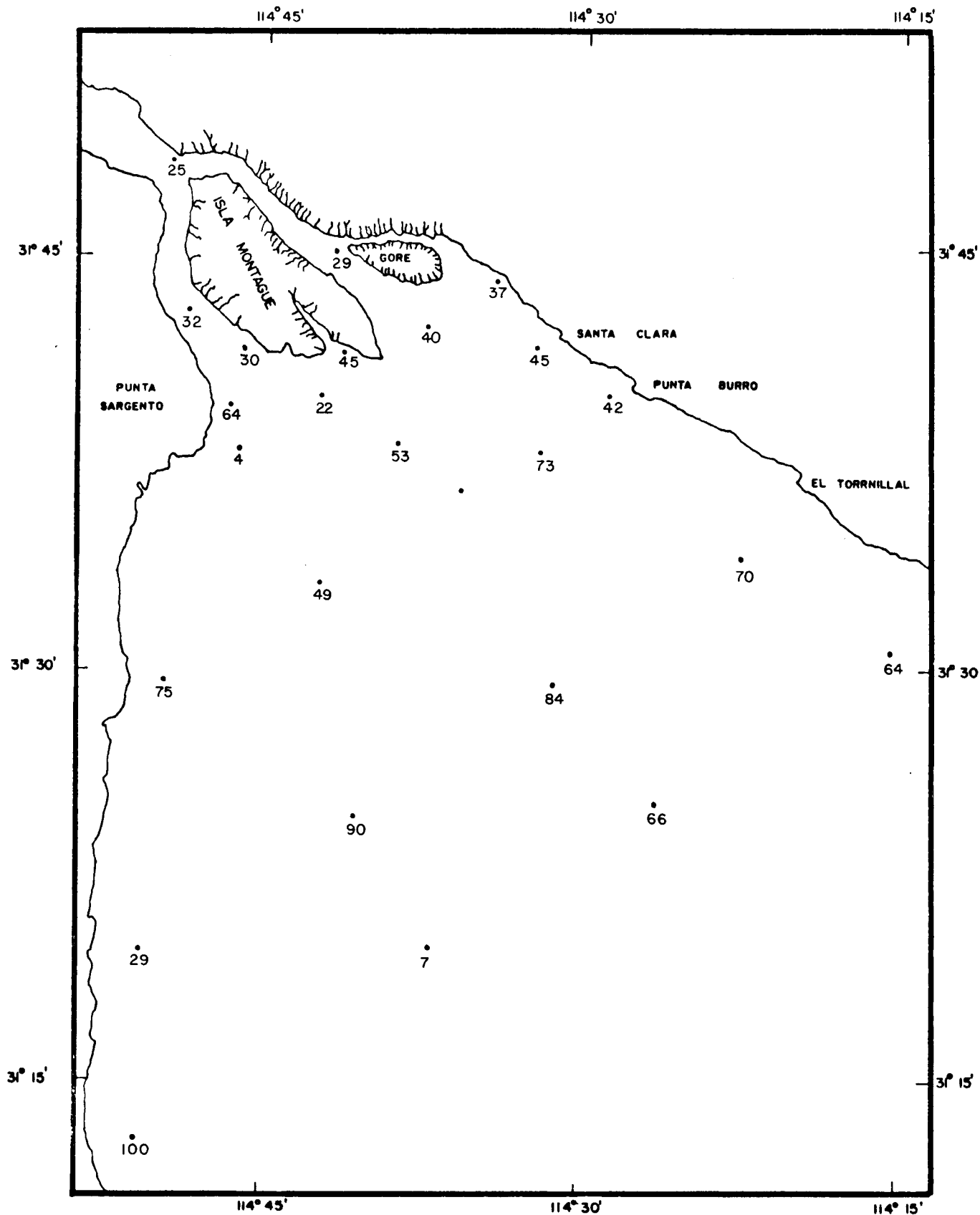

FIGURA 16. Distribución superficial de porcentaje de material menor a 5 micras. Mayo.

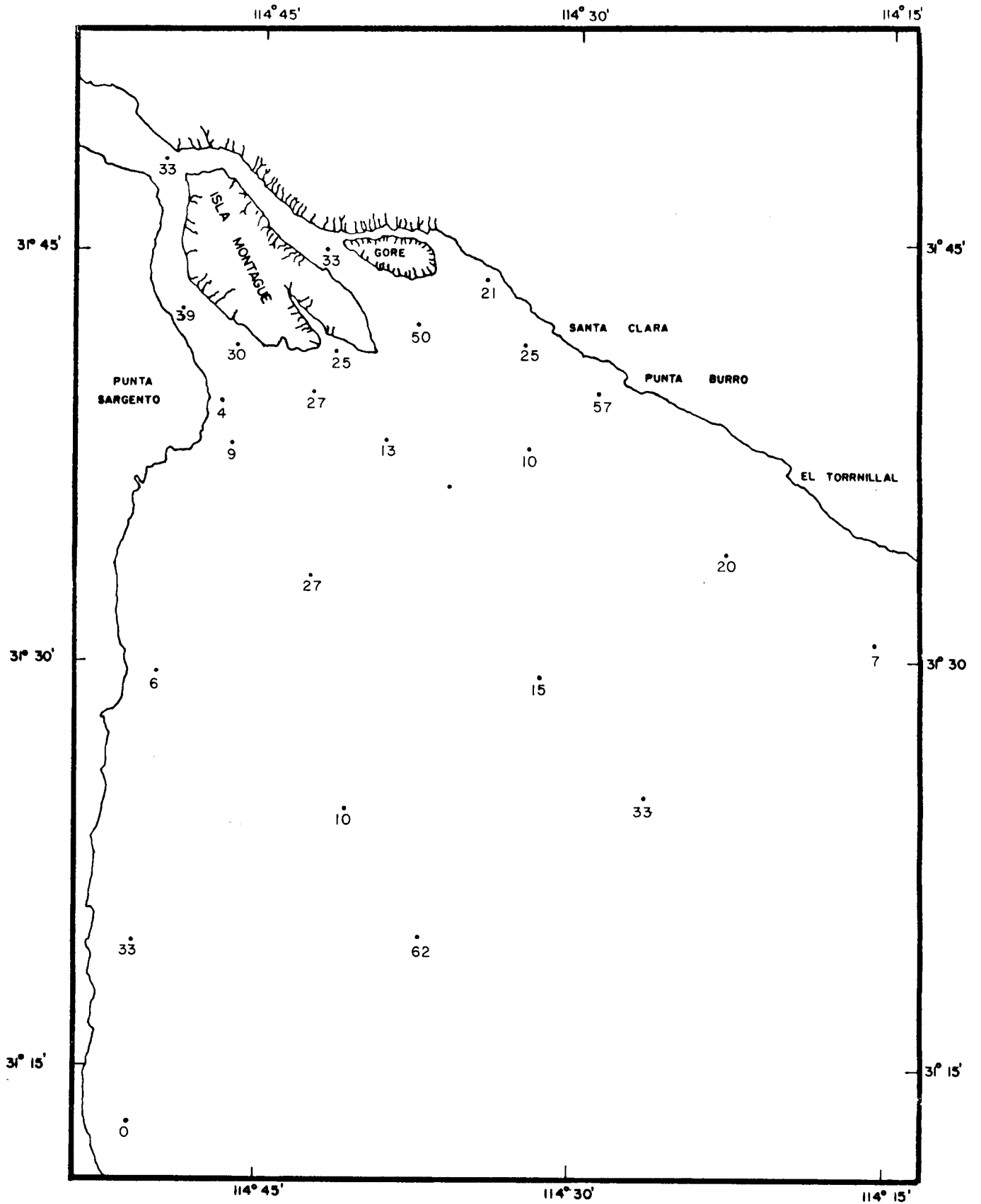

FIGURA 17. Distribución superficial de porcentaje de material mayor a 8 micras. Octubre.



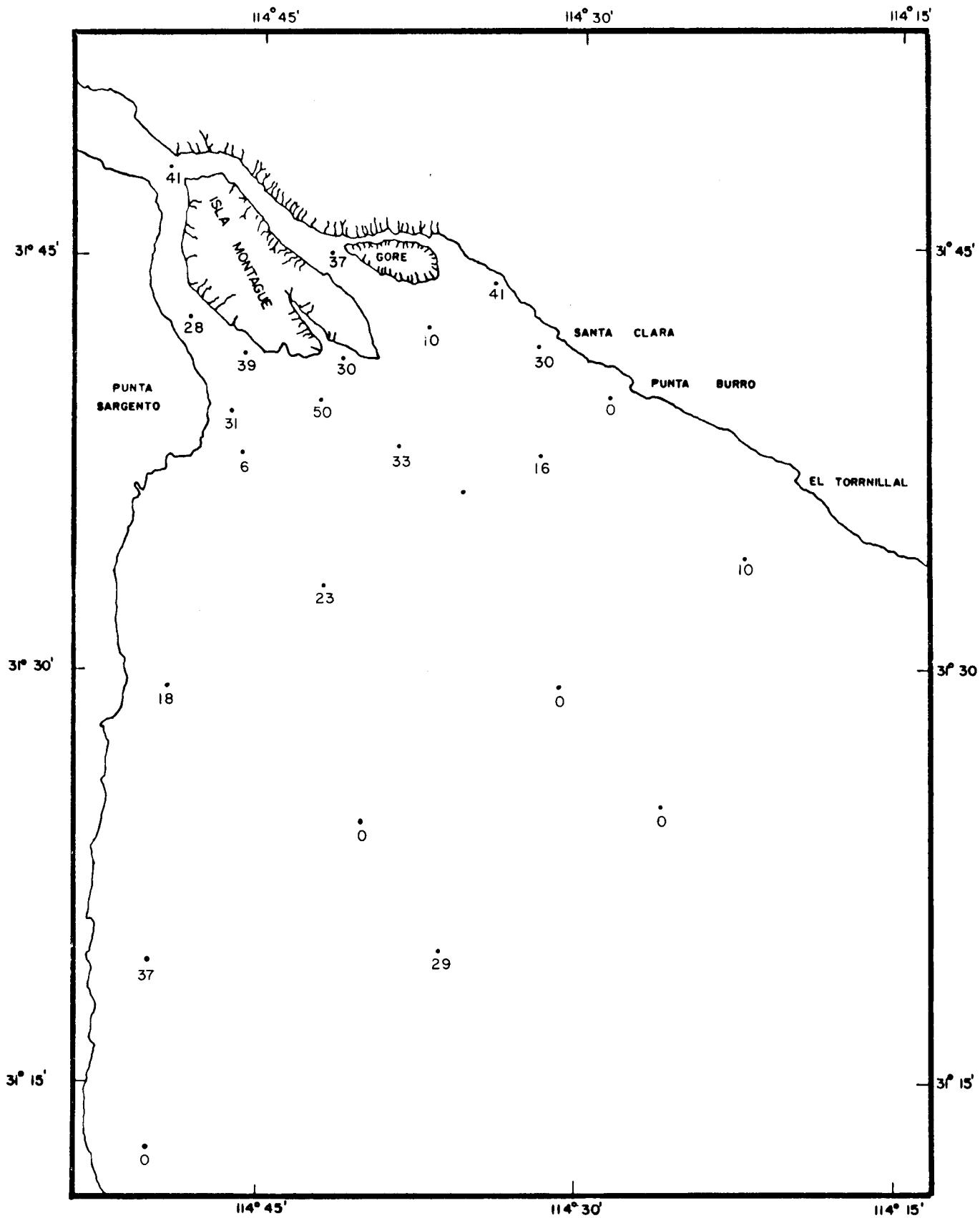

FIGURA 18. Distribución superficial de porcentaje de material entre 8 y 5 micras. Octubre.

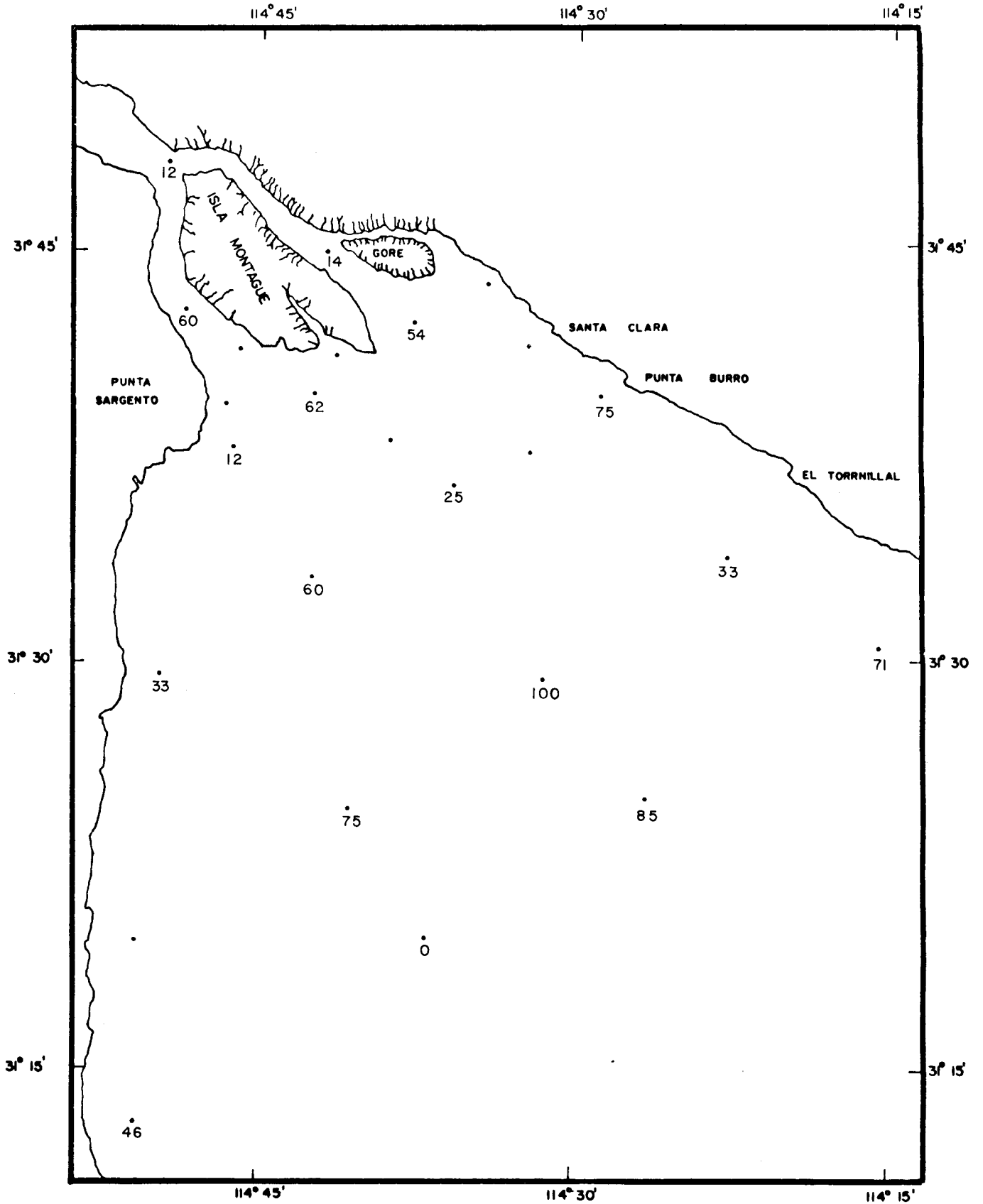

FIGURA 19. Distribución superficial de porcentaje de material menor a 5 micras. Octubre.

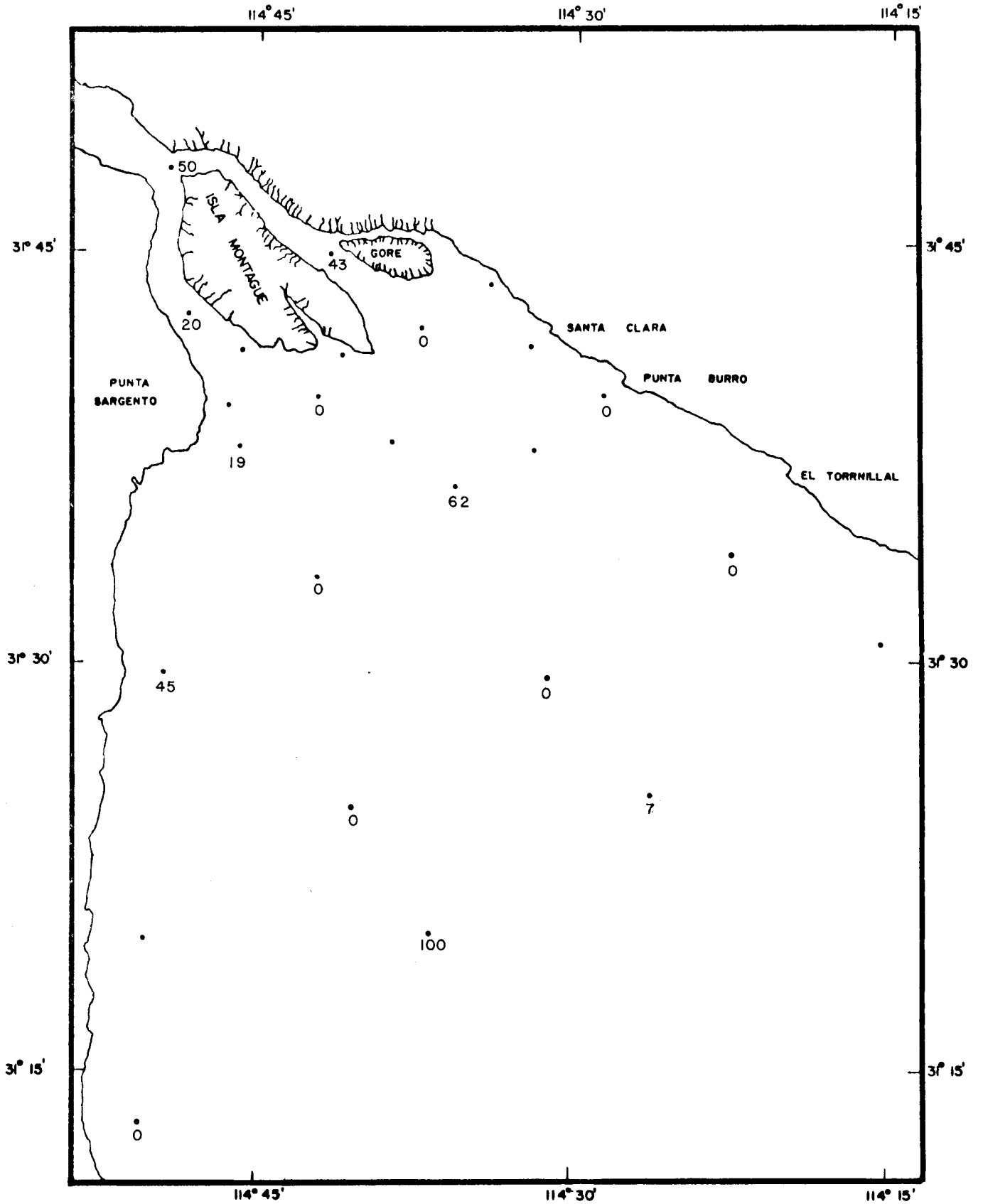

FIGURA 20. Distribución superficial de por ciento de materia orgánica. Octubre.

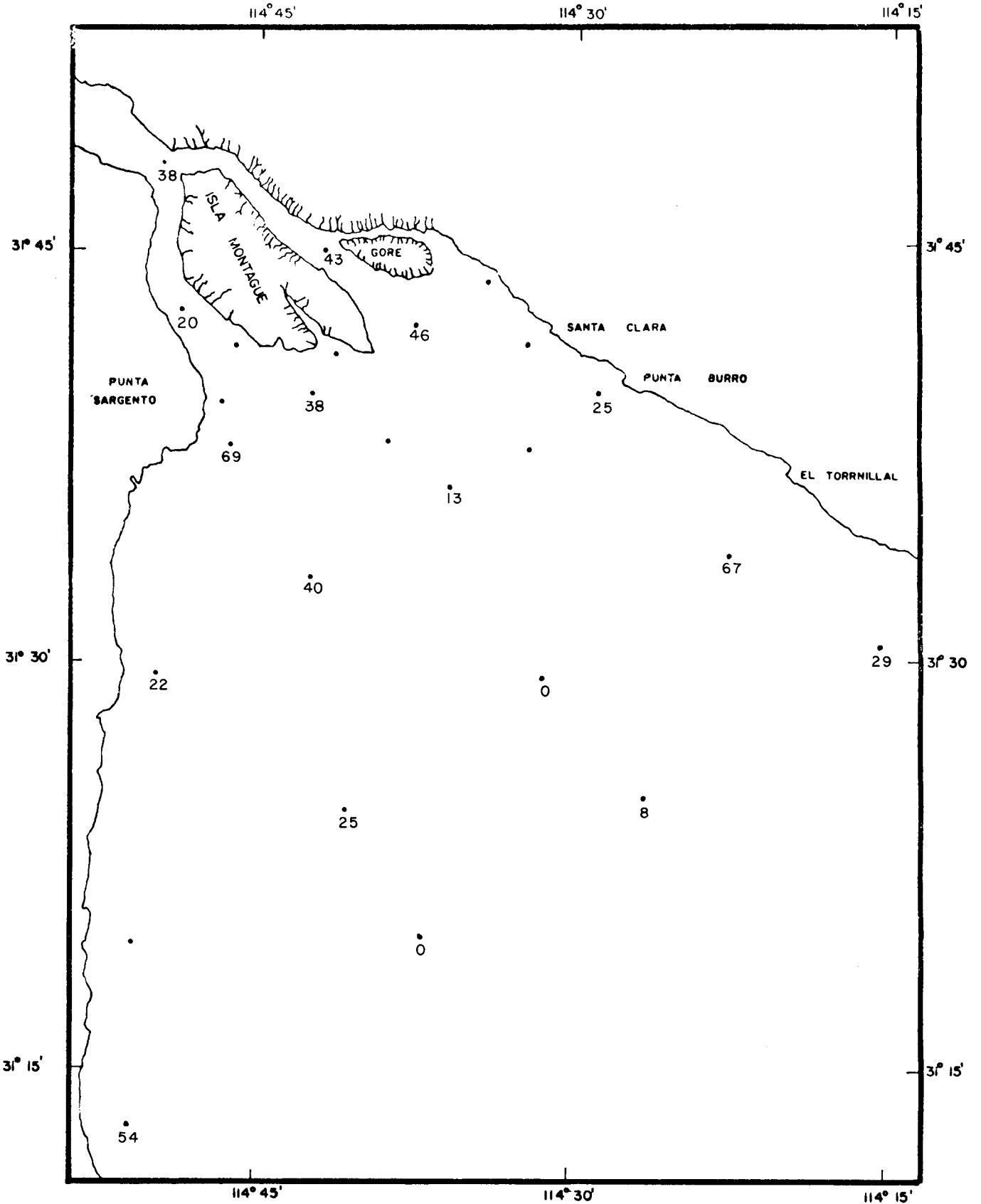

FIGURA 21. Variación diaria. Estudio del material en suspensión (mg/l) y la marea a lo largo de 24 horas en la Estación 24. Mayo.

En la distribución de superficie (Figura 9), se encuentran las mayores concentraciones de material hacia la región noroeste del área, encontrándose un valor máximo de 27 ppm en la Estación 7 y mínimos de 1 ppm en las Estaciones 16 y 17.

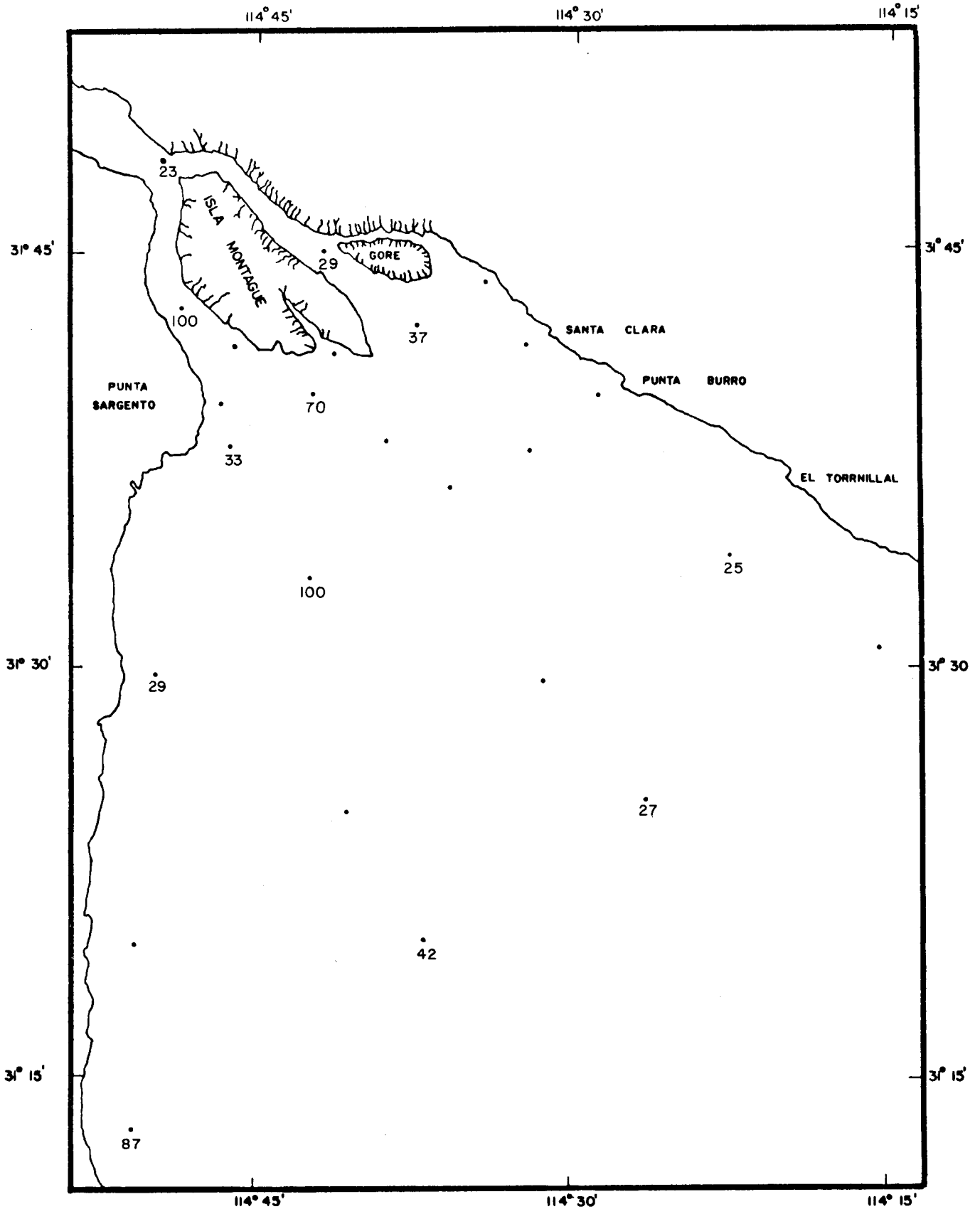
A los 5 m de profundidad (Figura 10), se encuentra un valor máximo de 37 ppm en la Estación 18 y un mínimo de 1 ppm en la Estación 16.

A los 10 m de profundidad (Figura 11), el valor máximo es de 9 ppm en la Estación 13 y un mínimo de 3 ppm en la Estación 16.

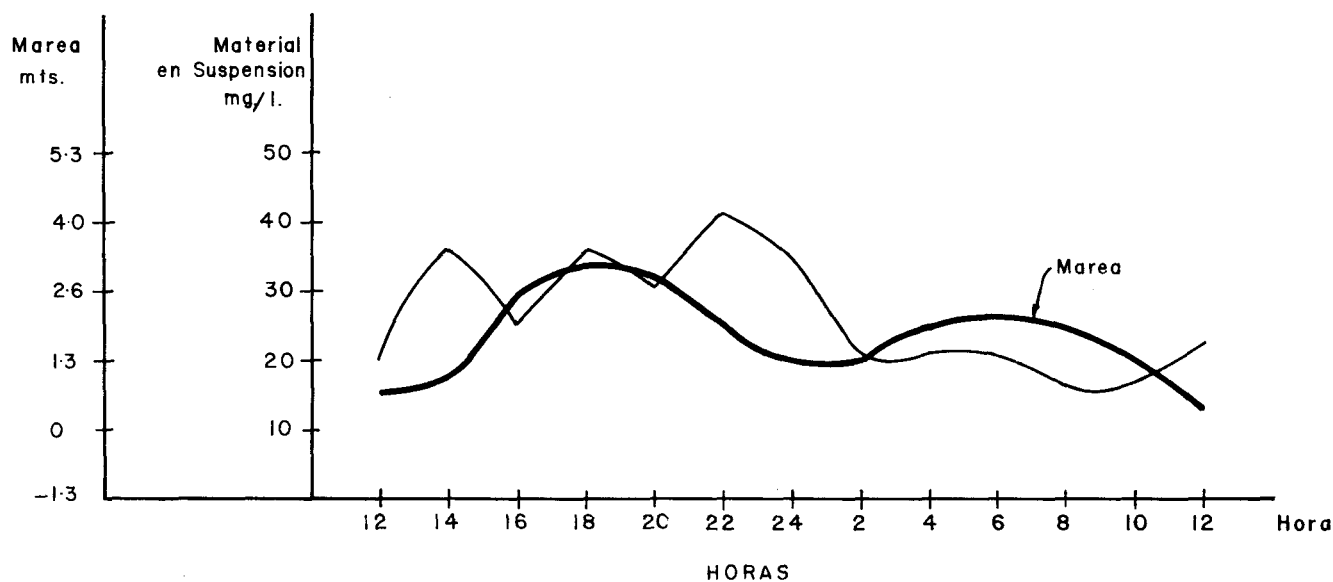
4. *Granulometría.* En la distribución superficial del mes de mayo (Figura 12), se nota en la zona noroeste un mayor porcentaje de material de tamaño mayor a 8 micras, mientras que en la zona norte y noreste se observan valores de tendencia contraria. En la parte sur, se encuentra gran irregularidad en los valores.

En la distribución superficial de octubre (Figura 13), se nota una considerable disminución en la cantidad de partículas mayores a 8 micras.

También se determinaron porcentajes del tamaño del material. En el mes de mayo, en porcentajes de partículas mayores a 8 micras (Figura 14), se nota en general una disminución hacia el norte del área. El valor máximo fué de 100% en la Estación 15, y el mínimo de 7% en las Estación 16.

En los porcentajes de partículas entre 8 y 5 micras (Figura 15), se observa bastante irregularidad en la distribución de los valores, notándose un máximo de 62% en la Estación 16 y un mínimo de 4% en la Estación 21.

Los porcentajes de material menor a 5 micras (Figura 16) se ven bastante reducidos, encontrándose un máximo de 50% en la Estación 5 y mínimos de 0 en varias estaciones del sur.

En la distribución de porcentajes de material mayor a 8 micras del crucero de octubre (Figura 17) se observa un valor máximo de 100% en la Estación 12 y un mínimo de 0 en la Estación 16.

En la gráfica de porcentajes de material entre 8 y 5 micras (Figura 18) se nota en general una disminución en los valores, encontrándose un máximo de 100% en la Estación 16 y un gran número de estaciones con valores 0. Para las partículas menores a 5 micras (Figura 19) se nota un decrecimiento de los valores en dirección sureste, teniendo un máximo de 67% en la Estación 11 y mínimos de 0 en las Estaciones 12 y 16.

5. *Materia orgánica.* Sólo se determinaron porcentajes de materia orgánica en las muestras obtenidas en el crucero de octubre (Figura 20). En general, la distribución de dichos valores es bastante irregular, se observan dos máximos de 100% en las Estaciones 4 y 8, y un mínimo de 23% en la Estación 3. Hay que hacer notar que las muestras fueron analizadas varios días después de ser tomadas, por lo que los resultados pueden haber sido afectados por la acción bacteriana.

## DISCUSIONES

Los muestreos no fueron llevados a cabo simultáneamente, y los parámetros medidos en este trabajo entre una y otra estación varían de acuerdo a las condiciones de marea, luz, temperatura, etc., por lo que los valores determinados no son de precisión. Con el fin de conocer este rango de variabilidad se llevó a cabo la medición de una variación diaria en la estación 24 durante el crucero de mayo (Figura 21), en la que se observa un cambio de 20 a 40 mg/l de seston en la misma estación.



FIGURA 22. Batimetría del área de estudio establecida por Thompson en 1965.

Una de las posibles razones por la que se encuentra mayor concentración de material en suspensión en la zona noroeste del área de estudio, puede ser la batimetría de la misma, ya que la topografía del fondo en la costa de Baja California es amplia y de pendiente suave, en contraste con la costa de Sonora cuya plataforma es mucho más estrecha y abrupta (Figura 22).

En la gráfica elaborada por Thompson (1965), de la distribución superficial de los sedimentos de fondo en la misma área (Figura 23), claramente se observa que los sedimentos finos (limos y arcillas), se encuentran en la costa noroeste, mientras que en la costa sureste, el sedimento es más grueso (arena), lo cual se correlaciona con los resultados de este estudio.

El examen de la gráfica del estudio de la variación diurna (Figura 21), nos muestra varias cosas. Se puede observar claramente que existe un rango de variación bastante grande (20–40 mg/l), se nota que el máximo de turbidez se obtiene cuatro horas antes de la marea baja. Estos elementos hacen pensar que existe una masa de agua turbia que se desplaza con el flujo y reflujo de las mareas de norte a sur. Este fenómeno bien conocido en los estuarios fué llamado “tapón lodoso” (Berthois, 1945), y hasta ahora no ha sido mencionado en aguas marinas.

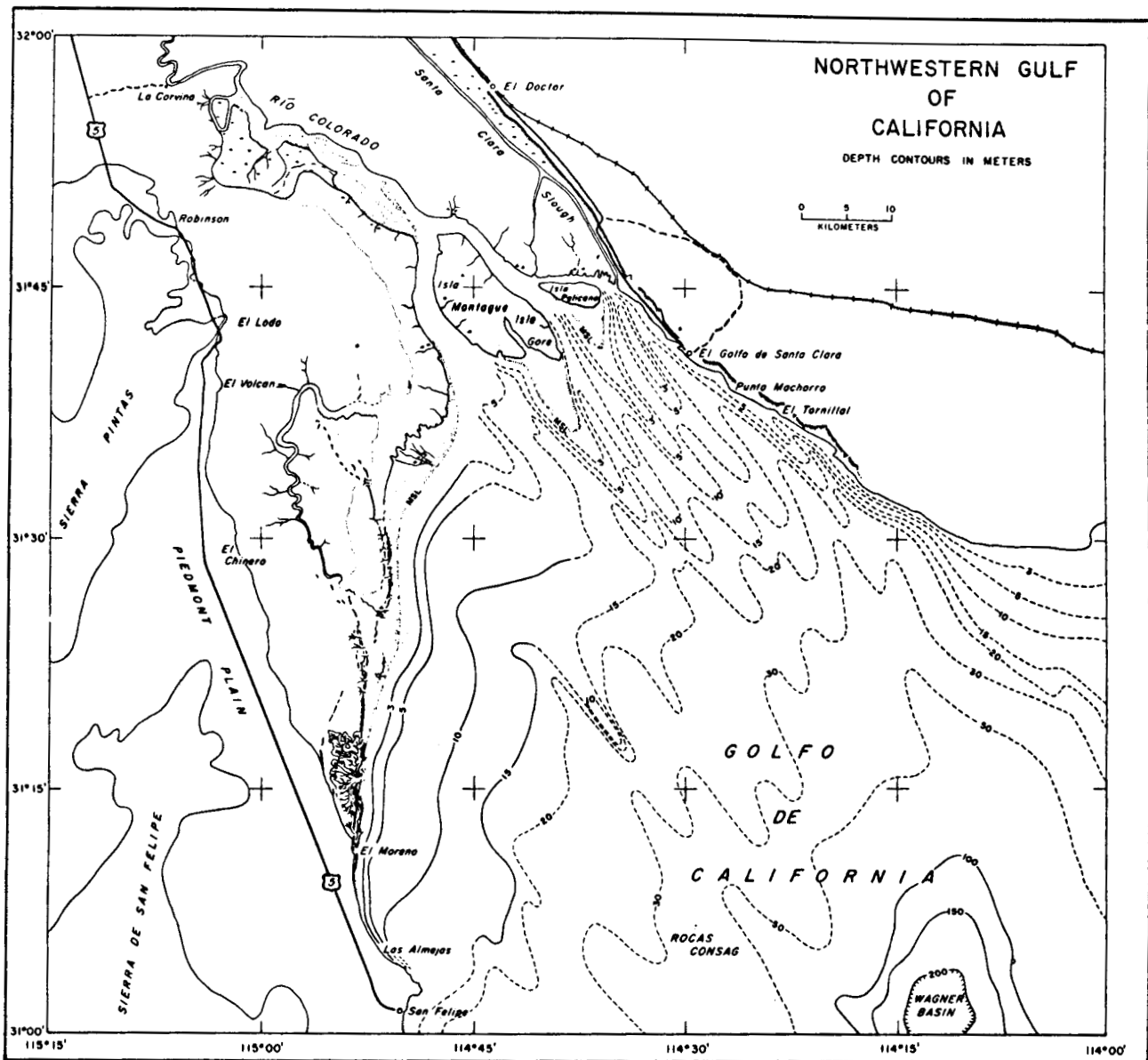
Hay que tomar en cuenta que en nuestra área de estudio los agentes dinámicos no sólo son el flujo y reflujo de las mareas, sino también la corriente neta que forma en esta región del golfo, un giro en sentido contrario a las manecillas del reloj, lo que hace que



FIGURA 23. Distribución superficial de sedimentos de fondo en el área de estudio, establecida por Thompson (1965).

este "tapón lodoso" se desvíe hacia el oeste, por lo que la zona de mayor turbidez se encuentra siempre situada en el extremo noroeste del área.

Se debe considerar también el efecto del oleaje sobre el fondo. Es muy difícil determinar exactamente hasta que profundidad actúa la ola, algunos autores citan un valor de 20 veces la altura de la ola, pero otros consideran que a una profundidad igual a la semilongitud de onda y aún a la de la longitud de onda, la acción de la ola no se deja sentir. Para determinar la máxima acción de la ola sobre determinada profundidad, bastará conocer la máxima velocidad de las partículas situadas a esa profundidad. Con ello se puede saber, por ejemplo, si el fondo, cuya naturaleza es conocida, puede ser socavado por la ola considerada (Iribarren, 1954).

Pero de una manera general, se considera como

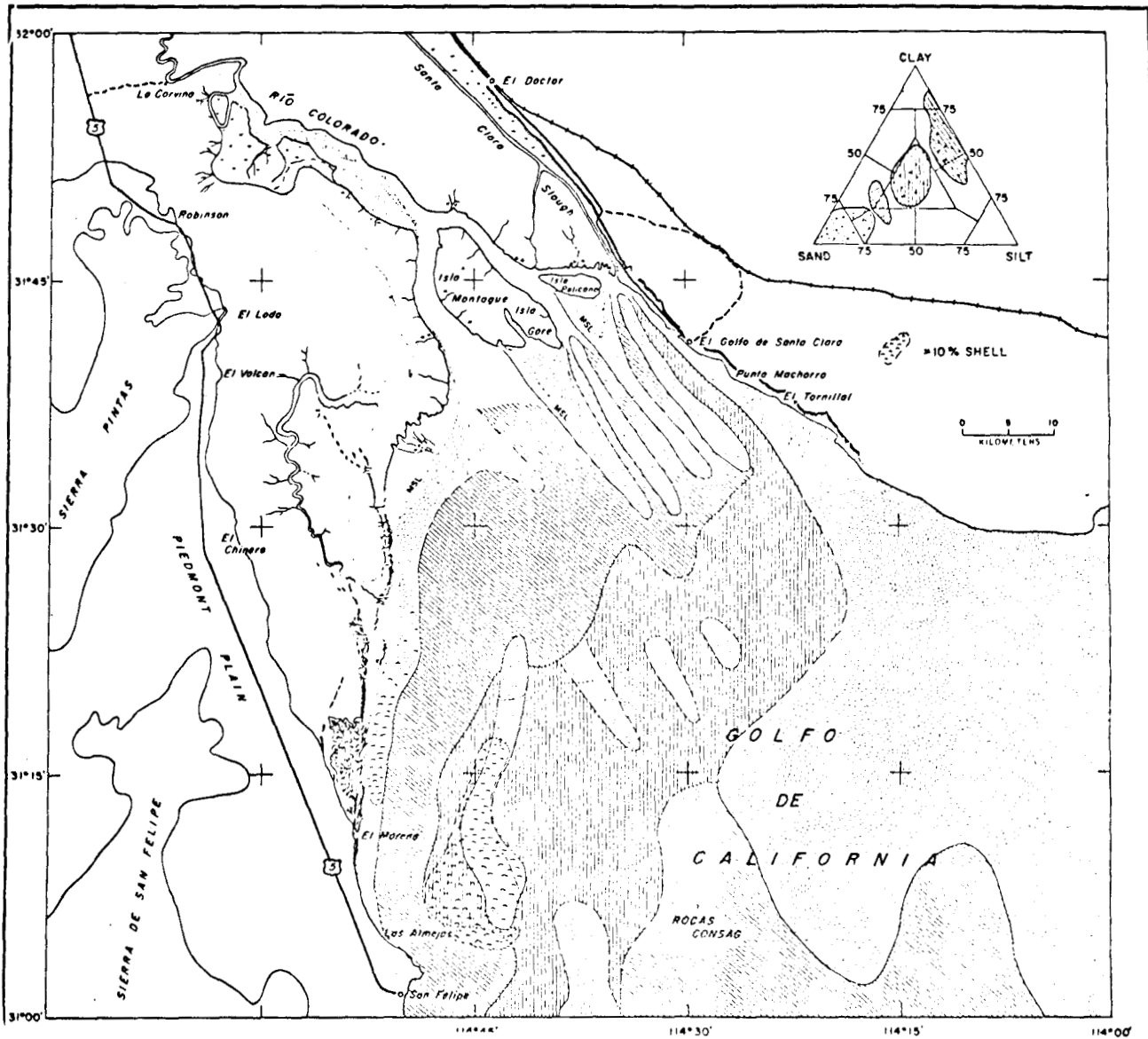
profundidad máxima a donde la ola todavía tiene efecto, la semilongitud de la misma (de Labra, comunicación personal).

La altura de las olas en esta área no es muy grande, según observaciones visuales durante los cruces, varió entre 0.2 y 0.6 m. La longitud de onda de las olas no fué observada, por lo que no se puede correlacionar con la acción del oleaje sobre el fondo. Sin embargo, basándose en la altura de las olas, la baja batimetría y el fondo lodoso de la costa noroeste, se puede considerar al oleaje como un agente dinámico de importancia en la formación de la turbidez.

Si como se dijo anteriormente, el Río Colorado ya no aporta material al Golfo de California, se puede pensar que el origen de las partículas que producen la turbidez sean los limos y las arcillas depositadas durante la formación del delta. La acción combinada

de la corriente neta, el flujo y reflujo de las mareas y el oleaje, provocan un levantamiento de las partículas del fondo y posteriormente debido a estos mismos factores dinámicos una permanencia en suspensión de las partículas menores. Considerando el sentido de la corriente, se puede pensar que la zona este (sur de Santa Clara), es de erosión y que la zona oeste (norte de San Felipe), es de depositación, este fenómeno se observa fácilmente en una vista aérea, en la que se nota la formación de un tómbolo submarino en la prolongación de la Isla Montague con el extremo dirigido hacia el oeste, y otro al norte de San Felipe con la punta dirigida hacia el sur.

Al observar los parámetros fisicoquímicos determinados en los mismos cruceros, se establecen varias correlaciones con la turbidez. Durante el crucero de mayo, las máximas temperaturas superficiales se encuentran en el extremo noroeste en la misma zona en donde las concentraciones de material en suspensión son mayores, tal vez por la mayor absorción de la energía solar por parte de las partículas y, también debido a que la turbidez no permite el paso de la luz haciendo que se absorba en los primeros centímetros, calentando las aguas superficiales. En el mismo crucero se observan también las máximas salinidades en el extremo noroeste, lo cual está en relación directa con la temperatura, ya que al aumentar la evaporación se incrementa la salinidad.

Los valores de oxígeno disuelto del mismo mes muestran una distribución contraria, esto es, disminuyen hacia el noroeste y aumentan hacia el sureste. Estos valores mínimos en el noroeste pueden ser debidos al efecto que tienen las altas temperaturas disminuyendo la solubilidad del oxígeno, sin embargo, observando los valores de porcentaje de saturación (disminuyen hacia el noroeste), se ve claramente que existen otros factores además de la temperatura y la salinidad que afectan a la concentración de oxígeno disuelto, uno de estos factores es la presencia de la turbidez. En los análisis cuantitativos de plancton, se observa que los valores máximos también se encuentran concentrados en la región noroeste del área (Farfán, comunicación personal). En este extremo noroeste, en donde los valores de oxígeno disuelto son menores, existe un gran consumo del mismo por respiración, en parte por el material en suspensión (zooplancton y bacterias que actúan en la descomposición de la materia orgánica), y en parte por la gran cantidad de larvas y estadios juveniles de peces y crustáceos que encuentran protección y alimento en las áreas de mayor turbidez (Guevara, comunicación personal).

Los parámetros hidrológicos determinados en el crucero de octubre en general no presentan tanta correlación con la turbidez, sin embargo, las distribuciones de temperatura y salinidad sí se ven

ligeramente incrementados en dirección noroeste.

Entre las gráficas de distribución del material en ppm determinada con el turbidímetro en superficie (Figura 9), y la de mg/l de seston del mes de mayo (Figura 5), se observa una gran diferencia en los valores, de 15 ppm a 100 mg/l en el noroeste y de 1 ppm a 10 mg/l en el sureste, lo cual se estima se debe a la cantidad de plancton y materia orgánica (detritus), ya que el turbidímetro sólo mide la turbidez debida a partículas de  $\text{SiO}_2$ , pero no determina material orgánico o de otra naturaleza. O sea que de la cantidad de material en suspensión medida en mayo, aproximadamente entre el 85 y el 90% era materia orgánica.

En cuanto a la granulometría, en mayo (Figura 12) se nota que hay tres poblaciones diferentes de turbidez, una situada alrededor de la Isla Montague, en donde la mayoría de las partículas son mayores a 8 micras, una segunda zona noreste con tendencia contraria y en la parte sureste una tercera en donde no se muestra una tendencia marcada. En octubre (Figura 13), se nota la desaparición de la segunda población y sólo se observan dos, una en el noroeste que abarca los lugares de las poblaciones 1 y 2 de mayo, y una segunda en donde la distribución se presenta irregular, pero se sigue notando la desaparición de las partículas mayores a 8 micras, por lo que se puede pensar que la variación de cantidad de seston de mayo a octubre se debe a partículas mayores a 8 micras.

Como fuente del material en suspensión además de los sedimentos del fondo ya considerados, hay que tomar en cuenta los sedimentos acarreados por el viento del continente, sobre todo considerando que la costa de esta área es árida y de escasa humedad. Hay que hacer notar que el mayor porcentaje del material en suspensión es materia orgánica, el origen de la misma no se puede determinar ya que para ello hace falta realizar estudios específicos de materia orgánica en el área, pero lo que sí se sabe es que establece en el área condiciones ambientales muy especiales ya que constituye el alimento de gran cantidad de organismos que habitan en la misma (Guevara, comunicación personal).

Deben haber todavía otros parámetros que afectan a este fenómeno, como la temperatura y salinidad que cambian las condiciones de densidad del agua y que por lo tanto intervienen en la distribución vertical de la turbidez.

## CONCLUSIONES

Hay que considerar que los resultados de este estudio no son exactos, ya que como se mencionó anteriormente, las muestras no fueron colectadas en una forma simultánea, sin embargo se pueden hacer las siguientes conclusiones:

La presencia de material en suspensión en el área de estudio es de carácter constante.

Existe un gradiente de concentración descendente

del noroeste al sureste del área.

Este material tiene porcentajes sumamente altos de materia orgánica, por lo que puede ser considerado como de gran importancia como alimento para diferentes organismos marinos.

La dinámica de la corriente neta sin contar el flujo y reflujo de las mareas es el agente principal de la distribución del material.

De una manera general existe un movimiento controlado por las mareas de noroeste a sureste. Pero las corrientes y las mareas no son los únicos factores dinámicos de la turbidez, sino también el efecto del oleaje sobre el fondo.

El examen de los datos biológicos nos muestra que existe similitud entre la distribución de la turbidez y la del plancton, larvas y estadios juveniles de peces y crustáceos, lo que nos hace pensar que este parámetro actúa directamente sobre la distribución de los organismos.

#### BIBLIOGRAFÍA

Alvarez, Sanchez G. 1973. Noticia del Río Colorado de la Baja California. *CALAFIA*, 2(2): 22-31.

Gayman, W. 1969. Turbidity in the extreme northern Gulf of California: 88-91. *In* Environmental impact of brine effluents on Gulf of California. Saline Water Res. and Dev. Prog. Rept., (387): 1-207.

Green, C. R. 1969. The northern Gulf of California: A synopsis based on available information. B. Meteorological conditions: 7-15. *In* Environmental impact of brine effluents in Gulf of California: Saline Water Res. and Dev. Prog. Rept., (387): 1-207.

Iribarren, R. 1954. Obras Marítimas. Oleaje y Diques. Editorial Dossat, S. A. Madrid: 85-88.

Mathews, J. B. 1969. Tides in the Gulf of California: 41-50. *In* Environmental impact of brine effluents in Gulf of California. Saline Water Res. and Dev. Prog. Rept., (387): 1-207.

Roden, G. I. 1958. Oceanographic and Meteorological aspects of the Gulf of California. *Pacific Science*, 12(1): 941-965.

———. 1964. Oceanographic aspects of Gulf of California. *In* T. H. van Andel and G. G. Shore Jr., eds., *Marine Geology of the Gulf of California*, Amer. Assoc. Petroleum Geologists, Memoir 3: 30-58.

Schreiber, J. F. 1969. The northern Gulf of California: A synopsis based on available information. A. Geographical and geological features: 3-6. *In* Environmental impact of brine effluents on Gulf of California. Saline Water Res. and Dev. Prog. Rept., (387): 1-207.

Thompson, R. W. 1965. Tidal Flat Sedimentation on the Colorado River Delta, northwestern Gulf of California. University of California, San Diego. Scripps Institution of Oceanography. (unpublished Ph.D. dissertation), 245 p.

———. 1969. Tidal currents and general circulation: 51-55. *In* Environmental impact of brine effluents on Gulf of California. Saline Water Res. and Deve. Prog. Rept., (387): 1-207.

Zeitzschel, B. 1970. The quantity, composition and distribution of suspended particulate matter in the Gulf of California. *Mar. Biol.*, 7(4): 305-318.



## **C. SCIENTIFIC CONTRIBUTIONS**



# ON BIOLOGY OF THE MARKET SQUID, *LOLIGO OPALESCENS*, A CONTRIBUTION TOWARD THE KNOWLEDGE OF ITS FOOD HABITS AND FEEDING BEHAVIOR

Anatole S. Loukashkin  
California Academy of Sciences  
San Francisco, California

## ABSTRACT

Out of 1,000 stomachs of the market squid, *Loligo opalescens*, from the waters of southern and central California collected in different months and different years, only 33.1% contained food in various quantities, while 66.9% were empty. The amount of food in the stomachs varied from full stomach capacity to less than 1/8 capacity. Dominating food items were found to be crustaceans (42.0%), indeterminate fleshy material and fluid matter (24.8%), fish (19.6%) and polychaete worms and miscellaneous material (13.6%).

## INTRODUCTION

Between November 1970 and June 1974, twenty-three collections of stomachs of market squid, *Loligo opalescens* Berry, totaling 1,000, were made in the waters of central and southern California. Of this number four winter collections were made in central California in November and December 1970, January 1971, and March 1972, yielding 221 stomachs. Ten summer collections from the same area were made in July 1971, June and July 1972, May 1973, and June 1974, yielding 511 stomachs. In southern California eight winter collections composed of 180 specimens were made in January 1971, October, November, and December 1973, and only one summer collection of 88 squid stomachs was made in June 1974.

## ACKNOWLEDGEMENTS

Most of the material listed was obtained through the efforts and friendly cooperation of members of the California Department of Fish and Game: Doyle E. Gates, Herbert W. Frey, J. R. Raymond Ally, James Hardwick, and Jerome D. Spratt; and in the National Marine Fisheries Service in La Jolla, Susume Kato. To all of these the author expresses his sincere gratitude and appreciation.

## RESULTS

Unfortunately, the 1,000 specimens collected contained over 66% empty stomachs (Table 1). Therefore the limited quantitative data presented here are considered by me only as a preliminary study to serve as a guideline toward further investigations and more conclusive results.

Of the stomachs containing food or food remains from either collecting area, most were filled to no more than 1/4 capacity and often far below that (Table 2). Only 57 out of 331 stomachs were completely filled, including 29 "gorged" (when upon cutting the abdomen, the stomach would burst). As to the empty stomachs in the collections, most represented material from central California (Monterey Bay to Point Conception), both summer and winter collections. The ratio between filled and empty stomachs collected in southern California is just about equal, regardless of collecting season.

Crustaceans constitute a major item in the squid's diet, with shrimp (such as *Sergestis* sp.) and shrimp-like euphausiids as dominant forms (Table 3). Fishes are next on the menu of squid, and the third place is taken by pelagic worms. Cannibalistic tendencies of squid (preying upon very young specimens of their own kind) were noted three times in collections from central California, and three times in collections from southern California.

## DISCUSSION

During my participation in research cruises of the M/V ALASKA in California and Mexican territorial waters between 1958 and 1974, there were numerous occasions to observe schools of squids entering the illuminated zone at nightlight stations in the open sea. Sometimes these schools were engaged in very active pursuit of the organisms, such as young fish, euphausiids, or nereid worms concentrated under the light of the 1,000 watt incandescent electric lamp.

TABLE 1  
Stomachs of Market Squid, *Loligo opalescens*, Collected during 1970, 1971, 1972, 1973, and 1974, by Region and Season.

Season	Central California			Southern California			Both regions		
	Cont. food	Empty	Total	Cont. food	Empty	Total	Cont. food	Empty	Total
Summer.....	149	362	511	46	42	88	195	404	599
Winter.....	46	175	221	90	90	180	136	265	401
Total.....	195	537	732	136	132	268	331	669	1,000
Percentages.....	26.6	73.4	100.0	50.8	49.2	100.0	33.1	66.9	100.0

TABLE 2

**Stomachs of the Market Squid, *Loligo opalescens*, Collected during 1970, 1971, 1972, 1973, and 1974, by Region, Season, and Food Contents as Related to Stomach Capacity.**

Region	Season	Contents in relation to stomach capacity*							Total	Empty	All
		Full	$\frac{3}{4}$	$\frac{1}{2}$	$\frac{1}{4}$	$\frac{1}{8}$	$< \frac{1}{8}$				
Central California	Summer	23 <sup>a</sup>	2	15	50	32	27	149	362	511	
	Winter	5	8	5	3	8	17	46	175	221	
Total		28 <sup>a</sup>	10	20	53	40	44	195	537	732	
Percentages		14.4	5.1	10.2	27.2	20.5	22.6	100.0	--	--	
Southern California	Summer	12 <sup>b</sup>	3	6	6	8	11	46	42	88	
	Winter	17 <sup>c</sup>	13	8	10	18	24	90	90	180	
Total		29 <sup>d</sup>	16	14	16	26	33	136	132	268	
Percentages		21.3	11.8	10.3	11.8	19.1	25.7	100.0	--	--	
Grand total		57 <sup>e</sup>	26	34	69	66	79	331	669	1,000	
Percentages		17.2	7.8	10.3	20.9	20.0	23.8	100.0	--	--	

\* Explanation of symbols: <sup>a</sup> including 19 "gorged" or extreme capacity.  
<sup>b</sup> including 6 "gorged" or extreme capacity.  
<sup>c</sup> including 4 "gorged" or extreme capacity.  
<sup>d</sup> including 10 "gorged" or extreme capacity.  
<sup>e</sup> including 29 "gorged" or extreme capacity.

On several occasions, when the blanket net was used for getting a sample from the fish school under the light, the catch included a number of adult squids of large sizes, and some of them were found holding in their arms a fish 8 to 10 inches long (sardine or jack mackerel). It looked like a head-on collision: The squid's arms were found entangling the head of the fish so tightly that mouth and gill covers were unable

to open, thus causing the fish to die from asphyxiation.

I did not have an opportunity to observe feeding behavior of squid kept in captivity; however, a few comments on this subject by earlier contributors are given below.

Hardy (1956) refers to observations made by Anna M. Bidder (1950) on feeding behavior of the European *Loligo* in an aquarium. According to her, the fish is always "seized behind the head and held obliquely with the tail uppermost and is so carried until the head is bitten off and dropped . . . The trunk of the fish is then held horizontally in the arms, in line with the body . . . (and then) . . . the squid bites through the fish from head to tail by a series of transverse bites . . ." The consumption of a meal may last from 15 to 20 minutes, or even longer, and by this time the stomach may expand to  $\frac{1}{3}$  of the length of the mantle and  $\frac{1}{2}$  its width. W. Gordon Fields (1965) described his observations of feeding behavior of the market squid, *L. opalescens*, in a holding tank, using brokenback shrimp, *Spirontocaris* sp., as its prey. After a shrimp was caught, it was immediately held to the mouth and eaten in several bites, dropping rejected parts to the bottom. While eating the squid would continue to catch more shrimps with its tentacles. Fields also mentions that squids in captivity often attack one another; "in cases where an animal has unaccountably disappeared, its entire consumption by other members of the school has been considered likely."

As stomach contents attest, the squid feeds mainly upon free and actively swimming animals, such as fish and crustaceans. Food in the stomach was usually found to be of one type: it was either crustaceans, or fish, or polychaetes. However, this rule was not

TABLE 3

**Frequency of Occurrence of Dominating Food Items in 331 Filled Stomachs of the Market Squid, *Loligo opalescens*, Collected in Central and Southern California during 1970, 1971, 1972, and 1974.**

Description	Central California (numbers)	Southern California (numbers)	Both	
			(numbers)	(percent)
1. Crustacean remains, indeterminate	88	19	107	32.3
2. Crustacean remains (larvae)	0	8	8	2.4
3. Crustacean remains (Euphausiids)	10	11	21	6.4
4. Crustacean remains (Sergestid shrimp)	3	0	3	0.9
Subtotal	101	38	139	42.0
5. Fish parts and fish remains	30	35	65	19.6
6. Fleishy material, indeterminate	35	36	71	21.5
7. Fluid matter, indeterminate	11	0	11	3.3
8. Polychaete worms remains	8	24	32	9.7
9. Pelagic worms remains(?)	1	0	1	0.3
10. Young squid remains	3	3	6	1.8
11. Young octopus remains	5	0	5	1.5
12. Part of unidentified animal	1	0	1	0.3
Subtotal	94	98	192	58.0
Total	195	136	331	100.0
Percentages	58.9	41.1	100.0	--



FIGURE 1. Squid stomachs, natural size. Upper photos (left to right): two empty stomachs (no. 1552, 1553), a stomach about  $\frac{1}{4}$  filled (no. 1568), and a stomach about  $\frac{1}{2}$  filled (no. 1561).

Lower photo, "gorged" stomach of squid no. 1554, collected by James Hardwick near Fisherman's Breakwater, Monterey Bay, February 15, 1971. Male specimen, body length 300 mm.

infrequently broken; two or even three kinds of food in various proportions sometimes were found. During the spawning season almost all female stomachs were found empty. Most of the male stomachs at this period also indicate a tendency to feed only sparingly. Well filled stomachs were rare. Phillips (1960) states, "Numbers of squid have been noted dead or in dying condition following spawning"—an observation that may be relevant in this connection.

The identification of food items found in the squid's stomach contents presents a difficult task even for the experienced microscopist, because this animal does not swallow its prey intact, as do most of the fishes. Instead, it thoroughly dismembers it; heads are removed, appendages are almost never found intact. What the investigator finds under the

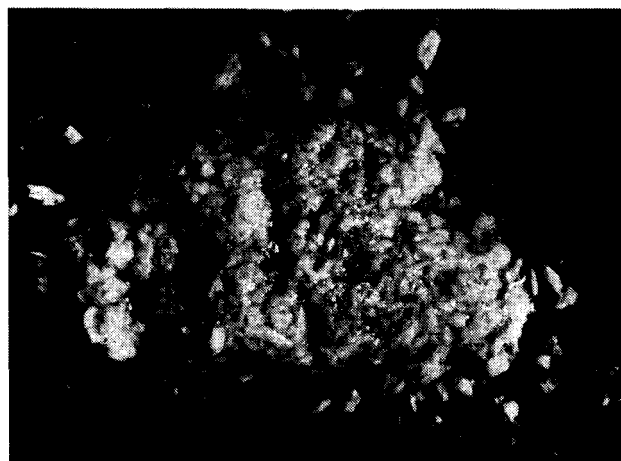

FIGURE 2. Contents of "gorged" stomach shown above, consisting almost entirely of fragmented euphausiids. All five specimens of squid were of the same body length within a few mm.

microscope are very tiny bites of flesh, vertebrae, scales, parts of carapace or fish bones, crustacean eyes, along with digestive fluid, oil, and small lumps of grease.

## REFERENCES

- Bidder, Anna M. 1950. The digestive mechanism of the European squids. *Quart. J. of Microscopical Sci.*, 91: 1-43.
- Fields, W. Gordon. 1965. The structure, development, food relations, reproduction, and life history of the squid *Loligo opalescens* Berry. *Calif. Dept. of Fish and Game, Fish. Bull.*, (131): 1-108.
- Hardy, Alister C. 1956. *The Open Sea. Its Natural History: The World of Plankton.* Houghton Mifflin Company, Boston, 335 p.
- Phillips, J. B. 1960. Squid. pp. 21-31. In *California Ocean Fisheries Resources for the year 1960.* Calif. Dept. Fish and Game, Sacramento.

# DEEP SCATTERING LAYERS: PATTERNS IN THE PACIFIC

Sargun A. Tont

Scripps Institution of Oceanography  
University of California, San Diego  
La Jolla, California 92093

## ABSTRACT

The daytime depth of the deep scattering layers in major biotic regions of the Pacific Ocean are analyzed and found to be correlated with light levels, although at some locations a sharp temperature gradient seems to inhibit a particular layer from migrating to the surface. O<sub>2</sub> minimum layer seems to have no effect on the behavior of the layers. The layers have been classified as migratory, semi-migratory and stationary.

## INTRODUCTION

Ever since deep scattering layers (DSL) were discovered in 1948, they have been investigated extensively. The majority of these studies may be divided into two main categories: (1) the composition of the layers, and (2) the response of the layers to various stimuli such as light and temperature.

Deep scattering layers have been observed in almost every part of the oceans except the Antarctic, and since there is not merely a single species of vertically migrating organisms or a distinct fauna which covers such a range, one can then assume that the composition of the layers may differ from location to location. Samples of the DSL organisms show differing compositions (Barham, 1957). At present, there is not enough information to group and compare the DSLs according to their biological composition; nor do sufficient data exist to ascertain whether a single stimulus, such as solar irradiance, may account for the layer movements in every region of the Pacific Ocean.

An approach for comparing the characteristics of one layer of unknown composition with those of another layer is to make use of knowledge acquired by investigations not necessarily related to DSL studies. Such an attempt was made by Beklemishev (1964) who divided the Pacific Ocean into 17 major biotic regions, the boundaries of which were determined on the basis of net tows as well as water masses and currents. Implicit in this approach is that the distinctions apply to the DSL as well.

McGowan (1974) proposed other biogeographical regions, based on the distribution of a variety of planktonic and nektonic species, which significantly differ from those proposed by Beklemishev. McGowan's classifications of major biogeographical regions are used throughout this study (Figure 1).

DSL distribution in the California Current region is also included in this study even though this region is not considered as a major biotic region by

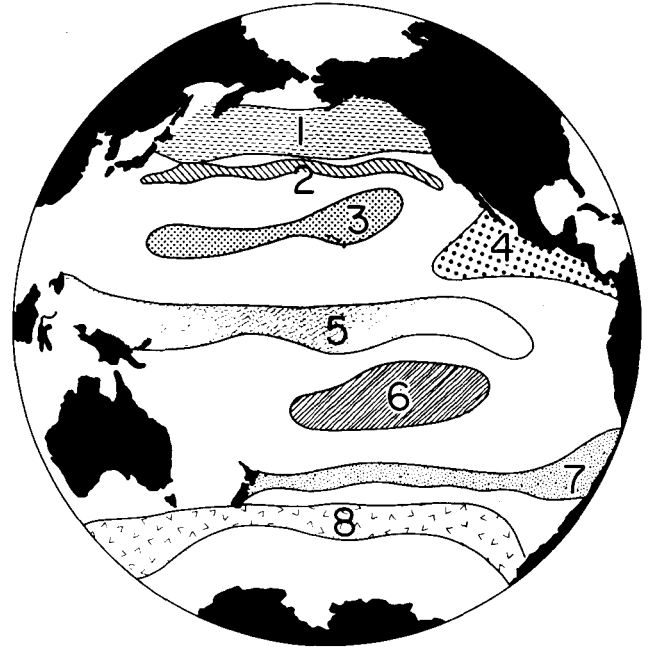

FIGURE 1. Patterns of the basic (100% "core" regions) biotic provinces of the oceanic Pacific. Redrawn from McGowan (1974).

McGowan. It is believed that to compare the DSL characteristics of the California Current region, whose faunal composition is not endemic, to other regions may further aid our understanding of the DSL phenomenon.

The purpose of this study has been to investigate the characteristics of the DSL, not only as a localized parameter, but more importantly as a wide ranged oceanic phenomenon.

## Materials and Methods

For the last 3 years I have been studying a massive collection of acoustical records, accumulated at Scripps Institution of Oceanography. Data collected on a number of cruises have been used in this study (Table 1). The DSL depths were obtained at a number of segments of cruise tracks (Figure 2).

On fourteen of the cruises the dominant frequency used to obtain DSL records was 12 kHz, and the data were collected using a Precision Depth Recorder (PDR). Records for the remaining cruises were taken using a Simrad Recorder at a dominant frequency of 18 kHz. No significant differences were observed between the two frequencies in ascertaining DSL depth.

The resolution of the acoustic scattering in the ocean will depend on DSL depth and transmitting

TABLE 1  
Cruises from which Deep Scattering Layer  
Data were Obtained

Cruise	Time period
1. Downwind.....	22 Oct 57-28 Feb 58
2. Dolphin.....	27 Mar 58- 9 May 58
3. Scott.....	25 Apr 58-19 May 58
4. Costa Rica Dome.....	6 Nov 59-14 Dec 59
5. Mendocino.....	18 Apr 60-18 May 60
6. Step-I.....	15 Sep 60-14 Dec 60
7. Monsoon.....	28 Aug 60-18 Apr 61
8. Japonyon.....	27 May 61-15 Sep 61
9. Swan Song.....	14 Aug 61- 1 Dec 61
10. Risepac.....	27 Oct 61- 5 Feb 62
11. Papagayo.....	17 Jun 65-12 Aug 65
12. Amphitrite.....	3 Dec 63-29 Feb 64
13. Zetes-Brocas.....	4 Jan 66- 8 Aug 66
14. Albacore Oceanography Cruise 40.....	18 Aug 69-19 Sep 69
15. CalCOFI 6910-J (North) Cruise 41.....	7 Oct 69-30 Oct 69
16. CalCOFI 6912-J (South) Cruise 43.....	28 Nov 69-19 Dec 69
17. SCOR Discoverer Expedition.....	13 May 70-21 May 70
18. Albacore Oceanography Cruise 56.....	5 Oct 70-22 Oct 70
19. Skipjack Resource Assessment No. 1, Cruise 57.....	2 Nov 70-17 Dec 70
20. Skipjack Resource Assessment No. 2, Cruise 60.....	1 Mar 71-16 Apr 71
21. North Pacific Study-10.....	22 Mar 71-29 Apr 71
22. CalCOFI 7202-G.....	8 Feb 72-29 Feb 72
23. CalCOFI 7203-G.....	6 Mar 72-22 Mar 72
24. CalCOFI 7205-G.....	10 Apr 72-15 Jun 72
25. CalCOFI 7207-G.....	11 Jul 72-31 Jul 72
26. CalCOFI 7210-J.....	22 Sep 72-17 Nov 72

frequency. Barraclough, Le Brasseur, and Kennedy (1969), using a high-frequency echo sounder operating at 200 kHz, detected a shallow DSL around 60 m on a transpacific crossing. Johnson (1973), using an acoustic instrumental package with seven frequencies ranging from 3 to 30 kHz, reported the existence of a very deep DSL around 1,700 m off the California coast. A large majority of acoustic information about DSLs, however, has been obtained by depth recorders operating at frequencies ranging from 10 to 30 kHz, and evidence gathered by investigations using these frequencies strongly suggests that there are *principal* layers in the upper 500 m of the Pacific Ocean which can be detected by low frequency echo sounders (Dietz, 1948).

#### DEFINITIONS

Even though literature dealing with the deep scattering layer is massive, to the best of our knowledge, no uniform set of definitions has been established and adhered to by all the investigators in labeling as well as ascertaining layer depths. The following definitions based on the works of other researchers, and new definitions proposed by me, are used throughout this paper.

*Deep Scattering Layer (DSL)*: a group of organisms which scatter sound and appear as a continuous layer on an echo sounder where organisms cannot be individually resolved.

*DSL noontime depth*: the distance between the top of the DSL to the ocean surface taken within a few minutes of local apparent noon. If data around local apparent noon were not available, a reading

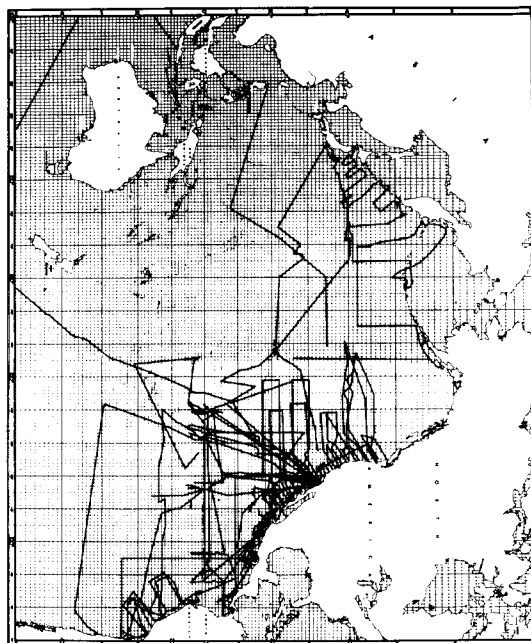

FIGURE 2. Locations of cruise tracks where the DSL depths have been obtained.

between 1000 and 1400 hours local time has been substituted. Only the layers which occupy a midday depth greater than 40 m are considered in this study. Forty meters is roughly the distance below the surface where the outgoing signal is often confused with the incoming signal. Thus, a true depth of a DSL cannot be ascertained with accuracy at this distance interval from the surface.

*Migratory layer*: a layer that migrates at least above the depth of uncertainty (above 40m).

*Semi-migratory layer*: the layer which migrates upward toward the surface, but the upper limit of migration is clearly below the surface.

*Static layer*: a layer which shows no appreciable migratory characteristics.

It should be emphasized that more than one-third of the echograms analyzed for this study have been obtained as a by-product from sea floor mapping cruises where the primary objective of the echo sounder operator has been to minimize the echo scattering from the DSL for a clear recording of the bottom.

#### RESULTS AND DISCUSSION

##### *General Characteristics*

The results of this survey indicate that deep scattering layers are found in every major biotic region of the Pacific Ocean. Single layers are found more frequently than multiple layers; 80% of all the echograms showed a single layer, the remaining 20% showed multiple layers.

Repeated soundings at specific locations further show that the number of layers changes year to year

and single layers are more predominant than multiple layers. Barham (1957) found that in Monterey Bay the number of layers changes throughout the year.

When multiple layers occur (two is the most frequent) almost invariably their individual thickness is less than the single layer monitored at a different time. Thus it is highly conceivable that perhaps due to an external stimulus, such as a change in light intensity, the single layer may split into two components. Since a variety of organisms comprise the DSL, it is probable that only certain species respond to changes in light intensity or other stimulus. There is some evidence to support this view. First, the splitting of a single layer into two or more components during upward or downward migration is a frequently observed phenomenon. Second, Tont and Wick (1973), who monitored the DSL during a solar eclipse in the North Atlantic, found only a partial response of the DSL to the change in light intensity.

It has been further found that static layers, though not found as often as the migratory layers, do not necessarily remain static throughout the year. Evidence of this phenomenon also was found by Beklemishev (1967) in the North Pacific.

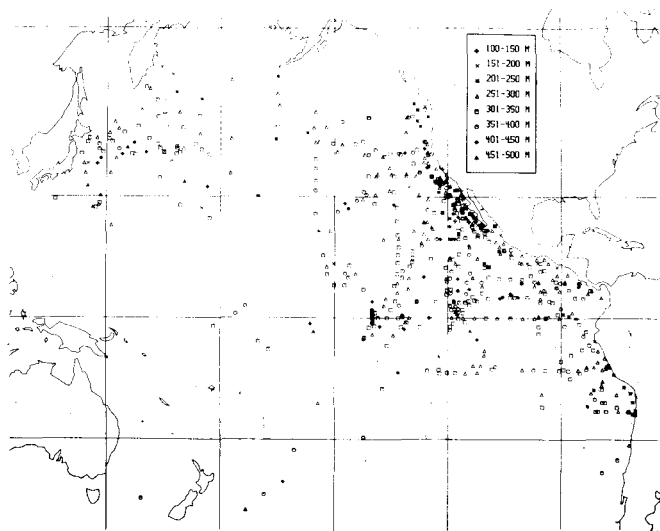

FIGURE 3. The average DSL daytime depth in the oceanic Pacific.

The average DSL daytime depths ranged between 100 and 500 m (Figure 3). The majority of the points represent a single day's sounding. When multiple soundings were available at some locations, an average value of the DSL depths has been used. Extensive data make it possible to show contours of the average DSL daytime depths in the California Current region (Figure 4).

Distributions of average DSL daytime depth in the major biotic regions, as well as several parameters pertaining to these layers, were determined (Table 2). Two very important points should be strongly

emphasized. First, the parameters pertaining to the average DSL daytime depth do not necessarily reflect the typical structure of the regions, but show instead only measurements and calculated irradiance values based on these measurements at the time of monitoring of the layers. Second, the parameters reported pertain to the top of the layer and do not represent the environment of the entire community of DSL organisms. Thus, not all the organisms belonging to a layer as thick as 150 m occupy a certain isolume during the day. Generally layers are shallower in the northern regions such as the Subarctic and in the regions of the California and Peru Currents where the neretic influence is strong. As indicated by the large standard deviations, the layer depth varies significantly with time.

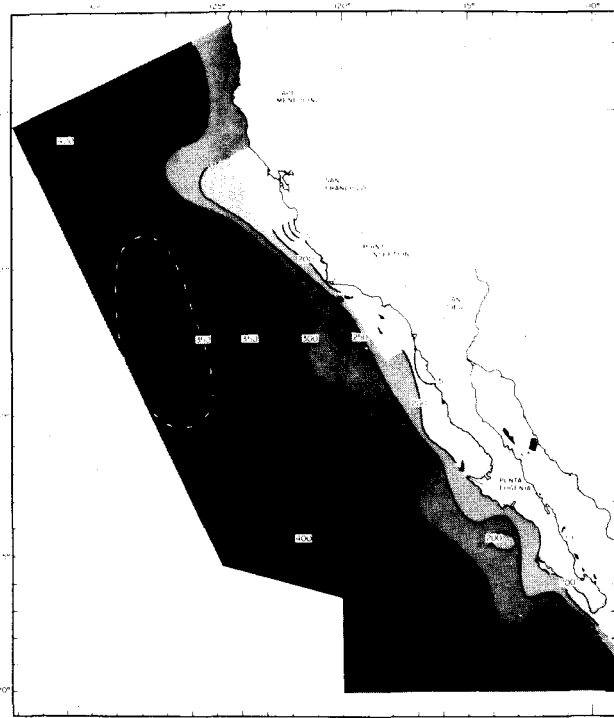

FIGURE 4. Average DSL daytime depths in the California Current System.

Virtually no quantitative information can be obtained about the number and distribution of the organisms from echograms; nevertheless, some qualitative statements could be made. Namely, layers off the coast of Peru were the thickest with clear sharp boundaries. California, Eastern Tropical, North and South Transition Zones as well as areas near the Kuroshio Current also were well formed, but were not as thick as the ones found off the Peruvian Coast.

Although two major crossings have been made in the South Central Region, only twice have scattering layers been observed, but due to the highly diffuse echo that was recorded, these two daytime depths should not be considered reliable. Nevertheless, in both cases the upward movement at sunset and



TABLE 2  
Average DSL Daytime Depths and Related Parameters in the Major Biotic Regions of the Pacific Ocean

Regions	Average DSL daytime depth (m)	N (Number of days)	$\sigma$ (Standard deviation)	Temperature at DSL depth	N	$\sigma$	O <sub>2</sub> at DSL depth (ml/l)	N	$\sigma$
1. Subarctic.....	295	54	--	4.0	28	1.6	7.4	15	1.6
2. Transition (North).....	358	31	51	7.0	3	1.1	--	--	--
3. Central (North).....	394	14	62	--	--	--	--	--	--
4. Eastern Tropical.....	319	130	63	10.9	36	1.0	0.2	36	0.2
5. Equatorial.....	350	76	53	10.4	27	1.1	0.6	25	0.2
6. Central (South).....	410	2	--	--	--	--	--	--	--
7. Transition (South).....	333	4	60	--	--	--	--	--	--
8. Subantarctic.....	415	3	48	--	--	--	--	--	--
9. California Current.....	282	110	69	9.9	6	1.8	0.6	6	0.7

downward movement at sunrise, when the layers were close to the surface, were clearly discernable.

**Temperature**

Moore (1958) proposed that temperature was the controlling factor for the vertically migrating organisms. Cole, Bryan, and Gordon (1970) report the absence of any scattering layer along the 50 mile transition from the Sargasso Sea to the slope waters on four crossings and attributes this absence to the Gulf Stream which marks a severe hydrological boundary.

There is a wide range of temperatures at DSL depths (Table 2). The relatively low standard deviations of temperature within each region should not be construed as an optimal temperature preferred by DSL organisms, since a change of 1°C may correspond to a depth change of 100 m in the ocean. It is not uncommon to find temperature changes as much as 5.5°C at the DSL depths from one location to another during a single transect (Figure 5). Again, if the temperature at the DSL daytime depth is the preferred optimum temperature, then one would assume that the downward migration would stop when these temperatures are first reached. No evidence to support this assumption was found (Figure 6a, b, c).

On the other hand, a sharp temperature gradient may limit the upward migration of DSLs in the subarctic region (Figure 6). DSL nighttime depth can be just below the thermocline (Figure 6a, b). In cases where no sharp thermocline exists, the DSL organisms migrate all the way to the surface (Figure 6, profile C). Unfortunately we do not have enough data to ascertain whether partial migration is temperature dependent in other regions as well.

**Oxygen (O<sub>2</sub>)**

Bary (1966) found a dependency of DSL on an oxycline in Saanich Inlet. We have found no evidence of oxygen influencing DSL depth. In regions where the oxygen minimum is most pronounced, DSL organisms in no way seem to be restricted by low O<sub>2</sub> concentrations (Figure 7). Similar results have been obtained by Dunlop (1970) in the same region. Teal and Carey (1967) and Childress (1969) found that some DSL organisms, such as euphausiids, can survive in extremely low O<sub>2</sub> concentrations.

**Light**

The upward and downward migration of some DSLs during sunset and sunrise strongly suggest

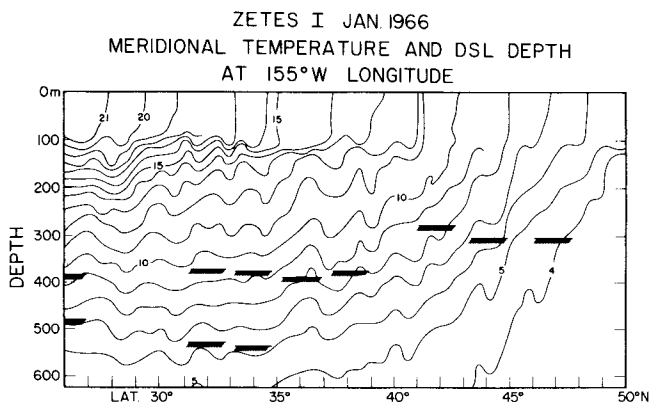

FIGURE 5. Meridional temperature and DSL depth at 155° W longitude. ZETES I Expedition January 1966.

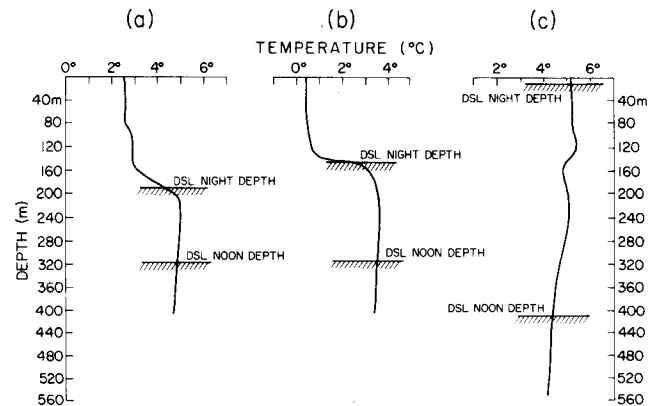

FIGURE 6. Temperature profiles and DSL daytime and nighttime depths in the Subarctic Region. (a) 49° 18' N, 163° 12' E; 8 March 1956. (b) 51° 09' N, 161° 16' E; 9 March 1966. (c) 41° 46' N, 156° 47' E; 19 March 1966.

VERTICAL DISTRIBUTION OF OXYGEN ( ml/L )  
AND DSL DEPTH ALONG 85° W

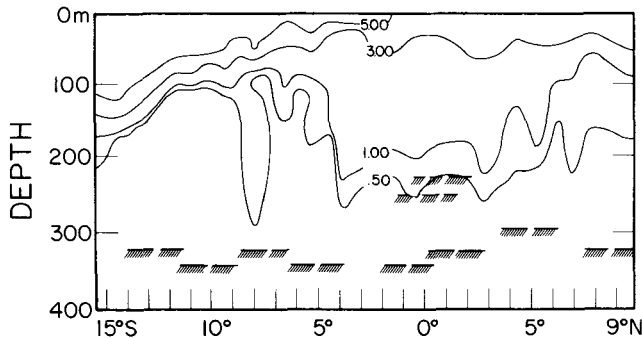

FIGURE 7. Vertical distribution of oxygen (ml/l) and DSL depth along 85° W.

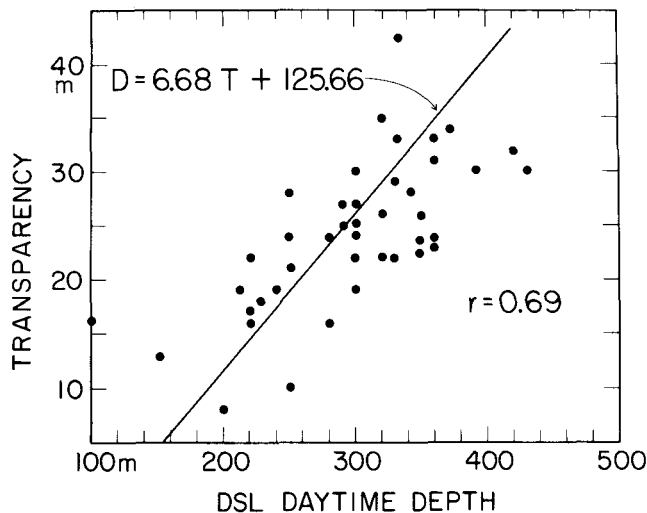

FIGURE 8. Transparency versus DSL daytime depth in the California Current region, where  $r$  is the correlation coefficient and  $p$  is the probability.

light-related behavior. Kampa (1970), investigating four layers in the eastern North Atlantic and two in the Gulf of California, reported remarkable similarities in the photo environment of the layers. Isaacs, Tont, and Wick (1974) found a strong correlation between light levels and DSL daytime depth in the Peruvian Current region.

The relationship between transparency and DSL depth in the California Current and Eastropac regions (Figure 8) is very similar to the curve obtained by Isaacs et al. (1974) in the Peru Current region.

The following considerations strongly suggest a light oriented behavior on the part of the DSLs:

1. Light penetration would be less in regions of high productivity than in other regions, due to absorption by chlorophyll and phaeopigments. According to Koblents-Mishke (1967), who conducted an extensive study of the primary productivity of the Pacific Ocean, the maximum

phytoplankton concentrations are found in a narrow zone off the coast of North and South America from 60° N to 25° S, and in the Subarctic Region. Thus, it is not surprising that most of the shallow DSLs are found in these regions (Figure 3).

2. The average DSL daytime depth decreases gradually from equatorial to Subarctic regions; so does the incoming solar irradiance. In addition, Frederick (1970) reports considerably lower secchi disk values for the Subarctic than for the Equatorial Region.

## CONCLUSIONS

My study indicates that light is the controlling factor in DSL daytime depth, even though the effect of temperature, which may limit the upward migration, cannot be discounted completely. It is quite possible that, depending on the type of community, organisms may seek an optimal depth regulated by light intensity, but within a specific temperature range.

## ACKNOWLEDGMENTS

I thank the following individuals for their help with this study: John D. Isaacs, Richard Schwartzlose, Eric Barham, Paul Smith, Thomas Chase, Gerald Wick, Stephen Tucker, John McGowan, Walter Bryan, Norio Shiora, Anthony Tubbs, Norman Anderson, Donna DeCamp, Meredith Sessions, Frances Wilkes, and Vickie Gellespie.

## REFERENCES

- Barham, E. G. 1957. The ecology of sonic scattering layers in the Monterey Bay area. Stanford Univ., Hopkins Mar. Sta. Tech. Rept., (1): 1-182.
- Barraclough, W. E., R. J. LeBrasseur and O. D. Kennedy. 1969. Shallow scattering layer in the Subarctic Pacific Ocean: detection by high-frequency echo sounder. *Science*, 166(3905): 611-612.
- Bary, D. McK. 1966. Quantitative observations of scattering of 12 kc/s sound in Saanich Inlet, British Columbia. *Deep-Sea Res.*, 13: 667-677.
- Beklemishev, K. V. 1967. Echo-sounding records of macroplankton concentrations and their distribution in the Pacific Ocean. N.O.O. Trans. 343, Naval Oceanogr. Office, Washington, DC. 49 p.
- Childress, J. J. 1969. The respiration of deep-sea crustaceans as related to their depth of occurrence and the oxygen minimum layer. *Abstract 222, Am. Zool.*, 9(4): 1100.
- Cole, H. P., G. M. Bryan and A. L. Gordon. 1970. The deep scattering layer: patterns across the Gulf Stream and the Sargasso Sea. 281-293 p. *In Proc. of an international symposium on biological sound scattering in the ocean.* (G. B. Farquar, ed.) NC Report 005, Dept. of the Navy, Washington DC.
- Dietz, R. S. 1948. Deep scattering layer in the Pacific and Antarctic Oceans. *J. Mar. Res.*, 7(3): 430-442.
- Dunlap, C. R. 1970. A reconnaissance of the deep scattering layers in the eastern tropical Pacific and Gulf of California. 395-408 p. *In Proc. international symposium on biological sound scattering in the ocean.* MC Report 005, Dept. of the Navy, Washington, DC.

- Frederick, M. A. 1970. An atlas of secchi disc transparency measurements and ford-ule color codes for the oceans of the world. Master thesis. U.S. Naval Post-graduate School, 188 p.
- Isaacs, J. D., S. A. Tont and G. L. Wick. 1974. Deep scattering layers: vertical migration as a tactic for finding food. *Deep-sea Res.*, 21: 651-656.
- Johnson, R. K. 1973. Very deep scattering layer. *J. Acoust. Soc. of Am.*, 54: 805-806.
- Kampa, E. M. 1970. Photoenvironment and sonic scattering. 51-59 p. *In* Proc. and international symposium of biological sound scattering in the ocean. MC Rept. 005, Dept. of the Navy, Washington, DC.
- Koblents-Mishke, O. I. 1967. Primary Production 83-99 p. *In* (V. G. Boqorov, ed.) *Biology of the Pacific Ocean*. English Trans. No. 435. U.S.N.O.O., Washington, DC. 1964.
- McGowan, J. A. 1974. The nature of oceanic ecosystems. 9-28 p. *In* (C. B. Miller, ed.) *The biology of the oceanic Pacific*, Oregon State Univ. Press, Corvallis, OR.
- Moore, H. B. 1958. *Marine Ecology*. John Wiley and Sons, Inc., New York, 493 p.
- Teal, J. M. and F. G. Carey. 1967. Respiration of a euphausiid from the oxygen minimum layer. *Limnol. Oceanogr.*, 12(3): 548-550.
- Tont, S. A. and G. L. Wick. 1973. Response of the deep scattering layer to the 1972 total solar eclipse. *Deep-Sea Res.*, 20: 769-771.

# BENTHIC OCEANOGRAPHY AND THE DISTRIBUTION OF BOTTOM FISH OFF LOS ANGELES\*

ALAN J. MEARNS AND LUCINDA SMITH

Southern California Coastal  
Water Research Project  
El Segundo, California 90245

## ABSTRACT

Changes in bottom water isotherms of the coastal shelf appear to have a direct effect on the abundance and diversity of demersal fishes and invertebrates. These changes are also highly correlated with near-bottom dissolved oxygen concentrations. In addition, resident fauna of the shelf can experience warmer water in winter than in summer. These effects are probably caused by incursion of offshore basin waters onto the coastal shelf following development of the thermocline. Recognition of these events may aid in clarifying and defining (a) shelf community structure, (b) our concept of the terms "near-shore" and "off-shore", and (c) monitoring and survey programs adequate for separating natural from man-induced effects.

## INTRODUCTION

The nearshore coastal zone off southern California is a productive yet distinct and diverse environment between the land and the open sea. Because of a wide variety of commercial, recreational, and scientific interests, we know a great deal about the intertidal and shallow subtidal environments (to about 40 m) but very little about the vast remainder of the continental shelf (which is from 40 to 200 m deep), the slope, or the basins (3 to 15 km offshore). Yet these large areas now receive the bulk of domestic wastes discharged into the coastal waters off southern California.

Our familiarity with the organisms that inhabit the area between the intertidal zone and the eastern edge of the California Current is increasing as a result of numerous trawl and benthic surveys. We know, for example, that the populations of the coastal self are diverse, that their distribution is uneven—often related to depth—and that they are affected by waste discharge (Southern California Coastal Water Research Project, 1973). Benthic fish and invertebrate populations are colorful and active. There appear to be large populations of shrimp, flatfish, and rockfish at middepths on the coastal shelf; hake, grenadiers, and sablefish live along the edge of the continental shelf, and a variety of midwater fishes occupy the waters overlying the basins.

We do not yet have an understanding of the physical, chemical, and biological factors that control the distribution and abundance of offshore coastal

fish and invertebrate populations. These populations may be affected by the composition of the benthic sediments and the availability of food organisms as well as by the temperature and dissolved oxygen content of the waters, both of which decrease with depth. In fact, temperature has often been used elsewhere as a predictive tool in coastal fisheries (Laevastu and Hela, 1970). Unfortunately, there have been few local coastal surveys in which fish, sediments, and bottom water quality were studied simultaneously. For example, oxygen and temperature in coastal waters are monitored frequently, but not often in conjunction with trawl surveys and rarely near the bottom at depths beyond 50 m. Contamination of marine sediments by metals and hydrocarbons also is monitored intensively, but only in cases of severe contamination can these measurements be related to anomalous fish distributions (Southern California Coastal Water Research Project, 1973). Thus, the data from many monitoring programs are inadequate to describe the major environmental factors regulating the distribution of coastal marine fish and macroinvertebrate populations.

## METHODS

During the past year, several kinds of programs were initiated by the Coastal Water Research Project and other agencies to better describe the physical characteristics of the coastal benthic environment. Whenever possible, we have taken hydrographic samples at the surface, at middepth, and 1 to 2 m from the bottom at each trawl station during quarterly or biannual surveys off Dana Point and Palos Verdes, and in San Pedro and Santa Monica Bays. To provide additional depth and regional perspectives, the Project conducted a 3 day synoptic survey in September 1973 (Mearns and Greene, 1974). In this survey, water samples were analyzed for temperature and dissolved oxygen content and, in some cases, pH and salinity. This information supplemented the basic catch statistics we obtained from standardized trawl hauls (2 to 2.5 knots, 10 minutes on the bottom, using otter trawls with 25 ft headropes).

The Project also conducted two special cruises in January and June 1974 to examine temperature, dissolved oxygen, salinity, pH, and coliform gradients in a portion of the Santa Monica Basin (to depths of 900 m) adjacent to the coastal shelf. These data were

\* Contribution 31 of the Coastal Water Research Project.

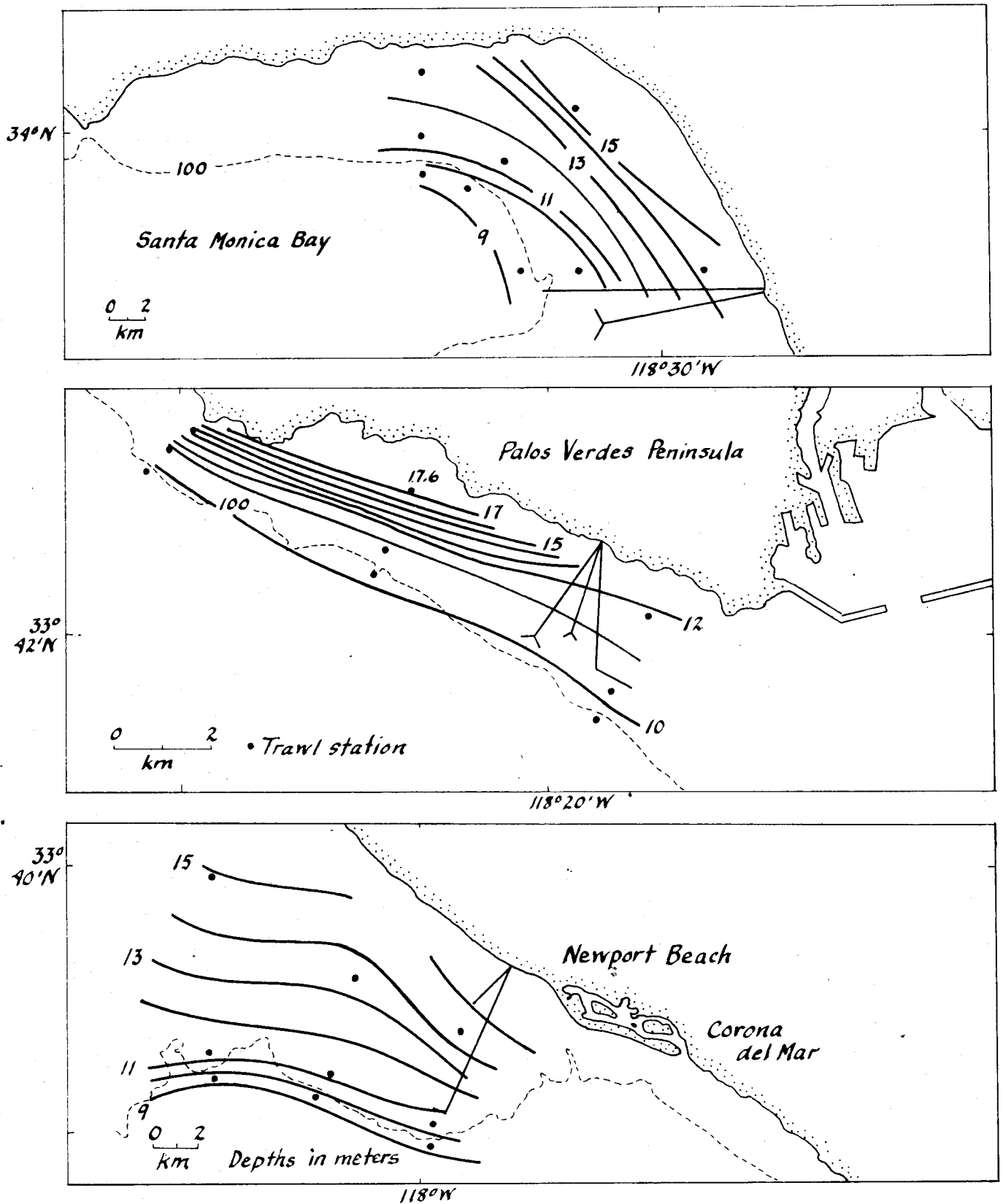

FIGURE 1. Bottom water isotherms ( $^{\circ}C$ ) in three coastal shelf areas of southern California, 24-26 September 1973 (From Mearns and Greene, 1974). Major municipal wastewater outfalls are shown.

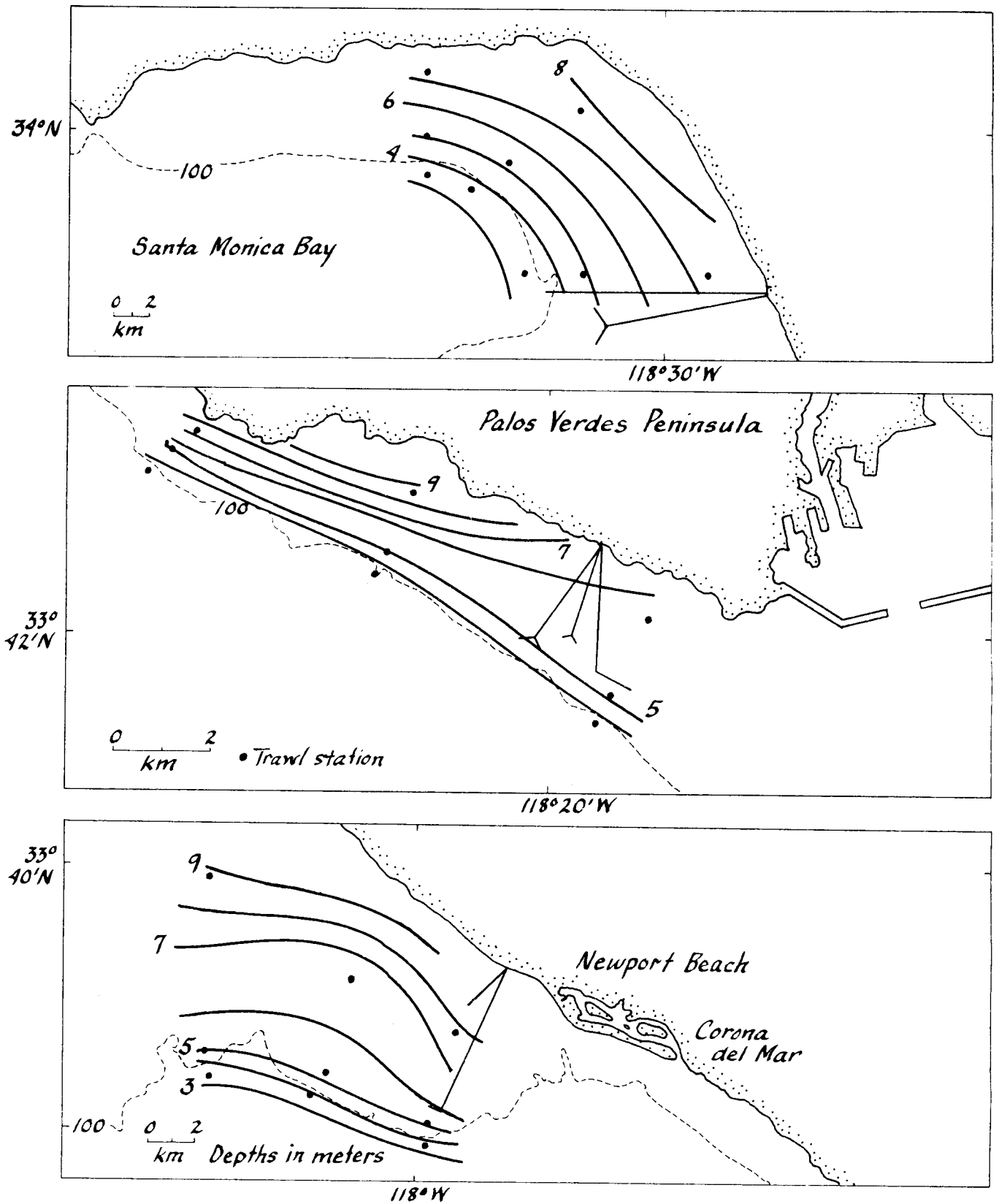

FIGURE 2. Bottom water dissolved oxygen isopleths (mg/l) in three coastal shelf areas of southern California, 24 to 26 September 1973 (From Mearns and Greene, 1974).

compared to those taken inshore at similar depths to observe the possible effects of offshore subsurface water activity on the coastal shelf waters at similar depths (Mearns and Smith, 1975). We have also examined oceanographic data from ongoing monitoring surveys to verify what appeared to be major changes in surface, midwater, and bottom-water isotherms and dissolved oxygen isopleths.

The data from these surveys were then compared to information on demersal fish and other benthic organisms. We plotted bottom water temperature and dissolved oxygen by depth and season. These data were compared to similar summaries of catch statistics (median catch and biomass, diversity and number of species per unit effort) and other survey attributes such as species and site clusters as

described in the project's 3 year report (1973) and more recently by Allen and by Greene and Sarason (Southern California Coastal Water Research Project, 1974). The analyses were designed to reveal general patterns rather than specific details.

**RESULTS**

Bottom water contours of temperature and oxygen in Santa Monica Bay, off Palos Verdes, and in San Pedro Bay during September 1973 (Figures 1 and 2) were determined when all three regions were surveyed by identical physical and biological survey methods (Mearns and Greene, 1974). Striking gradients of decreasing values were observed as we proceeded offshore in all three areas. Inshore (26 m), demersal and benthic biota were exposed to temperatures ranging from 15° to 18°C and oxygen values ranging from 6 to 9 mg/l. Offshore (170 m), the benthos was exposed to temperatures ranging from 9° to 11°C and oxygen concentrations ranging from 3.5 to 5.5 mg/l. In each area, the ocean outfalls were discharging into relatively cool (10° to 11°C), low oxygen (4 to 6 mg/l) water, and anomalously low oxygen distributions were related to temperature more than to proximity to the discharges. The variability of temperature and oxygen within a given depth interval was surprisingly low (Figure 3).

The trawl catch data taken in conjunction with these measurements showed rather striking relationships with depth, temperature, and dissolved oxygen (Figure 3). From 27 to 62 m, fish biomass, abundance, number of species, average size of fish, and diversity increased with depth and with decreasing temperature and dissolved oxygen. Beyond 62 m, we found no major increases in biomass, number of species, abundance, or diversity, but the average size of fish increased; temperature and oxygen decreased at much lower rates in this area than inshore. No samples were taken beyond 150 m.

The data we have at present are sporadic, and thus our interpretation is equally limited. For example, visual avoidance of gear by fishes may be a factor contributing to the low catches inshore in the daytime, and on-bottom sampling time in deep waters may be longer than that in shallow water because of the increased scope ratios (John Stephens, Occidental College, Los Angeles, pers. comm.). However, the general trends in the biological curves (i.e., the maximum values at midshelf depths) do correspond to other biological features such as maximum benthic biomass, or potential food (Southern California Coastal Water Research Project, 1973). Similar relationships have been observed in other surveys in which different gear were used. In Santa Monica Bay during the spring of 1972, peak values occurred at somewhat shallower depths—25 and 50 m (Mearns, Allen, and Sherwood, 1974); in the winter and summer of 1960, peak values

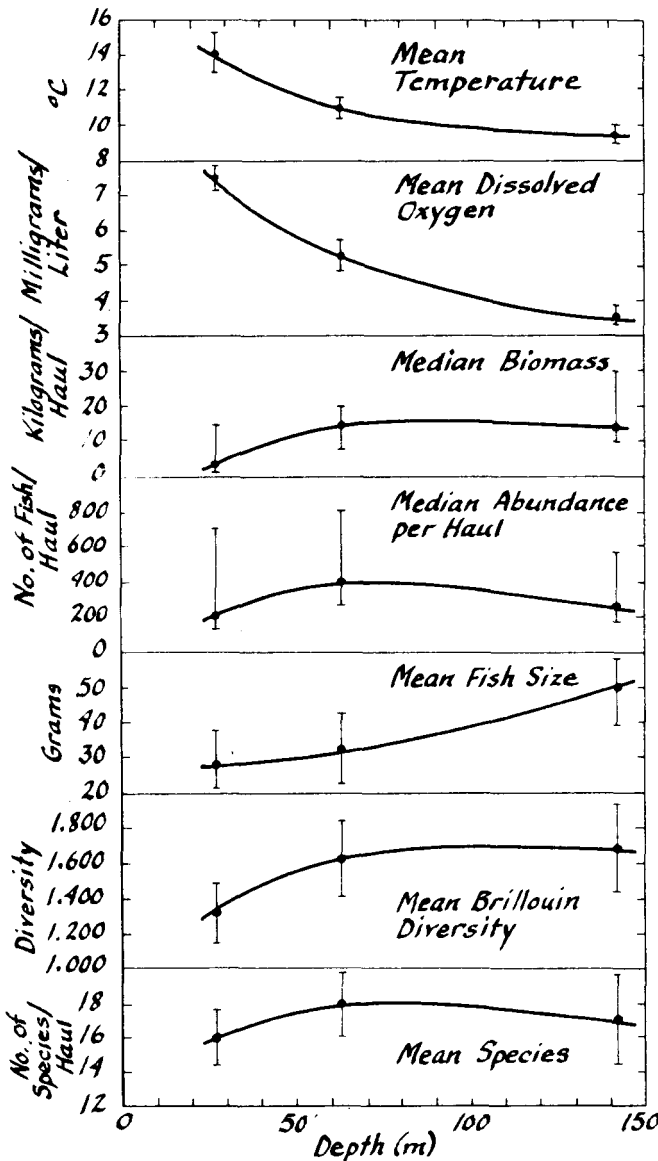

FIGURE 3. Mean ( $\pm 2$  SE<sub>x</sub>) or median ( $\pm 95$  percent confidence limits) values for seven variables measured in three coastal shelf areas of southern California, 24 to 26 September 1973.

occurred at different depths between 37 and 140 m (Southern California Coastal Water Research Project, 1973). Overall, the data suggest that benthic fish are responding, to some extent, to temperature, oxygen, or other depth-related factors such as light and food availability.

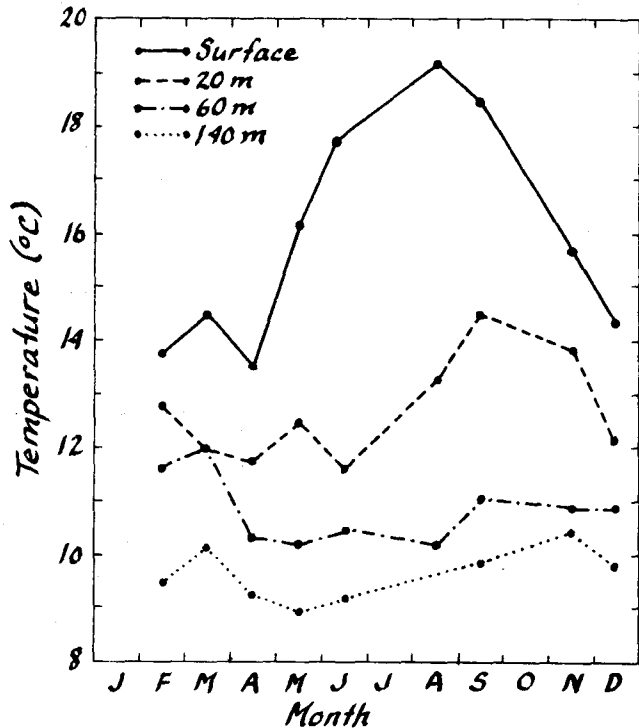

FIGURE 4. The 1972 and 1973 temperatures of surface waters and near-bottom waters at 20, 60, and 140 m on the coastal shelf of Los Angeles and Orange Counties.

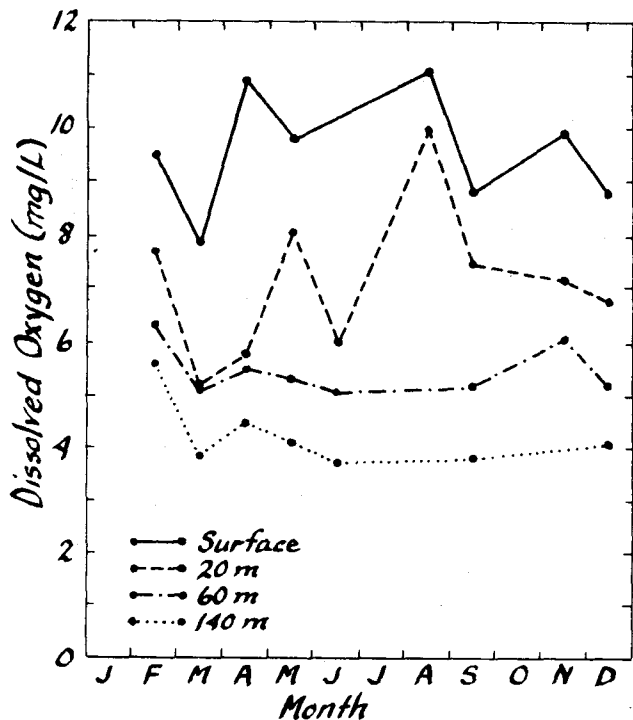

FIGURE 5. Annual change in temperature and dissolved oxygen values of surface and near-bottom waters on the coastal shelf of Los Angeles and Orange Counties, 1972-73.

Although much biological and environmental data remains to be analyzed and correlated, we have summarized information on seasonal changes in benthic water characteristics for various depths on the coastal shelf to observe for divergent benthic exposure patterns. A compilation of annual surface and bottom water changes in temperature and dissolved oxygen at several depths is of interest. While surface temperatures (Figure 4) display a typical pattern of warming in the spring and summer and cooling in the fall and early winter, deeper waters do not. In fact, below a depth of 25 to 60 m, the benthic waters are cooler in summer than in winter. Both the absolute temperatures and the temperature range at each depth generally decrease with depth. Annual temperature ranges ( $\Delta T$ ) rapidly decrease between the surface and about 25 m and then decrease more slowly below this depth (Figure 5).

Dissolved oxygen concentrations show similar patterns beyond the 20 m isobath (Figures 5 and 6). In fact, changes in bottom water dissolved oxygen are directly correlated with temperature changes (Figure 7), particularly in waters below 25 m.

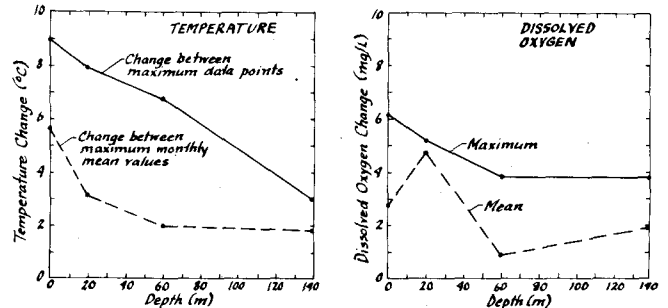

FIGURE 6. The 1972 and 1973 dissolved oxygen content of surface waters and near-bottom waters at 20, 60, and 140 m on the coastal shelf of Los Angeles and Orange Counties.

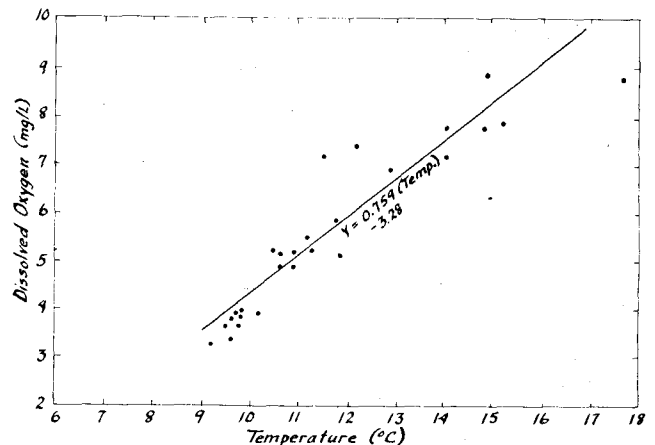

FIGURE 7. Bottom water temperature vs. dissolved oxygen in three coastal shelf areas of southern California, 24 to 26 September 1973. Linear correlation,  $r = 0.934$  ( $p < 0.001$ ).



**Relationships Between Coastal Shelf and Offshore Basin Waters**

Additional data suggest that the characteristics of the water masses near the bottom of the coastal shelf change gradually, with little perturbation, as one moves from the shore over the shelf and into the cold, low oxygen water of the adjacent basins. Profiles of temperature and oxygen at stations in Santa Monica Bay sampled during January and June

1974 indicate that below 300 m, there seems to be little change in temperature or oxygen from summer to winter (Figure 8). But during the same time period, the waters between 20 and 200 m appear to undergo cooling and decrease in oxygen content (similar trends, which suggest upwelling, have been noted offshore; Dr. Paul Smith, National Marine Fisheries Service, La Jolla, pers. comm.). In the 1974 survey, we observed that a seasonal thermocline, with warm, well oxygenated water, had formed above 20 m, thus inhibiting vertical movement or mixing of the waters.

**Implications of the Characteristics of the Subsurface Waters of the Coastal Shelf**

A recognition of the major environmental gradients in temperature and other basic characteristics of the bottom waters of the coastal shelf may simplify our understanding of the constituents of the nearshore biota and the interplay of the faunal units characteristic of local coastal areas. The seasonal thermocline has long been recognized as a feature allowing the development of the fauna most characteristic of southern California. But even at its maximum development of 20 to 50 m, the thermocline intersects only a portion—30 to 50%—of the coastal shelf occupied by marine populations and used by man. The waters below this layer may have quite different physical attributes than those in the inshore zone or above the slope and basins. Likewise, the depths at which isotherms fluctuate the most (e.g., inshore, at 10 to 40 m) may have biological attributes of their own. There may be a number of zones on the coastal shelf (e.g., between 10 and 150 m) that are defined by temperature alone, and anomalies in the depths of these zones can be expected near submarine canyons or other unique topographic features. A typical pattern of isotherms forms during or following the development of the thermocline in summer (Figure 9). Of particular importance is that, although much of the coastal shelf (Area C on Figure 9) may be unaffected by the seasonal thermocline (but greatly influenced by the

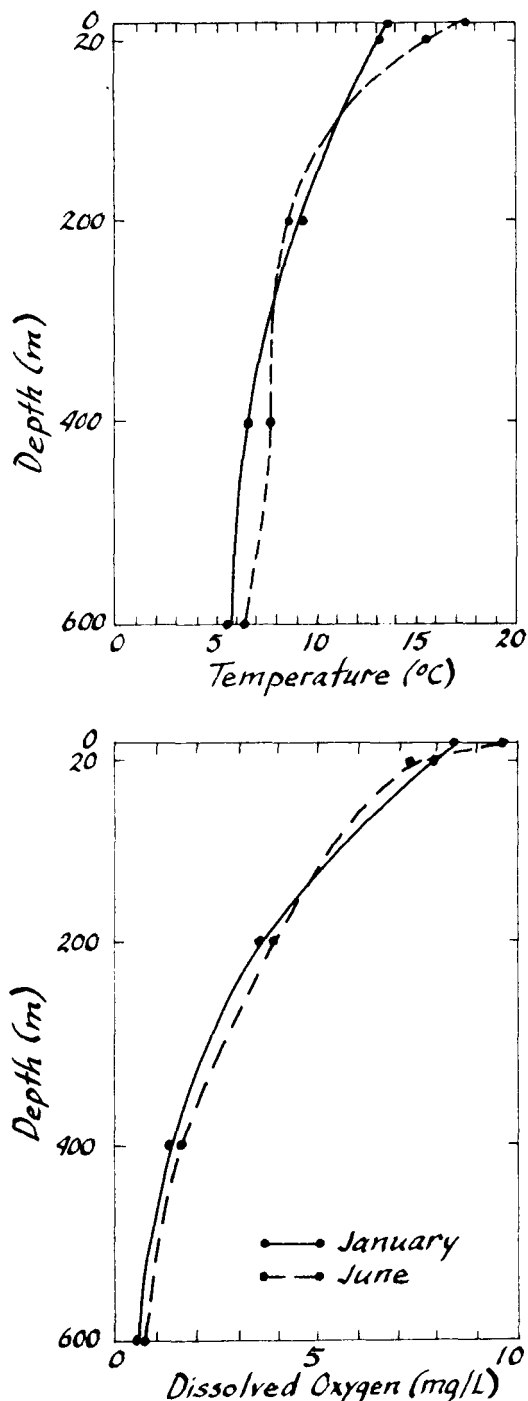

FIGURE 8. Temperature and dissolved oxygen in the northeastern portion of Santa Monica Basin, January and June 1974.

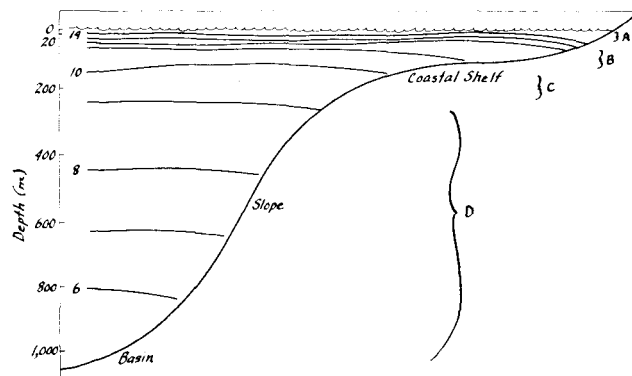

FIGURE 9. Section of the coastal shelf of southern California showing four possible environmental zones defined by temperature ( $^{\circ}\text{C}$ ).

basin waters), there may be an area inshore (Area B) that is subject to rather rapid temperature increases and decreases, depending on currents and on the rate of development of the thermocline and its strength. Offshore of the shelf edge (Area D), temperature and oxygen fluctuations are minor.

These patterns are somewhat consistent with the general faunal changes and faunal zonation on the coastal shelf, such as the recurrent group associations of benthic fishes described by the Project (1973). In addition, demersal and benthic fauna inshore of 20 m generally show major seasonal changes in abundance and species composition associated with temperatures. Our analyses, which are still in progress, suggest that there is an abrupt compositional change between 20 and 60 m, particularly in the demersal fish and shrimp fauna. From 60 to 20 m, there are additional but more gradual faunal changes in populations of shrimp, flatfishes, poachers, and rockfishes.

Bottom water dynamics may explain changes in the distribution of many coastal fishes, such as the inshore congregations of bottom fishes observed in Santa Monica Bay between January and June 1960 (Southern California Coastal Water Research Project, 1973; based on a reanalysis of data reported by Carlisle, 1969). An incursion of offshore bottom water (e.g., water from 60 to 200 m) into an inshore (5 to 20 m) trawl survey area could substantially change the nature of the demersal and benthic fauna and its abundance at one or more sites. Likewise, such events can successfully deliver larvae of demersal and benthic animals to different localities, depending on the bottom topography, the weakness of the thermocline, or the movements of bottom water stimulated by entrainment at large outfall sites.

Finally, year-to-year differences in the dynamics of nearshore and surface waters and those of bottom waters may partially account for longer term, apparently unrelated changes in nearshore and demersal fish populations. For example, Carlisle (1969) showed data on average annual surface and bottom water temperatures and on sport and trawl monitoring catch statistics in Santa Monica Bay. Reexamination of these plots suggests an inverse relation between surface and bottom water temperatures and between sport catches (primarily

predatory fishes from the water column) and trawl catches (primarily benthic and small forage fishes).

Continued simultaneous monitoring of benthic and demersal biota and the variables of bottom (or even near-bottom) waters such as temperature and dissolved oxygen should help refine our understanding of the coastal shelf and aid in distinguishing natural biological anomalies from those induced by man's use of the shelf. Adjustments of ongoing coastal monitoring programs and coordination with programs of larger scope, such as CalCOFI, should greatly enhance this effort.

#### ACKNOWLEDGMENTS

We appreciate the assistance and cooperation of the biologists, technicians, and ship crews of the sanitation districts of Los Angeles County, Orange County, and the City of Los Angeles. We also thank John Stephens, his students, and the staff of the Vantuna Consortium. Charles Greene and James Allen of the Coastal Water Research Project greatly assisted in the field and in data compilation.

This work was supported by the U.S. Environmental Protection Agency under Grant R-801152.

#### REFERENCES

- Carlisle, J. G., Jr. 1969. Results of a six-year trawl study in an area of heavy waste discharge: Santa Monica Bay, California. *Calif. Fish and Game*, 55(1): 26-46.
- Laevastu, T., and I. Hela. 1970. Fisheries oceanography, new ocean environmental services. Fishing News, Ltd. (London). 238 p.
- Mearns, A. J., and C. S. Greene, eds. 1974. A comparative trawl survey of three areas of heavy waste discharge. Tech. Memo. TM 215, Southern California Coastal Water Research Project, El Segundo, California. 76 p.
- Mearns, A. J., and L. Smith. 1975. A hydrographic survey of Santa Monica Basin, January and June 1974. Tech. Memo. TM 218, Southern California Coastal Water Research Project, El Segundo, California. 25 p.
- Mearns, A. J., M. J. Allen, and M. J. Sherwood. 1974. An otter trawl survey of Santa Monica Bay, May and June 1972. Tech. Memo. TM 209, Southern California Coastal Water Research Project, El Segundo, California. 24 p.
- Southern California Coastal Water Research Project. 1973. The ecology of the Southern California Bight: Implications for water quality management. Tech. Rept. TR 104, El Segundo, California. 531 p.
- . 1974. Annual report for the year ended 30 June 1974. El Segundo, California. 197 p.

**Part III**

**CALCOFI CONFERENCE**

**SANTA BARBARA, CALIFORNIA**

**NOVEMBER 12-14, 1974**



# A COLLECTION OF RAMBLINGS ON TRADITIONAL AND NEW AVENUES OF PHYTOPLANKTON STUDIES AS THEY RELATE TO MARINE FOOD WEBS

RICHARD W. EPPLEY  
Scripps Institution of Oceanography  
La Jolla, California 92037

I suppose that in the beginning when research teams were organized to study plankton ecology a phytoplankton person was employed largely for two purposes. First, to identify the species of phytoplankton that were being collected, and secondly to measure primary production. The latter has always been thought of as perhaps a good thing in itself, and with some notable exceptions primary production has often been measured as a routine part of things. CalCOFI, until recently at least, has been an interesting exception.

Fortunately time passes and those of us who blindly measure primary production without knowing what really to do with the data are beginning to get the drift of some new directions, and I think that emphasis is shifting. This is in part because of the impact of theoretical ecologists telling us more about how natural systems work. In part it has something to do with the training of the people who are called upon to do the measurements, and there are lots of intangibles.

I learned rather late that one really ought to consider not only the production of plant material itself, but also what happens to it. What is the fate of phytoplankton production in the oceans? Those of us brought up in molecular biology traditions learned that one can write an equation for the growth of organisms in culture—a culture of bacteria or culture of unicellular algae, it's all the same. The differential equation says that the rate of change of the population is a function of the initial population times some growth constant. The ecologists would like us to be aware of the fact that there is also a mortality associated with the phytoplankton; and indeed if one is doing field work in an area he knows that phytoplankton crops go up and down or remain steady, but certainly there is no exponential increase year after year as would be predicted simply by the growth equation. Obviously, something happens to the stuff and we ought to think about that more.

The first question I'd like to address is, "What are the causes of phytoplankton mortality?" We know, at least over the long term, that if one subtracts mortality rates from growth rates the value approaches zero.

First of all it has long been known that phytoplankton sink, and in recent times there have been rather sophisticated measurements made of the rate at which phytoplankton sink. A number of generalizations have resulted from that sort of work. If a phytoplankton sinks out of the illuminated upper layer of the ocean it tends to consume itself by dark

respiration, or it may be eaten on the way down. If it reaches the bottom it enters a detrital food chain where it is probably eaten or decomposed by bacterial or fungal activity, in a way entirely analogous to a leaf fall in a forest. Phytoplankton no doubt do contribute to detrital food webs, probably more so in shallow coastal waters than offshore. But to my knowledge we have very little direct information on this point.

Those of you among the audience who are zoologists are aware that phytoplankton are eaten by herbivorous beasts. Much of the phytoplankton that is eaten, and the numbers vary from 20% to 30% or a bit more, is not digested but rather leaves the animal as fecal material. The fecal pellets of copepods sink too, and fecal pellet sinking rates have also been studied. Fecal pellets can either sink out of the water column and enter detrital food webs or it is conceivable, and probably likely, that many of them are eaten again on the way down as John Isaacs pointed out. The point is that not all phytoplankton production is immediately directed into a linear food web where it is grazed on only by herbivores.

Another point worth making is that not all the organisms that we commonly think of as phytoplankton are totally autotrophic. For example, in 1967 the Food Chain Group undertook a study of plankton populations off La Jolla. The study ran on for 7 months. Freda Reid and Jim Jordan laboriously counted all the phytoplankton taken in the weekly samples and discovered that about 5% of the phytoplankton biomass consisted of dinoflagellates that probably do not contain chlorophyll at all. The dynamics of this crop of nonchlorophyll-containing dinoflagellates was such that their numbers varied directly with the rest of the phytoplankton. This suggested to us that possibly they were feeding on phytoplankton directly, or else perhaps they utilized the dissolved organic matter released by the phytoplankton. To this day we don't know which alternative is more nearly correct because we haven't been able to get the organisms into culture in spite of several attempts.

Another role is the one Dick Dugdale brought out in his slide representing the model for nitrogen cycling: that phytoplankton play a rather direct role in nutrient recycling. Phytoplankton that are grazed upon and digested contribute their nutrients to the herbivore. The herbivore releases some of these with the excretory products. In case of nitrogen much of this is ammonia, a little bit is urea, some is organic nitrogen. Recent work has shown that ammonia and

urea can be directly reassimilated by phytoplankton. This recycling no doubt takes place at all stages of food conversion not only with the herbivores but with omnivores, carnivores, etc. Apparently most of the elements that we consider to be fertilizer elements, such as nitrogen, phosphorus, silicate, so forth, go through such cycles.

Dugdale has made a useful distinction between new production and regenerative production, where the regenerated production represents that based on recycled nutrients and new production representing inputs from the outside, whether it be nitrate upwelling from deep water, or nitrogen gas being fixed by blue-green algae in the water column, or what have you. The phytoplankton people have gotten into this aspect in some force recently.

Another role of phytoplankton has turned out to be to amuse modelers. In many civil engineering departments engineers have been called upon to prepare models of receiving waters of various kinds and to predict the behavior of phytoplankton in these waters. They have been relying heavily on Dugdale's nutrient uptake kinetics and on some of the generalizations about phytoplankton growth that have fallen out of other work. This has been very gratifying to the phytoplankton people because they almost began to feel useful for a change.

Geochemists and geologists are aware that phytoplankton contribute to the siliceous and carbonaceous sediments in the world's oceans. It's not clear to me, although it may be to others, whether this represents the sinking of phytoplankton directly from the water column, or whether most of their skeletons arrive via fecal material. But one suspects it's probably the latter. But to look at the role of the phytoplankton from the phytoplankton's "point of view," in the strictly evolutionary biologic sense, the role of the phytoplankton is to make more of themselves, and this they apparently do rather nicely. Almost all of the ecologically significant natural phytoplankton species apparently reproduce by simple cell division, one cell going to two. As Dick Dugdale pointed out, sex has been discovered in diatoms. Bob Holmes, when he was with the Food Chain Group, was aware of this. He saw gametes and auxospores in a variety of diatoms. But as yet we have no real way of identifying the importance of sexual reproductive activity in the maintenance of populations in the sea.

So much for the role of phytoplankton in marine food webs. I think I've said about all that I can say easily, and perhaps I should turn your attention to the role of the phytoplanktologist in understanding pelagic food webs.

I've already indicated that from simple beginnings a captive biologist can measure primary production and describe the species present. Some people have even broken out of that mold relatively early. For example, John Ryther wrote a rather classic paper in

*Science* in 1969, in which he considered the possibilities for fish production in various parts of the ocean. In that paper he assumed a strictly linear food web where one went from phytoplankton to herbivorous animals to carnivorous animals of several stages—there may be several of these—and he used a very simple mathematical expression to calculate the quantity of fish that could be produced. He noted that the production of fish would be equal to the production of phytoplankton times the efficiency of the food chain conversion in each trophic step to the  $n^{\text{th}}$  power where  $n$  represents the number of trophic levels or the number of steps in a linear food chain.

For clupeoid fisheries of upwelling regions,  $n$  was assumed to be 1.5, implying some feeding directly upon phytoplankton. For oceanic fisheries the number would be larger, 3 to 5, as one plays games with this kind of an equation. You can make some pretty good guesses about what phytoplankton production is, but then one stumbles over what are the efficiencies of utilization. This point came up in Professor Isaacs' talk this morning in reference to the value of  $n$ . I agree with Professor Isaacs that  $n$  is probably not some simple integer like 2, 3, or 4.

What needs to be represented is that food chains are not linear and that the young of a carnivore may be herbivorous, that considerable cycling of energy may take place among the smallest size classes of planktonic organisms, that wastes may be eaten or absorbed, to related complexities. Certainly, the consumption of gametes, for example, mixes up the food web, as does cannibalism. True herbivory may be limited to laboratory cultures.

It is clear from the way that the fisheries scientists go about their work that it isn't just fish in general, or phytoplankton production in general, or copepod production in general that is interesting and useful, but rather the production of particular species. So I think it's time that the primary production field faced up to the need for understanding food webs at the species level, and this is the point that I would like to emphasize with a couple of examples.

Off of Southern California we occasionally have red tides. These are blooms of the phytoplankton that involve not more than a dozen species of dinoflagellates and usually one or two species are predominate, most frequently *Gonyaulax polyedra*, *Prorocentrum micans*, one of the *Ceratium* species, or *Gymnodium splendens*. One of the questions that one can ask is: Why do these species bloom and not diatoms?

To give a conception of the relative magnitude of things, a burst of upwelling off La Jolla can lead to either a bloom of diatoms or a bloom of dinoflagellates. If we get a bloom of diatoms, and we are measuring the standing stock of phytoplankton as chlorophyll, we rarely see chlorophyll levels more than about 15  $\mu\text{g}/\text{l}$ . On the other hand in the

dinoflagellate blooms, if we take a sample at the surface in mid-afternoon, we can see as much as 300  $\mu\text{g/l}$  of chlorophyll. What's going on? It has been known for a long time that these red tide dinoflagellates can undertake diurnal-vertical migrations and that they aggregate at the surface in the daytime, particularly from midday to mid-afternoon. This apparently accounts for the high concentration of chlorophyll and of cells that we see. The dinoflagellates can take advantage of nutrients in the upper 15 m or so of the water column whereas a diatom, with no independent locomotion of its own, is restricted to getting nutrients that are in the parcel of water immediate adjacent to it. So it is obvious that these vertically migrating dinoflagellates have a physiological idiosyncrasy in their vertical migration that allows them to sweep nutrients out of a rather larger parcel of water than diatoms can do. Dr. Lasker is going to talk about this in more detail tomorrow but it's of such significance in my view of the world that I'd like to mention it now.

He's been studying the feeding abilities of larval anchovies and finds that they will feed on certain of the dinoflagellates that are common in red tides. The physical size of the cell is apparently just right for the first feeding anchovy larvae and furthermore the aggregation abilities of these species allow high enough concentrations for the fish larvae to full their guts. It looks to me as if the idiosyncrasies of dinoflagellates in this regard may be of interest not only to phytoplankton people but to those concerned with the anchovy food web. I certainly hope it works out that way.

This brings up another point that I'd like to make (in leaving the flat earth society and joining the round earth society): that phytoplankton people can hope to interact more with people concerned with organisms at other trophic levels. Another peculiar set of phytoplankters that appear to be important in a particular food web is that of chain diatoms in the anchoveta food web in the Peru current. I'm told by Sra. Blanca Rojas de Mendiola, who studied the gut contents of the anchoveta in Peru, that the gut contents of the anchoveta over much of the year consists largely of the remains of diatoms and most of these are chain diatoms that form rather large particles. It is apparently these relatively large phytoplankton species that are of special interest. If one takes a water sample and counts all the phytoplankton in it, he finds that there is always a background of rather small celled phytoplankters and that numbers are variable for the chain diatoms. We need to know about the mechanisms that regulate the size and species composition of phytoplankton crops and why we see so much switching about of the dominant forms.

These two examples point out some idiosyncrasies among phytoplankton that make certain species or groups of species of particular interest to rather specific food webs. In the case of the chain diatoms,

their desirability seems to be based entirely on their size; at least we have no information beyond this. It's possible that their lipid composition or something else might also contribute. But it would appear that phytoplankton people could profitably amuse themselves by trying to collect information on physiological responses of some of these ecologically important species, and in fact this has been going on for years.

Earlier Curl and McLeod published a paper on *Skeletonema costatum*, a chain diatom, where they measured growth as functions of light, temperature and salinity. Braarud in Norway had been doing that even in the 40's. So there's a rather strong tradition in this area. I'm sure there must be other examples of this sort where the problem is not the overall production of phytoplankton but rather the production and success of either single species or small groups of species.

If one takes as his goal, at least for the purposes of this symposium, understanding something about marine food webs, then he is interested in the regulation of the population sizes and of the growth success of these rather discrete groups of phytoplankton. He should also be interested in their biogeographic distributions at the species level. There is a lot of work going on to examine, or to try to explain from laboratory studies with culture, why certain species of phytoplankton occur where they do, and why they are more abundant at one season of the year than the other. In this context I would like to mention that Ted Smayda at the University of Rhode Island and Bill Thomas in an analogous study of the eastern tropical Pacific, have been laboriously going through the dozen or so ecologically significant species in Narragansett Bay, collecting information on growth rate as a function of temperature, light, day length, and almost every other possible variable, trying to figure out why species X is abundant in January and February and species Y is abundant in March and April. This rather laborious kind of work, I think, has a future.

There is another area in which phytoplankton folks are contributing. Until now the contributions are related to the engineering models that I mentioned earlier. But it has been possible after 20 years of culturing things in the laboratory to draw some generalizations about the growth behavior of phytoplankton which allow one to make some rather sophisticated expectations as to how growth rate would vary as a function of temperature, light, and cell size, aspects such as Dick Dugdale showed in his slide for nitrate uptake versus light intensity, nutrient uptake versus concentration, and so forth. I should tell you what the list of these generalizations, so far conceived, consists of. First, there are the nutrient kinetics models and generalizations. Second, it has been found that sinking rate is a predictable function of the size of cells. Third, there is a rough relationship between the maximum

growth rate of the phytoplankton cell and its size. This maximum growth rate is that observed in cultures where the phytoplankton are hopefully growing under nearly optimal conditions. So far most of these generalizations are based upon size, and since size is of interest as far as feeding is concerned, then I think that perhaps they are useful.

In a recent paper Tim Parsons and Mac Takahashi wrote some equations taking into account these generalities in order to come up with some predictions as to what kinds of phytoplankters would be most successful in different oceanic environments, such as open ocean, coastal-temperate, coastal-tropical, and so forth. We seem to be getting to the point where we can make reasonable guesses as to what kinds of phytoplankters might be most successful in particular places. So these generalizations on phytoplankton behavior I think are a good thing and I know that they are of some use now to mathematical models of plankton production. I hope that they will become more useful as, first of all, they get "debugged" a bit and as people become more aware of them.

There is another role for phytoplanktologists that is a little bit different and more traditional, along the lines of investigating metabolic processes that are of ecological significance. Dick Dugdale mentioned one this morning, the repression by ammonia of the assimilation of nitrate. It seems to be a general phenomenon. There may be some peculiar idiosyncrasies in that area, as among the red tide dinoflagellates. We're going to have a look and see, but, for all practical purposes, this seems to be a universal thing of some usefulness if one is concerned with phytoplankton growth about sewage outfalls or other highly eutrophic waters.

Some other metabolic processes are not so well known but may influence overall production. There is a phenomenon studied most among higher plants called photo-respiration. It has been discovered that most crop plants, such as wheat, waste much of their photosynthetic energy at high light intensities. They fix carbon but instead of it going through the Calvin cycle and coming out as sugars and starch food reserves, some of the carbon is shunted off as glycolic acid. Since the energy in the carbon-to-carbon bonds is not conserved in that pathway, it appears to be a hopelessly wasteful phenomenon. We would like to know if that sort of thing goes on in the ocean. Efforts are underway to see whether phytoplankton grown in a laboratory show this photo-respiration and to determine whether it is important in the ocean. I should note that among higher plants there are some significant crop plants that do not have photo-respiration, and they are more productive than the ones that do have it. For example, corn and sugar cane do not have photo-respiration and the maximum yield per acre for those two crop plants

exceeds that of wheat, rye, and tobacco that show photo-respiration.

Another phenomenon at the physiological level of investigation concerns the inhibition of photosynthesis, and as you saw this morning, nitrate-uptake at high light intensities. If one plots photosynthesis as a function of depth, most of the graphs show a suboptimal rate at the sea surface. This may seem to be a trivial problem but I suppose as much as 10 or 20% of primary production is "on the line" depending on whether you think the effect is valid or that it is an artifact.

A number of people think it is an artifact of putting things in bottles. Phytoplankters held in bottles at the sea surface can no longer participate in the wave-induced, Langmuir circulation that would normally expose them to a range of light intensities. Being held in continuous bright light is somewhat unnatural. Other people think that it is a real effect related to the ultraviolet portion of the electromagnetic spectrum and that there is UV inhibition of photosynthesis. We'll find out in a year or so when people start publishing their results.

Another metabolic process of considerable interest is the fixation of nitrogen. As you know, N-fixation is significant among bacteria that form nodules on the roots of legumes, alder trees, and so forth. So far only a very few species of phytoplankton have been identified from the ocean that can fix nitrogen and these are blue-green algae. One of them, *Trichodesmium*, has been known for a long time, and Dugdale and Goering did the pioneering study of its N-fixation in the Sargasso Sea. Another N-fixing blue-green algae that Tim Mague in the Food Chain Group and Venrick have been studying in the Pacific is an intracellular endosymbiont called *Richelia* which occurs inside the cells of the diatom *Rhizosolenia*. Inasmuch as this nitrogen fixation is a source of new production and doesn't represent just the recycling of what nitrogen is already there, it is a significant and important phenomenon. Mague tried to estimate how much nitrogen fixation went on in the central Pacific compared with the assimilation of recycled ammonia and urea and he found that it was perhaps 10 or 20% of the total nitrogen turnover in the summertime. It is my understanding that this nitrogen fixation is limited in the summertime.

The approaches that appear interesting at the moment for extending our knowledge are first of all to turn away from the concept of linear food webs and to start paying more attention to individual species and groups of species. So far this looks interesting in terms of size categories of phytoplankton, separating phytoplankton into size groups, large ones, small ones, and so forth. For dinoflagellates not only size appears to be important in their blooms but their vertical migration behavior also seems to be of ecological significance since this



leads to aggregations of cells in sufficient concentrations for successful grazing of animals.

People have recognized for years that there is a general relation between the production of fish in an area and the primary production or the nutrient input rate. We know that the coastal Peru fishery, except during El Niño years, is characterized by high rate of nutrient input, high phytoplankton stocks, and high production of fish. We know that in the middle of the Pacific the converse is true.

Bill Sutcliffe at the Bedford Institute has sent me some reprints that are rather speculative attempts to show that this kind of comparison or this kind of phenomenon might be more important in fisheries where it's never really been looked at before, and I can tell you briefly what he's done. He has taken data on the flow of the St. Lawrence River over the years and by proper statistical fudges, averaging 3 year means and so forth, he finds that there is a

relationship between the flow of the St. Lawrence and the catch of some of the New England commercial fisheries, lobster and some others. I'm certainly not qualified to determine whether these statistical correlations that he has are viable and will stand the test of time, but they're pretty interesting. His argument is that the greater the river flow, the more of the underlying, nutrient-rich water is entrained in the flowing fresh water carried out to sea. The nutrient input to the coastal waters off northern New England would then be almost directly related to the river flow. Of course he must lag the lobster catch 4 or 5 years after this nutrient input related to river flow to account for the time it takes for the lobster to grow to commercial size. The implication is, if this lag is justified, that the survival of the larvae and juveniles is closely tied to nutrient input.

# AN EXPERIMENTALIST'S VIEW OF ZOOPLANKTON MODELS

MICHAEL M. MULLIN

Institute of Marine Resources  
University of California, San Diego  
La Jolla, California 92037

## ABSTRACT

The experimentalist can perhaps determine an appropriate mathematical relationship between particular environmental parameters and a metabolic or behavioral response of zooplankton in the laboratory. Small scale distributions of zooplankton in nature must then be studied over time to determine the parameters which different animals actually experience. The heterogeneous and probabilistic nature of the pelagic environment is in contrast to the homogeneous, deterministic approach taken in most models.

## INTRODUCTION

My purpose here is not to exacerbate any intellectual tensions between experimentalists and theorists, but rather to indicate some general problems whose solutions would be of interest to advocates of both approaches. I am concerned primarily with those models in which the several underlying processes which regulate biomass or size of population are described mathematically, and these mathematical formulations are then combined in such a way that spatial or temporal patterns of biomass or size of population may be "predicted" from a set of relatively routine measurements of environmental parameters. The usual goal of such models is not just to predict patterns or events, but to do so from *a priori* knowledge and description of causal relationships, so that successful prediction implies some understanding.

It will be obvious that the difficulties I will illustrate are by no means peculiar to models of the zooplankton, or even to the pelagic environment. What may be peculiar is that the major problem in modeling the dynamics of zooplankton may not be so much in documenting the necessary equations as in verifying a particular model through field data. First, the zooplankton is a very heterogeneous group, defined operationally by the gear used for capture rather than by a discrete position in the food web. In this respect, the zooplankton is a much less "natural" grouping than the phytoplankton, both conceptually and analytically. Second, the zooplankton is patchy in horizontal and vertical distribution, as are the component species; this patchiness exists on several spatial scales, and is not always obviously related to physical parameters. Third, the zooplankton moves horizontally with currents and vertically through diel migrations of the older developmental stages of some species. All this means that the interpretation

of sequential samples is fraught with difficulty, and that spatial and temporal patterns can only be determined with great imprecision. Hence, verification of a particular model, or distinguishing between two models which lead to slightly different predictions, may have to rest not on the predictions concerning the dynamics of zooplankton but on predictions of other properties (e.g. dissolved nutrients) which can be measured with greater precision. (Steele and Mullin, in press).

## FORMULATIONS

Returning to models themselves, I would categorize one set of difficulties by the following question: What mathematical formulation should be used to describe the relationship between a particular environmental parameter and the zooplankton? As an illustration, consider the effect of temperature on a metabolic rate such as ingestion or growth. A general relationship of such a rate ( $R$ ) to the bodily weight ( $W$ ) of an individual animal is given by  $R = aW^b$  (or, as a weight-specific rate,  $R/W = aW^{b-1}$ ) where  $a$  and  $b$  are constants. Values of  $b$  for respiration of zooplankton are summarized by Conover (1968) and Marshall (1973). It is usually assumed that temperature affects the value of  $a$  and not that of  $b$ , although some studies (e.g. Ikeda, 1970; Champalbert and Gaudy, 1972) have suggested that the value of  $b$  for respiration also depends on environmental temperature.

In an empirical approach, Comita (1968) has used a multiple regression equation to describe the experimentally determined respiratory rates of freshwater copepods, in effect using an exponential function of temperature to replace  $a$ , and Conover (1968) found that the same equation gave reasonably good estimates of the respiratory rates of much larger, marine copepods.

In many physiological studies, the effect of temperature has been expressed as  $Q_{10} = (R_2/R_1)^{10/(t_2-t_1)}$ , where  $R_2$  and  $R_1$  are rates at temperatures  $t_2$  and  $t_1$  ( $^{\circ}\text{C}$ ), respectively. Hence, assuming that  $b$  is independent of temperature, a general expression for any metabolic rate could take the form:

$$R_{w,t} = c(Q_{10}^{(0.1t-1)})W^b \quad (1)$$

where  $c$  is a constant giving the metabolic rate of an animal of unit weight at  $10^{\circ}\text{C}$ . The chief difficulty with this formulation is that  $Q_{10}$  is not a true constant, but itself varies somewhat with

temperature (e.g. Comita, 1968) and is dependent upon the state of acclimation (i.e. the previous exposure to temperature) of animals used in an actual measurement.

McLaren (1963) reviewed several formulations for the effect of temperature on metabolic rates and strongly urged the use of Belehrádek's equation, of which the classical "normal curve" of Krogh is a special case. This equation has the form,  $R = g(t - \alpha)^h$ , where  $g$  and  $h$  are constants governing mean slope and degree of curvature of the relationship, and  $\alpha$  is a "biological zero" which in effect shifts the scale of temperature. This constant also reflects the state of acclimatization. The constant ( $g$ ) is dependent on the metabolic process being studied, and for copepod eggs at least, appears also to vary with diameter, i.e. proportional to  $W^{0.3}$  (McLaren, 1966; Corkett and McLaren, 1970; Corkett, 1972). If this proves to be generally true, a modified equation might then take the form:

$$R_{w,t} = k(t - \alpha)^h W^{b+0.3} \quad (2)$$

where  $k$  is a constant incorporating  $g$  and the metabolic rate of an animal of unit weight,  $a$ .

Another classical equation not common in the literature on zooplankton but recently used to describe the maximal rate of growth of phytoplankton (Goldman and Carpenter, 1974) is  $R = ue^{-v/T}$ , where  $u$  is a rate constant and  $-v$  is the slope of an Arrhenius plot of the natural logarithm of the rate ( $R$ ) against the reciprocal of the absolute temperature ( $1/T$ ). It is doubtful that this formulation represents any improvement over those given above, since it contains no term for acclimation.

In using these formulations, one could assume that temperature affects all metabolic processes to the same degree so that the ratio of two metabolic rates for a given zooplankter is equal to the ratio of the respective constants  $c$ ,  $k$ , or  $u$ . In fact, if temperature has a differential effect on metabolic rates, then ratios such as the gross efficiency of growth (= growth/ingestion) may vary with temperature (compare Mullin and Brooks, 1970; Reeve, 1963; and Reeve, 1970 for contradictory results concerning the dependence of this efficiency on temperature for zooplankton).

The same type of difficulty is encountered when one attempts to formulate the rate of ingestion by a zooplankter as a function of the concentration of food it experiences, even in the most simple case in which only one type of food is present. Possible equations are:

$$I = I_m(P - P_o) / (S - P_o) \quad \text{for } P_o \leq P \leq S \\ = I_m \quad \text{for } P > S \quad (3)$$

$$I = I_m(1 - e^{-(P - P_o)/\delta}) \quad (4)$$

$$I = I_m(P - P_o) / (K + P - P_o) \quad (5)$$

which are derived from slightly different

mechanistic descriptions of the feeding process. In each, the rate of ingestion ( $I$ ) is described in terms of a maximal rate ( $I_m$ ) and the biomass of phytoplankton ( $P$ ). In all cases, there is the possibility that a threshold biomass ( $P_o$ ) is necessary to stimulate feeding, i.e.  $I = 0$  for  $P \leq P_o$ . In the rectilinear equation (3), the rate of ingestion increases linearly with increasing biomass of food to some saturating value,  $S$ , and is constant thereafter. In the Ivlev equation (4), the constant  $\delta$  determines the initial slope of the curvilinear relationship, and  $K$  has the same function in the Michaelis-Menten equation (5).

Equation 3, 4, or 5 may be combined with equation 1 or 2 in the simplest way by setting  $I_m = R_{w,t}$ . However, Frost (1972) and McAllister (1970) demonstrated that  $I_m$  determined over a short experimental period is a function of whether the zooplankters were well fed or starved at the beginning of the experiment. Further, data given by Frost (1974) and Ambler and Frost (1974) suggest that  $S$ ,  $\delta$ , and  $K$  are inverse functions of the relative sizes of the particles being eaten and the zooplankter.

In an attempt to determine the best formulation for ingestion, Mullin, Stewart and Fuglister (1975) fit equations 3, 4 and 5 to data of Frost (1972), the most extensive in the literature. Equation 3 fit the data slightly better than did the other two equations, but it could not be proven statistically to remove more of the variance. That is, one could not distinguish with statistical confidence between the formulations, in spite of the large amount of data. More important for modeling was the finding that the choice of equation 3 would lead to the conclusion that there was no threshold for feeding, i.e.  $P_o = 0$ , while use of equation 4 or 5 would result in  $P_o > 0$ . The concept of a threshold is teleologically attractive because it provides the phytoplankton with a "refuge in low density" so that the plants cannot be grazed to extinction (e.g. Steele, 1974), and because the zooplankters seem to cease expending energy in the pursuit of food when it becomes unprofitable to do so.

These examples may prove to be trivial; perhaps any exponential function relating metabolism to temperature and any quasi-hyperbolic function relating ingestion to availability of food will be sufficient to model the dynamics of zooplankton. In nature, however, the zooplankters confront an array of particles of potential food differing in size, shape, degree of defensive armament, and nutritive value, and it is far from certain that ingestion can then be described using only equation 3, 4, or 5 determined for single types of food independently.

#### PATCHINESS

Having belabored the point that a variety of formulations for the relationships between

parameters are possible, and perhaps cannot be distinguished, I turn to a second, more fundamental question: Assuming that one can decide upon deterministic formulations to describe the impingement of environmental parameters on a zooplankter or the zooplankton generally, what values of the parameters do the animals actually experience? This is a question of small scale distributions which change with time. Clearly the metabolic rates of a zooplankter which migrates through a thermocline twice a day may be profoundly affected by temperature (cf. McLaren, 1974), and this behavior requires that at least a weighted mean temperature be used in equation 1 or 2, and perhaps even this is an unjustified simplification.

More perplexing may be the value of P to use in equation 3, 4, or 5. One must first decide what portion of the spectrum of particles present in the sea really constitutes "food" in terms of the responses of the zooplankter. This portion could range from the biomass of a particular species of phytoplankton to the total particulate organic carbon, to take the extremes.

Furthermore, phytoplankton often occurs in patches or layers (e.g. Strickland, 1968). (I will here use the term "patch" to mean a volume of water containing an anomalously high biomass, but do not mean to imply that patches have discrete boundaries.) If patches of abundant phytoplankton and zooplankton occur together, the average biomass of phytoplankton in the euphotic zone (as determined by integrating a profile of chlorophyll sampled at discrete depths, for example) may seriously underestimate the value of P which is relevant for the zooplankton.

Mullin and Brooks (1972) determined the small scale distributions of phytoplankton biomass and juvenile copepods in relatively homogeneous coastal waters at six stations off Southern California. The important elements of this study were: 1) That the abundances of both plants and animals were integrated simultaneously in the same volume of water, and this volume (150 l) was "reasonable" with respect to the likely scale of short-term wanderings of a juvenile copepod; 2) Any tendency towards aggregation of the juvenile copepods in layers or patches of abundant phytoplankton could be distinguished from aggregation at a particular depth in response to some physical parameter. The juvenile copepods were more abundant, both horizontally and vertically, where the biomass of phytoplankton was higher. In this particular case, 66% of the population of juvenile copepods was found in those samples containing greater than average concentrations of phytoplankton, and these samples were 33% of the total volume of water sampled. Stated another way, the "average" zooplankter was experiencing a concentration of

food (assuming phytoplankton biomass represents food) which was higher than average, and could find this condition in only a third of the potential living space. The half of the samples in which the concentrations of phytoplankton were higher than the median concentration also contained 89% of all the juvenile copepods.

Although high concentrations of juvenile copepods and phytoplankton tended to occur together in this one study, we still have not determined the temporal coherence of this co-occurrence. That is, how long does a patch of phytoplankton persist before it is eroded by turbulence and/or grazing, and how long does the same group of zooplankters remain within such a patch (i.e. how important are immigration and emigration from a patch, either due to swimming or to physical processes)? If there is considerable active movement of animals into and out of persistent patches of phytoplankton, or if the phytoplankton patches are ephemeral, then all the individual zooplankters of a given species and age are equivalent and have a similar probability, over time, of finding food. If active movement is trivial and the patches persistent, however, then there are subpopulations of zooplankton, the "ins" and the "outs", which may have different dynamics. In particular, the "outs" will probably have a slower rate of growth and a higher mortality than the "ins", either because of outright starvation (if the "non-patch" biomass of phytoplankton is very low) or because, growing more slowly, they will remain longer in the early juvenile stages which are most vulnerable to predation. In the extreme case, a model might be most successful if it was focused upon the dynamics of the "ins" and ignored the "outs", except as food for predators (which, being thus well nourished, might then attack the "ins" in a second order interaction).

One of the curious aspects of the co-occurrence of patches is that the animals' grazing tends to reduce drastically the high biomass of phytoplankton. Hence, there is undoubtedly some probability distribution of four types of areas in the euphotic zone: 1) Areas where both phytoplankton and zooplankton are rare, and perhaps a bloom of phytoplankton may start; 2) Areas where the phytoplankton has become abundant and may have temporarily exhausted nutrients but is not heavily grazed; 3) Areas where both phytoplankton and zooplankton are abundant and rates of mortality of phytoplankton and ingestion and growth by zooplankton are high; and 4) Areas where only the zooplankton is abundant, perhaps having grazed down the phytoplankton and now being semistarved. What I am suggesting is a spatial mosaic of the elements of the classical temporal pattern of a spring bloom. A realistic model would have to take a probability distribution of this sort into account, but

in many present models it is assumed that the processes occur deterministically at approximately the same rates over a fairly large horizontal area at any one time.

### COMMENT

I hope it is clear that I do not intend to denigrate modeling as an intellectual or utilitarian pursuit by discussing these problems. Through the necessary simplification of natural processes, and particularly through sensitivity analysis, models aid in indicating the important questions for future research, quite aside from their potential value as predictive tools for management of the marine environment. Ideally, a model leads to conclusions which are not intuitively obvious, and we then learn from the reconciliation of the model and our collective intuition. Indeed, models provide the best possible excuse for those of us who enjoy working with living, aesthetically pleasing animals, or who come to appreciate the comradeship of going to sea.

### ACKNOWLEDGMENT

During the preparation of this essay, I have been stimulated by discussions with John Steele concerning zooplankton models, and with Paul Smith concerning distributions, and I have "borrowed" extensively from them both. Any conceptual errors or pedantic flaws are, of course, my own. Financial support was provided by U.S. Energy Research and Development Agency Contract No. AT(11-1)GEN 10, P. A. 20.

### REFERENCES

- Ambler, J. W., and B. W. Frost, 1974. The feeding behavior of a predatory planktonic copepod, *Tortanus discaudatus*. *Limnol. Oceanogr.*, 19: 446-451.
- Champalbert, C., and R. Gaudy, 1972. Étude de la respiration chez copépodes bathymétriques variés dans la région sud marocaine et canarienne. *Mar. Biol.*, 12: 159-169.
- Comita, G. W., 1968. Oxygen consumption in *Diatomus*. *Limnol. Oceanogr.*, 13: 51-57.
- Conover, R. J., 1968. Zooplankton—life in a nutritionally dilute environment. *Amer. Zool.*, 8: 107-118.
- Corkett, C. J., 1972. Development rate of copepod eggs of the genus *Calanus*. *J. Exp. Mar. Biol. Ecol.*, 10: 171-175.
- Corkett, C. J., and I. A. McLaren, 1970. Relationships between development rate of eggs and older stages of copepods. *J. Mar. Biol. Ass. U.K.*, 50: 161-168.
- Frost, B. W., 1972. Effects of size and concentration of food particles on the feeding behavior of the marine planktonic copepod *Calanus pacificus*. *Limnol. Oceanogr.*, 17: 805-815.
- , 1974. Feeding processes at lower trophic levels in pelagic communities. p. 59-77. *In The Biology of the Oceanic Pacific*, Proc. 33rd Ann. Biol. Coll., C. B. Miller, ed., Oregon State Univ. Press.
- Goldman, J. C., and E. J. Carpenter, 1974. A kinetic approach to the effect of temperature on algal growth. *Limnol. Oceanogr.*, 19: 756-766.
- Ikeda, T. 1970. Relationship between respiration rate and body size marine plankton animals as a function of the temperature of habitat. *Bull. Fac. Fish. Hokkaido Univ.*, 21: 91-112.
- Marshall, S. M., 1973. Respiration and feeding in copepods. *Adv. Mar. Biol.*, 11: 57-120.
- McAllister, C. D., 1970. Zooplankton rations, phytoplankton mortality and the estimation of marine production. p. 419-457. *In Marine Food Chains*, J. H. Steele, ed., Oliver and Boyd.
- McLaren, I. A., 1963. Effects of temperature on growth of zooplankton and the adaptive value of vertical migration. *J. Fish. Res. Bd. Canada*, 20: 685-727.
- , 1966. Predicting the development rate of copepod eggs. *Biol. Bull.*, 131: 457-469.
- , 1974. Demographic strategy of vertical migration by a marine copepod. *Amer. Nat.*, 108: 91-102.
- Mullin, M. M., and E. R. Brooks, 1970. Growth and metabolism of two planktonic marine copepods as influenced by temperature and type of food. p. 74-95. *In Marine Food Chains*, J. H. Steele, ed., Oliver and Boyd.
- , 1972. The vertical distribution of juvenile *Calanus* (Copepoda) and phytoplankton within the upper 50 m of water off La Jolla, California. p. 347-354. *In Biological Oceanography of the Northern North Pacific Ocean*, A. Y. Takenouti, ed. Idemitsu Shoten.
- Mullin, M. M., E. F. Stewart, and F. J. Fuglister, 1975. Ingestion by planktonic grazers as a function of the concentration of food. *Limnol. Oceanogr.*, 20: 259-262.
- Reeve, M. R., 1963. Growth efficiency of *Artemia* under laboratory conditions. *Biol. Bull.*, 125: 133-145.
- , 1970. The biology of Chaetognatha I. Quantitative aspects of growth and egg production in *Sagitta hispida*. p. 168-189. *In Marine Food Chains*, J. H. Steele, ed., Oliver and Boyd.
- Steele, J. H., 1974. The Structure of Marine Ecosystems. Harvard Univ. Press, 128 p.
- Steele, J. H., and M. M. Mullin, in press. Zooplankton Dynamics. *In The Sea*, Vol. VI. Wiley-Interscience.
- Strickland, J. D. H., 1968. A comparison of profiles of nutrient and chlorophyll concentrations taken from discrete depths and by continuous recording. *Limnol. Oceanogr.*, 13: 388-391.

# DENSITY DEPENDENCE OF CATCHABILITY COEFFICIENT IN THE CALIFORNIA PACIFIC SARDINE, *SARDINOPS SAGAX CAERULEA*, PURSE SEINE FISHERY

ALEC D. MacCALL

California Department of Fish and Game  
Southwest Fisheries Center  
La Jolla, California 92038

## ABSTRACT

The California Pacific sardine fishery is examined for the period 1932 to 1950 to determine if the catchability coefficient, based on available measures of fishing effort, varied as a function of population size. Previous estimates of sardine fishery parameters indicate such a density dependence. New estimates of instantaneous fishing mortality rates and mean population sizes were calculated. Annual mean boat tonnages for the fleet were calculated and show a growth in mean effective vessel capacity from about 60 tons in early 1930's to 120 tons in 1946. To account for changes in efficiency of the fleet due to increases in vessel size, fishing effort in boat-months was converted to effort in ton-months. Two catch per unit effort indices of abundance, one unstratified by geographical area and one stratified into northern and southern segments of the fishery, gave very similar results. Estimates of the catchability coefficient for the sardine fishery were found to be inversely related to population abundance,  $N$ , and fit the power function  $q = \alpha N^{\beta}$ , with  $\beta = -0.611$  for the period 1937-1944 when the fishery was least restricted and gear improvements were minimal.

## INTRODUCTION

John Radovich (1973) recently hypothesized that the California fishery for the Pacific sardine experienced an increase in catchability coefficient as biomass decreased. This increase was presumably the result of the combined effects of behavior of the fish, which tended to maintain contagiously distributed schools of fishable size despite decreased total biomass, and nonrandom characteristics of the local purse seine fleet which was highly mobile, informed, and efficient. Similar relationships are suspected in other purse seine fisheries, particularly the northwest Atlantic menhaden fishery (Schaaf and Huntsman, 1972). Gulland (1964) voices serious doubts over the usefulness of most measures of effort in purse seine fisheries, and Ostvedt (1964) shows for the Norwegian winter herring fishery that purse seine catch per unit effort (CPUE) is considerably less sensitive than gill net CPUE to changes in herring abundance. Pope and Garrod (1975) have shown the catchability coefficient to be inversely related to stock size in three northwest Atlantic cod

fisheries, including two independent trawl fisheries and the Portuguese dory fishery. A model of purse seine catch and effort developed by Paloheimo and Dickie (1964) predicted a catchability coefficient inversely related to stock abundance resulting in constant CPUE.

Murphy (1966) calculated catchability coefficients and population sizes of Pacific sardines based on a cohort analysis of commercial catches. A plot of catchability coefficients against biomass estimates (Figure 1) shows a distinct rise in catchability coefficient as biomass decreases. This interpretation requires further investigation. There is a strong serial relationship in the increase in catchability which may have been related to the entry of progressively larger vessels into the sardine fleet (Clark, 1939). Clark's (1956) effort, on which Murphy's estimates are based is measured in boat-months, and is insensitive to this change in mean hold capacity. Marr (1950) shows that fishing power of sardine vessels in Oregon and Washington was highly correlated with boat length. A similar relationship is likely to hold for California vessels. If effort units are recalculated for the California sardine fleet, a recalculation of Murphy's (1966) fishing mortality rate estimates, which were based on Clark's CPUE, is desirable. Moreover, the recalculation can take the form of Tomlinson's (1970) generalization of the method, which estimates fishing mortality rates directly from catches.

This investigation was pursued with the purpose of determining if a correlation existed between the catchability coefficient and abundance of Pacific sardines. Since the sardine can no longer support a large fishery in California, the specific problem is of little direct relevance though it may be used as a model for other fisheries. Exploitation of other species by purse seine gear is increasing in California as well as in many other areas, and elucidation of the behavior and dynamics of purse seine fisheries in general may be of value to their management.

## METHODS

Data used in this study are restricted to the fishing seasons between 1932 (1932-33) and 1950 (Table 1). The 1932 season is the earliest for which estimates of effort and fishing mortality rates are available. Clark (1939) felt that this was the earliest season for which

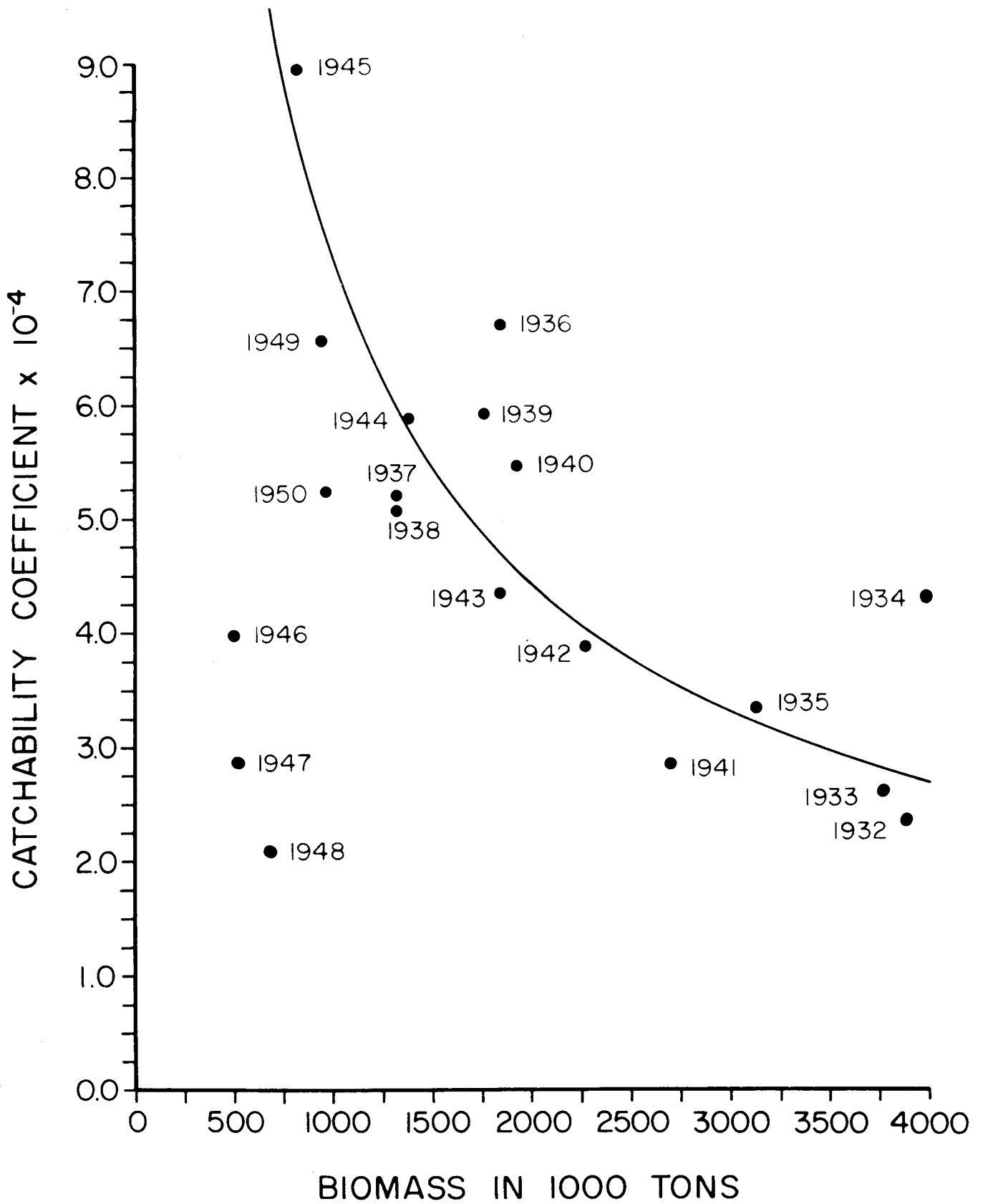

FIGURE 1. Catchability coefficient as a function of population size (data from Murphy, 1966, Tables 11 and 15).

cannery limits on deliveries ceased to be a major factor in reducing fishing power. Starting in 1951, Murphy (1966) increased his estimate of natural mortality rate from  $M = 0.4$  to  $M = 0.8$ , making it difficult to compare fishing mortality rates with the earlier period. Moreover, gear developments in the late 1940's and early 1950's undoubtedly changed the

fishing power of sardine vessels. Use of radio, depth finders, and aerial scouting was well established by the early 1950's (Knaggs, 1972). Presumably, the period 1932-50 was relatively free from increases in fishing power due to innovation and gear development.

TABLE 1  
Pacific Sardine Fishery Parameters

Year	Fishing mortality rate $F_1$ (Murphy, 1966)	Recalculated fishing mortality rate $F_2$	Effort $f_1$ boat-months (Clark and Daugherty, 1952)	Number of boats examined	Mean boat tonnage	Effort $f_2$ ton-months	Catchability $q = F_2/F_1$ ( $10^{-6}$ )	Mean fished population age 2+ ( $10^6$ )
1932-33	0.105	0.10	448.1	80	59.66	26734	3.74	17033
1933	0.156	0.15	600.2	80	57.91	34758	4.32	14242
1934	0.307	0.31	716.6	115	57.86	41462	7.48	12254
1935	0.292	0.28	876.1	145	51.27	44918	6.23	13326
1936	0.825	0.69	1236.9	163	71.18	88043	7.84	7115
1937	0.707	0.65	1366.4	178	80.39	109840	5.92	5491
1938	0.708	0.60	1399.0	178	86.98	121680	4.93	6794
1939	0.775	0.55	1314.4	213	89.89	118150	4.66	7233
1940	0.613	0.55	1124.5	176	90.79	102090	5.39	6251
1941	0.370	0.36	1304.0	199	94.10	122710	2.93	15504
1942	0.390	0.35	1010.3	143	95.90	96890	3.61	11654
1943	0.485	0.49	1121.7	151	96.92	108720	4.51	7224
1944	0.765	0.74	1304.8	151	104.71	136630	5.42	5003
1945	1.170	1.03	1314.7	170	115.92	152400	6.76	2666
1946	0.589	0.52	1485.0	182	121.05	179760	2.89	2270
1947	0.389	0.39	1358.4	224	72.51	98500	3.96	1900
1948	0.192	0.23	921.0	248	65.74	54160	4.25	5085
1949	0.619	0.60	946.8	280	58.25	44810	13.39	4292
1950	0.796	0.796	1526.8	287	54.19	103830	7.67	3277

### Density-Dependent Catchability

The model proposed to describe the density-dependent variability of the catchability coefficient is:

$$q = \alpha N^\beta \quad (1)$$

where:  $q$  is catchability coefficient,

$N$  is mean population size or abundance, and  
 $\alpha$  and  $\beta$  are constants.

This power function allows the catchability coefficient to increase or decrease as abundance varies, depending on the sign of  $\beta$ .

Given

$$C = qfN$$

where:  $C$  is catch in numbers and  
 $f$  is nominal effort, then

$$q = (C/f)N^{-1} \quad (2)$$

and setting equations (1) and (2) equal, we obtain

$$(C/f)N^{-1} = \alpha N^\beta \text{ or} \\ C/f = \alpha N^{\beta+1} \quad (3)$$

This indicates that if  $\beta = 0$ ,  $\alpha = q$  and CPUE is a perfect index of abundance. However, if  $\beta = -1$ ,  $\alpha = C/f$ , and CPUE is a constant which is entirely useless as an index of abundance. This is the case predicted by Paloheimo and Dickie (1964). For values of  $\beta$  other than 0 or  $-1$ , CPUE bears a curvilinear relationship to abundance and may be of use as an abundance index after appropriate correction; but for values of  $\beta$  near  $-1$ , information

content of CPUE indices is greatly reduced and they must be used with caution.

Values of  $\beta$  can be obtained from fitting a production model to catch and effort data by a procedure developed by Fox (National Marine Fisheries Service, MS) or by directly calculating  $q$  from fishing mortality rates ( $F$ ) and effort, and regressing these values on abundance estimates after log transformation. Since both variables are subject to an unknown measurement error, the best regression line was obtained by calculating the geometric mean of individual slopes obtained by  $Y$  on  $X$ , and  $X$  on  $Y$  linear regressions (Ricker, 1973). Fox obtains a  $\beta$  of  $-0.3$  for the Pacific sardine fishery for 1932 to 1954, while the regression method gives a  $\beta$  of  $-0.608$  for 1932 to 1950 based on Murphy's (1966) estimates; however, deletion of the 1946-48 outliers (a justification is given later) increases the statistical significance greatly and the estimate of  $\beta$  becomes  $-0.724$  (Table 2). Statistical variability and bias is poorly known for either method, making comparison of  $\beta$  values difficult. A well known statistical problem arises in the regression method: regression of a variate  $Y/X$  on  $Z/Y$  (in this case  $F/f$  on  $C/F$ ) may give a seemingly significant correlation despite  $X$ ,  $Y$  and  $Z$  being entirely random, due to  $Y$  appearing in the numerator of the first term and in the denominator of the second. The degree to which this biases the results of the regression method is unknown in this case, but it is assumed to be minor.



The regression method will be assumed to give the best estimate of  $\beta$  for the purposes of this investigation. It is important to note that in this case  $\beta$  is near the critical value of  $-1$  where CPUE is constant regardless of abundance.

TABLE 2  
Regression Estimates of Density-Dependent Catchability Parameters for Pacific Sardine

Source	n	$\alpha$	$\beta$	r
Murphy (1966) data*				
1932-1950.....	19	2.501	-0.608	-0.215
1932-45, 1949-50.....	16	16.05	-0.724	-0.826
Recalculation†				
Unstratified				
1932-45, 1949-50.....	16	16.78	-0.656	-0.605
1932-36.....	5	4.911	-0.610	-0.979
1937-44.....	8	78080	-1.005	-0.795
Stratified				
1932-45, 1949-50.....	16	77.48	-0.719	-0.695
1937-44.....	8	1029	-0.841	-0.896

\* Effort in boat-months, population size in tons age 2+ at beginning of season.  
† Effort in ton-months, population size in mean number age 2+ during season.

**Estimation of Fishing Mortality and Population Size**

Estimates of fishing mortality rates were recalculated from Murphy's (1966) catches by the cohort analysis method described by Tomlinson (1970). Fish were assumed to be fully recruited at age 3, and catch ratios ( $C_{4+}/C_{3+}$ ) were used to obtain exploitation rates in a backward solution starting with  $F_{1950} = 0.796$  which is identical to Murphy's  $F_{1950}$ . An  $M$  of 0.4 was assumed. Recalculated fishing mortality rates (Table 1) correspond clearly to those obtained by Murphy (Figure 2), with large discrepancies only for the series 1936 to 1940, and for 1945 and 1946. Errors in  $F$  are propagated from season to season in cohort analysis, but with a tendency for those errors to be reduced at each iteration in the backward solution (Tomlinson 1970).

Use of mean population sizes should reflect the average abundance of fish observed over the course of the fishing season better than would the initial population sizes at the beginning of the season. Annual mean available population sizes (Table 1) were obtained from  $F$  estimates by the relationship:

$$N' = C_t / F \tag{4}$$

where:  $N'$  is mean available population, and

$C_t$  is total annual catch of all age groups.

$N'$  will be used for quantity  $N$  in equation (1), since it can be interpreted as the size of that population necessary to give the observed catch if all individuals are fully recruited. This could be interpreted as the population fully available to the fishery.

**Effort Adjustment for Vessel Size**

The possible influence of increases in fishing power resulting from increasing effective hold capacity of the average boat used by Clark and

Daugherty (1952) was removed by converting effort to ton-months. Estimated sardine carrying capacity of boats was derived from an empirical relationship relating skipper's estimates of carrying capacity to registered gross tonnage for 27 vessels active in the present San Pedro wetfish purse seine fleet. (Data supplied by Knaggs, California Department of Fish and Game, pers. comm.). The relationship

$$T = 1.003G + 1.349 \times 10^{-7}G^4$$

where:  $T$  is estimated sardine carrying capacity (short tons), and

$G$  is registered gross tonnage

appears to fit the observations (Figure 3) quite well ( $r = 0.997$ ), and should be valid for estimating approximate carrying capacity of boats within the general range of observed gross tonnages. Of 451 boats for which estimates were made, 41 exceeded 126 gross tons, and of those only 11 exceeded 150 gross tons.

Mean sardine capacity of the average boat in the fleet was calculated for each season as average estimated vessel capacity weighted by boat activity measured in months fished (Table 1). Average tonnages show a distinct rise from the mid 1930's to the mid 1940's (Figure 4). From 1932 through 1936 and 1945 through 1948, canneries are known to have imposed limits on the size of deliveries, thereby reducing the effective boat tonnage. For the latter period, a boat was assigned the limiting value of tonnage for ports and months in which limits were imposed if boat tonnage exceeded the limit. Clark (1939) gives some information on limits in effect from 1932 through 1936. The information is insufficient to calculate effective boat tonnages as above, but allows an estimate for each season to be made by a weighted mean based on boat activity:

$$\bar{T}_{est} = \frac{\sum B_i (f_{lim} \bar{T}_{lim} + (1 - f_{lim}) \bar{T}_{tot})}{\sum B_i} \tag{5}$$

where:  $\bar{T}_{est}$  is estimated effective tonnage for season,  $B_i$  is number of boats operating respectively in Monterey fall and winter and San Pedro fall and winter fisheries (Clark, 1939, Tables 3 and 4),

$f_{lim}$  is the fraction of time limits were in effect (Clark, 1939, Table 1),

$\bar{T}_{lim}$  is average effective boat tonnage under the influence of limits. Boats with carrying capacities larger than the mean limit for the season (Clark, 1939, Table 1) were assigned the mean limit as their effective tonnage, and

$\bar{T}_{tot}$  is average effective boat tonnage in the absence of limits.

This assumes the size distribution of vessels in the Monterey and San Pedro fall and winter subdivisions was equal, since more specific information is lacking.

Effort in ton-months was calculated by multiplying Clark and Daugherty's (1952, Table 6) all-California

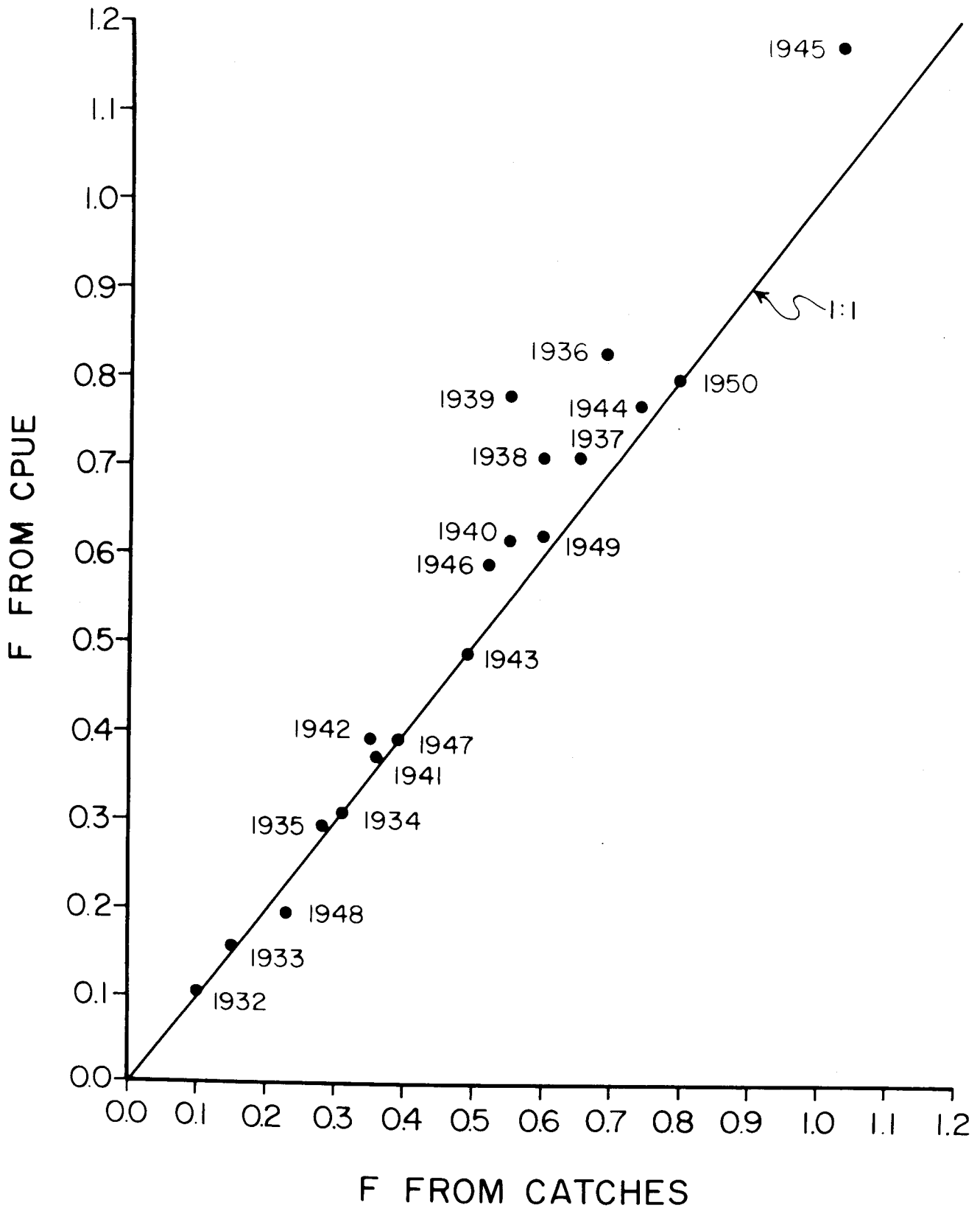

FIGURE 2. Comparison of instantaneous fishing mortality rates for fishing seasons estimated by cohort analysis of sardine CPUE values (Murphy, 1966) and by cohort analysis of catches in numbers.

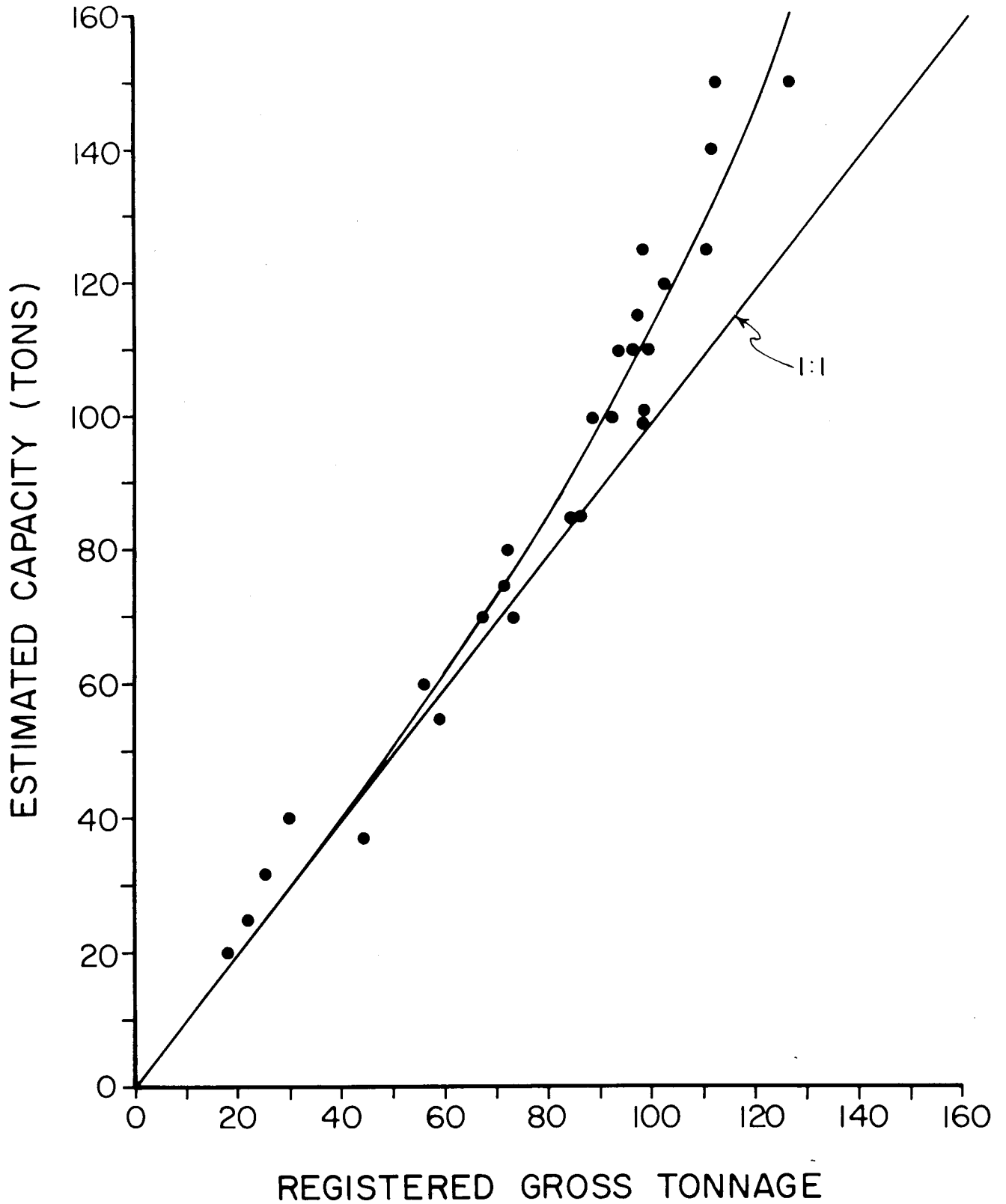

FIGURE 3. Relationship of estimated vessel carrying capacity of sardines to registered gross tonnage.

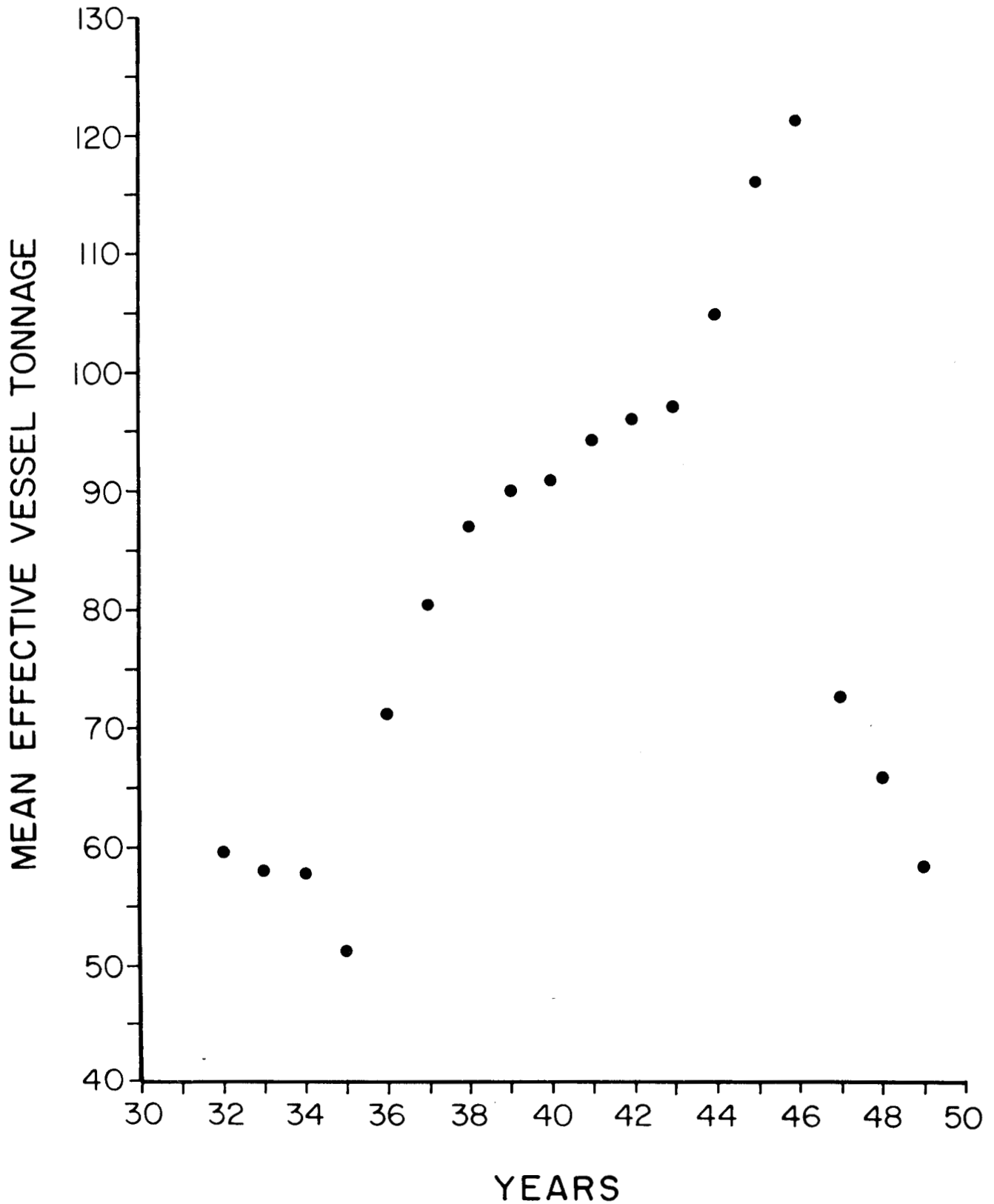

FIGURE 4. Mean effective sardine carrying capacity of vessels.

effort in boat-months by mean boat carrying capacity in tons. For seasons 1946–48, Clark's correction for limits was removed before multiplying by effective mean tonnage. In 1945, Clark's worksheets indicate a correction for limits, but values for the limits themselves are not available. Clark's corrected effort was retained, and was multiplied by unadjusted mean boat tonnage.

The effort points for 1946, 1947, and 1948 are anomalous in that Clark relaxed her effort criteria due to low abundance of sardines, and thus tended to overestimate effort. Daugherty (California Department of Fish and Game, MS) states: "For boats fishing at Monterey or San Francisco, one delivery in a dark was assumed to be evidence that a boat was fishing the whole dark" and "this year [1947–48], also, due to the large amounts of jack mackerel and Pacific mackerel that were caught, deliveries of those fishes were considered along with sardine deliveries in determining whether a boat was fishing at least 2 weeks out of the dark. This resulted in many boats being included which would not otherwise have been, there being a number of cases in which a boat made no sardine deliveries but its mackerel deliveries showed it to be actively fishing." A "dark" is a period of new moon, when fishing, which is done at night, is most actively pursued. Similar changes in criteria hold for 1946–47 and 1948–49. This change in criteria was an attempt to overcome a basic deficiency in the raw effort data: boat activity resulting in no catch went unreported, since the evidence for boat activity was landings receipts. Original criteria were resumed for 1949–50 and 1950–51.

Handbooks on methods for assessing fish stocks (Ricker, 1958; Gulland, 1969) recommend stratifying CPUE by geographic areas and adding the individual CPUE values, weighting each as the size of its sub-area. This method helps account for changes in distribution of the stock which may result from changes in population size. As a simple attempt at stratification, Monterey and San Pedro area CPUE values given by Clark and Daugherty (1952) were treated as separate area strata (Table 3). Areas were obtained from the catch distributions given by Pinkas (1951). Those reporting blocks wherein catch exceeded 100 tons were counted, giving an area of 74 blocks for Monterey and 111 blocks for San Pedro, with Point Conception as the arbitrary dividing line.

**RESULTS**

Recalculated catchability coefficients and mean population sizes (Table 1) were plotted (Figure 5), and an increase in catchability with reduced population size is clearly indicated. Howbeit, there remain problems in interpreting the time series. Data points for the late 1940's are subject to considerable question, as discussed earlier. Observations for 1949 and 1950 could be subject to

influences of the boom in gear development and fish detection methods which was in progress by the early 1950's. The 1945 point must be suspected to be affected by limits on cannery deliveries. The 1946–48 points are based on altered standards for determining effort, and are not comparable with points for other years; yet, judging by the catchability coefficients for those years, Clark's "relaxed" criteria may have led to a better measurement of effort (more constant q) than did her standard criteria.

Catchability coefficients based on the two-area stratified CPUE (Table 3) were plotted against mean population size (Figure 6) for comparison with unstratified CPUE. The two plots are very similar, indicating that this simple stratification does little to

TABLE 3  
Catchability Coefficients for Two-Area Stratified CPUE

Year	Catch per unit effort			Catchability coefficient 10 <sup>-2</sup> /ton-month
	San Pedro	Monterey	Mean* 10 <sup>3</sup> fish/ ton-month	
	10 <sup>6</sup> fish/boat-month			
1932.....	3.53	3.78	6.08	3.57
1933.....	4.88	3.70	7.61	5.34
1934.....	5.59	6.14	10.04	8.19
1935.....	4.21	4.49	8.43	6.33
1936.....	2.97	4.86	5.23	7.36
1937.....	2.20	2.54	2.91	5.29
1938.....	3.42	4.76	4.55	6.69
1939.....	2.56	4.46	3.69	5.11
1940.....	4.05	3.95	4.42	7.07
1941.....	3.42	5.27	4.42	2.85
1942.....	4.52	3.88	4.45	3.82
1943.....	2.58	3.98	3.24	4.48
1944.....	3.70	3.69	3.53	7.06
1945.....	3.33	1.91	2.38	8.94
1946.....	2.19	0.46	1.24	5.45
1947.....	0.96	0.32	0.97	5.11
1948.....	2.11	1.38	2.77	5.44
1949.....	3.75	3.22	6.07	14.15
1950.....	2.38	0.56	3.05	9.30

\* San Pedro weight = 111, Monterey weight = 74.

improve the CPUE index.

Catchability coefficients for the period 1932–1935 are anomalous for both measures of CPUE, with the 1936 value also appearing as an outlier in the unstratified case. There is no definite explanation for this series of anomalous points, however, some possibilities may be suggested. The economic conditions of the early 1930's may have allowed only the most efficient boats to remain operating. Alternatively, the correction for the effect of cannery limits on mean boat carrying capacity may result in underestimated nominal effort, particularly with respect to landings at offshore reduction ships, which were probably unaffected by such limits. Mean uncorrected tonnages for the 1932 through 1936 seasons are 66.15, 66.09, 65.14, 65.57 and 72.53 tons respectively. Division of catchability coefficients by the uncorrected/corrected tonnage ratio results in a slight downward shift of the five points, however, they remain as distinct outliers. A

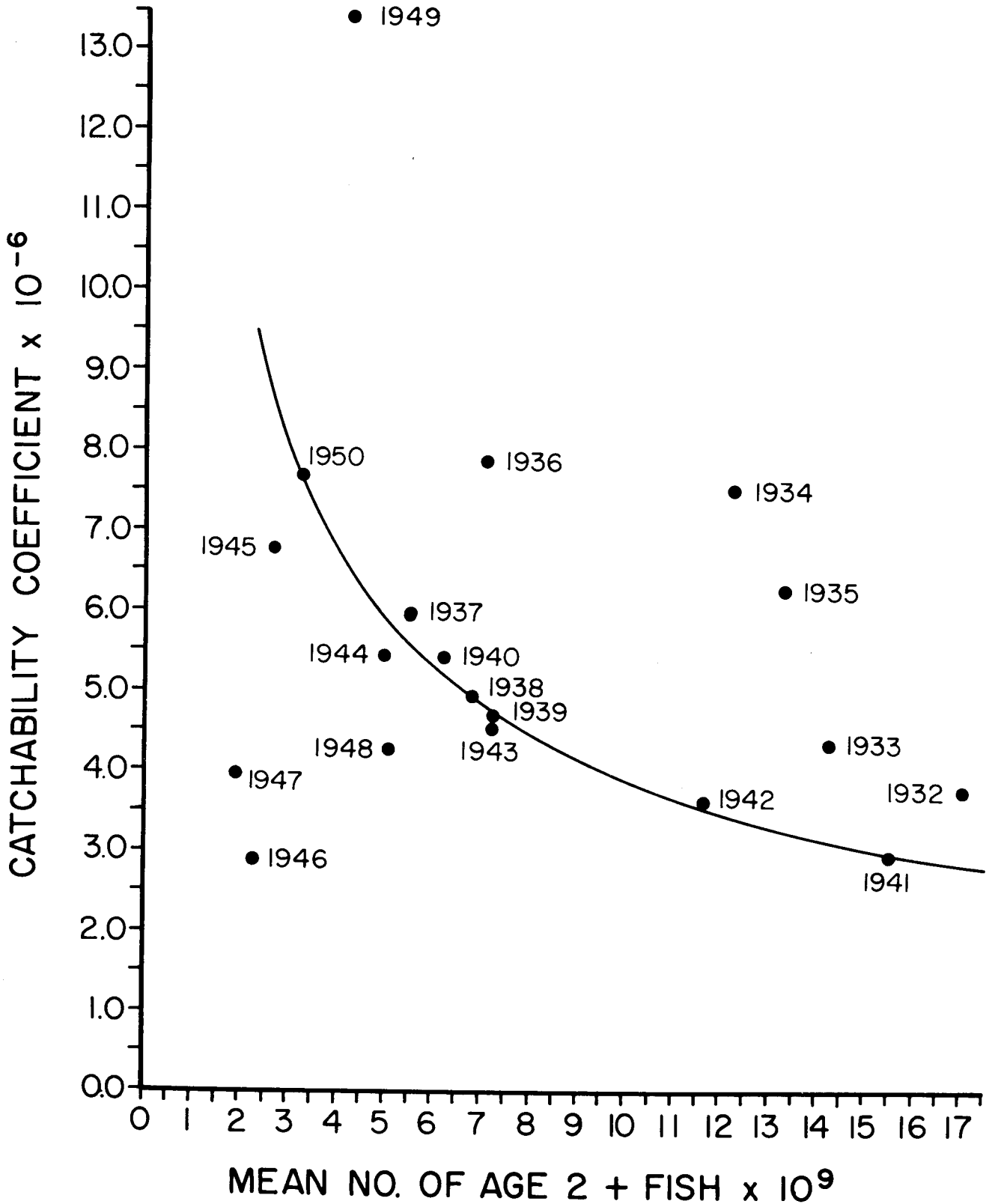

FIGURE 5. The relationship of catchability coefficient to mean population size for unstratified CPUE.

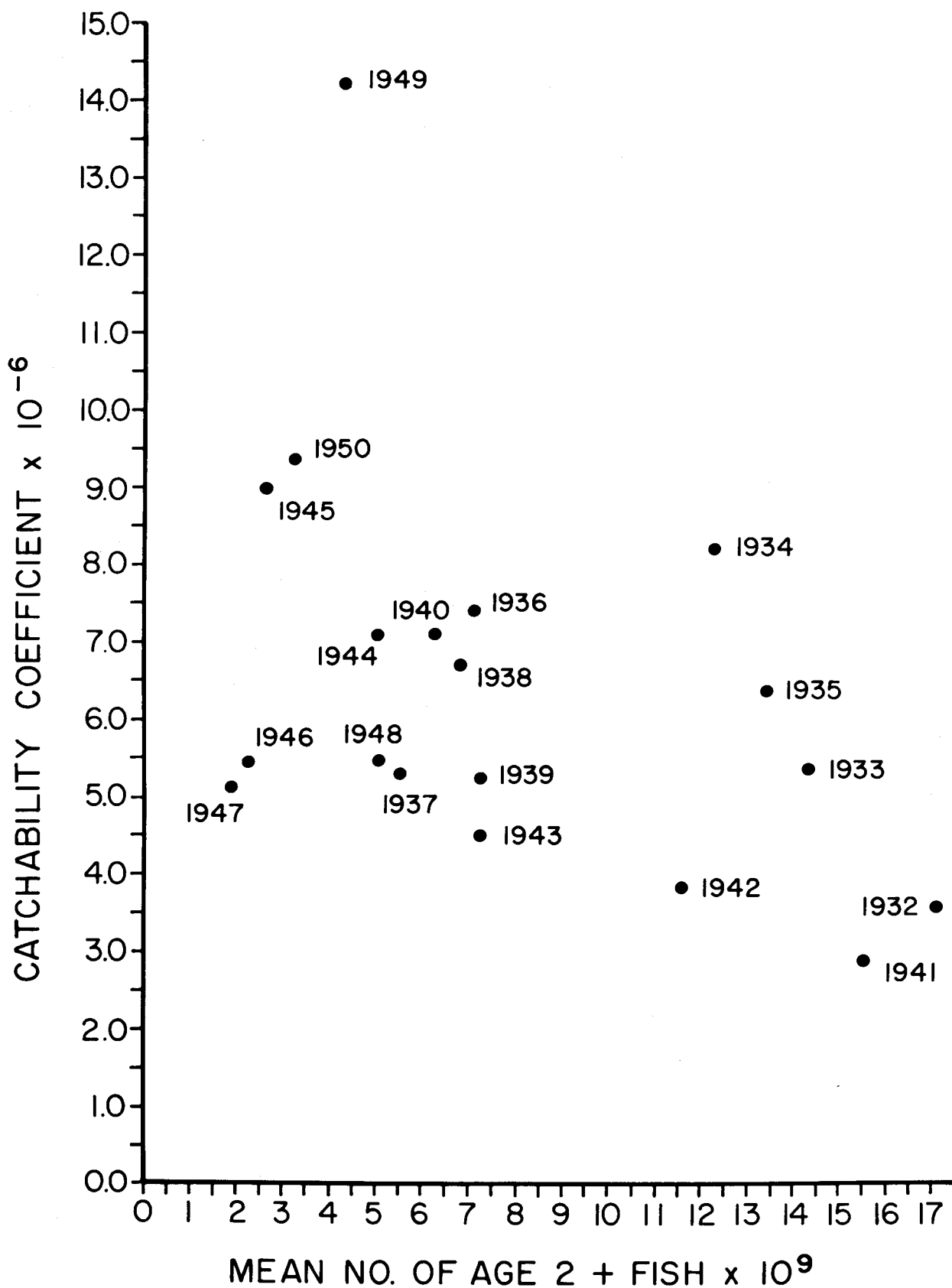

FIGURE 6. The relationship of catchability coefficient to mean population size for two-area stratified CPUE.

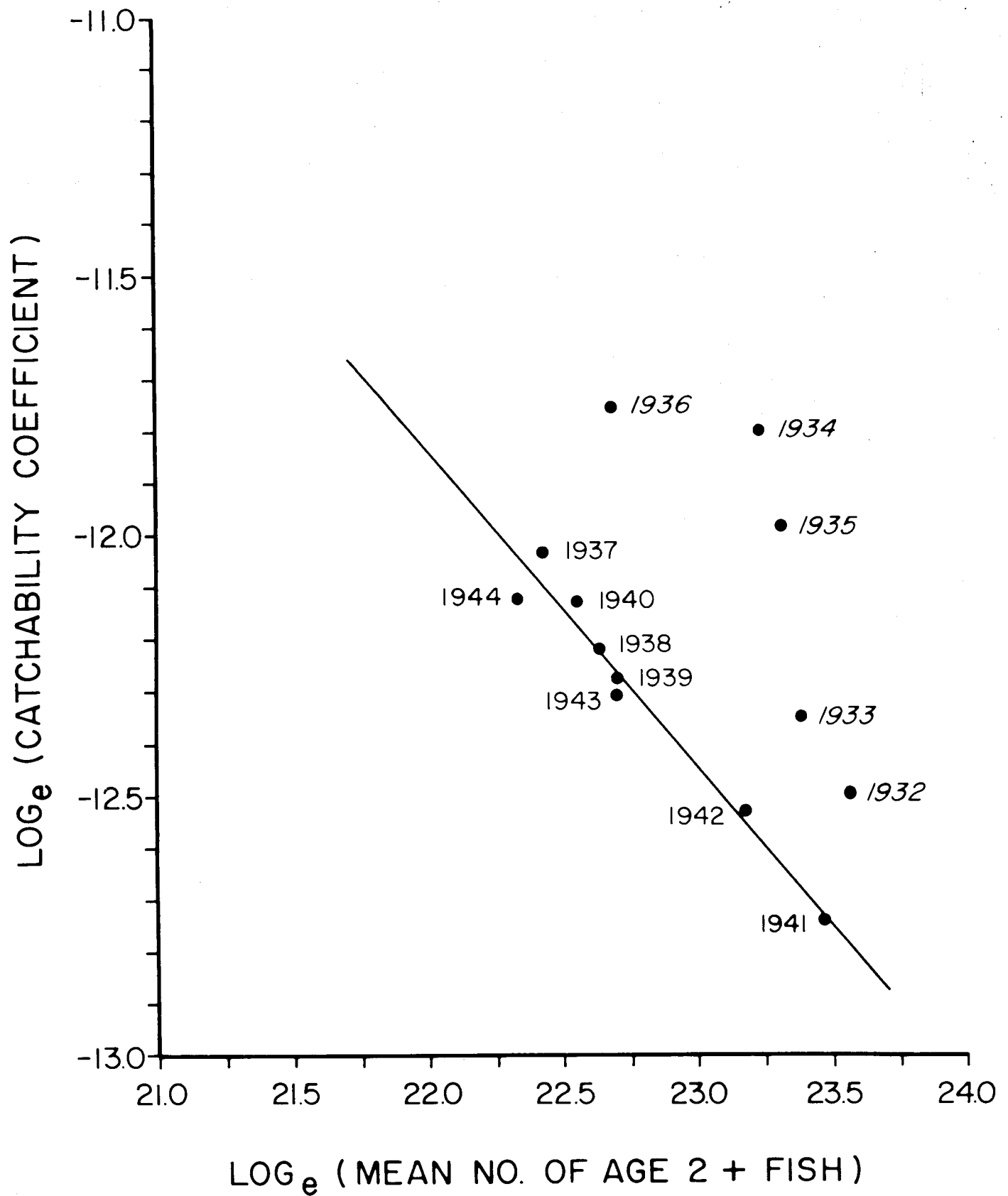

FIGURE 7. Regression of catchability coefficient on mean population size after logarithmic transformations. (Years in italics not included in regression).



likely explanation for these outliers is overestimation of  $F$  and consequent underestimation of mean population size, although this cannot be verified and must remain a hypothesis.

Most other factors would suggest that catchability coefficients should have increased during the 1930s. Scofield (1951) describes several trends in gear development during this period. Radiotelephones were first tried in 1935 and by 1937 were fairly common in San Francisco and San Pedro. During the period 1930 to 1940 ringnets were replacing lampara nets (presumably because the fishermen felt they were more efficient), and the changeover from pulling nets by hand to use of power also was taking place. It is difficult to quantify the effects of these innovations, but the catchability coefficient for the early period is probably dominated by the combined effects of small boat tonnage and cannery limits. Gulland (1964) states ". . . small boats fishing for shoaling fish (e.g., sprats) may catch, in one successful haul, as many fish as they can conveniently carry. The catch per haul or per voyage is likely to be constant over a fair range of stock abundance . . ." suggesting a  $\beta$  value of  $-1$ . While a regression based on five points is of limited value, the  $\beta$  of  $-1.005$  obtained from the 1932-36 unstratified CPUE (Table 2) supports the above contention, although the 1936 season was minimally affected by limits, which appeared only in the fall Monterey fishery.

Processing capacity of canneries increased by the mid-1930's so that limits were no longer necessary. This, combined with an influx of new large vessels from a resumption of boat building, resulted in a freely expanding fishery. In the absence of restrictions (except for fishing season), boats were able to operate at full capacity and the catchability coefficient was determined primarily by biological factors, particularly fish distribution and behavior. Catchability coefficients for the period 1937-44 show a highly significant density dependence ( $F = 130.8^{**}$ ). The value of  $\beta = -0.611$  (stratified case,  $\beta = -0.841$ ) for this period furnishes clear evidence for a density dependent catchability coefficient and nonlinear CPUE. The evidence is strengthened by the fact that population size increased from 1937 to 1941 and subsequently decreased, with catchability coefficients maintaining the relationship over the complete cycle.

After 1944 conditions in the fishery changed, making comparison difficult. Limits of 30 tons per delivery were placed on small fish landed in Monterey. In 1946 and 1947 a lack of fish in central California resulted in a relocation of the fleet to southern California, where further delivery limits were imposed due to lack of sufficient processing facilities. Criteria for defining effort were changed, as described in a previous section. In the late 1940's aerial scouting began to be used in the fishery, and many of the less efficient vessels disappeared from

the fleet, further biasing the apparent catchability coefficient. Analysis of the time series was not attempted for these later seasons.

An "overall" value of  $\beta$  was estimated from the entire time series with the 1946-48 data deleted using a GM regression (Richer, 1973) of log-transformed variables (Table 2). Since the periods 1932-35 and 1937-44 show separate and distinct trends (Figure 7), and values from the late 1940s are of questionable comparability due to changes in gear and methods, the "overall" value of  $\beta = -0.670$  (stratified case,  $\beta = -0.719$ ) may be useful as a general description of the trends in  $q$  over the entire time period, but fails to describe the detailed behavior of the fishery.

## DISCUSSION

The assumption of constant catchability has been widespread in quantitative fisheries analysis, although it has been recognized as a weak point, particularly when CPUE is not stratified by geographic subareas, and when applied to the analysis of CPUE from purse seine fisheries in particular. This study presents further evidence that such a catchability coefficient may be a variable, and that it may be possible to describe its behavior as a function of fish abundance. Moreover, a simple attempt at stratification by large geographic areas yields no improvement in the CPUE index, giving further reason to reject the *a priori* assumption that geographical stratification of CPUE results in a reasonably constant catchability coefficient or valid index of abundance. A simple power function (Equation 1) appears to fit the observations well, has a parameter ( $\beta$ ) of density dependence which is easily determined, has a simple interpretation, and has desirable mathematical properties for incorporation into more complex fisheries models (e.g., Fox, MS). If the power function proves to be a useful model for other fisheries and measures of effort, it may become possible to assume a value for  $\beta$  based on comparable fisheries rather than assume  $\beta = 0$  as is presently done. For example, an assumed  $\beta$  of  $-0.5$  would be equivalent to the assumption that the square of CPUE is a good index of relative abundance.

The assumption of constant catchability coefficient should be seriously considered before applying many of the standard quantitative methods used in fisheries analysis. A range of solutions can be obtained by incorporating maximum and minimum likely values for  $\beta$ ; or the importance of assumptions of value for  $\beta$  can be determined by sensitivity analysis or simulation. Determination of natural mortality rate by regression of total mortality rate on effort is affected by changes in catchability coefficient (Garrod, 1964). The DeLury or Leslie method can be seriously affected by changes in  $q$  (Braaten, 1969). Fox (National Marine Fisheries

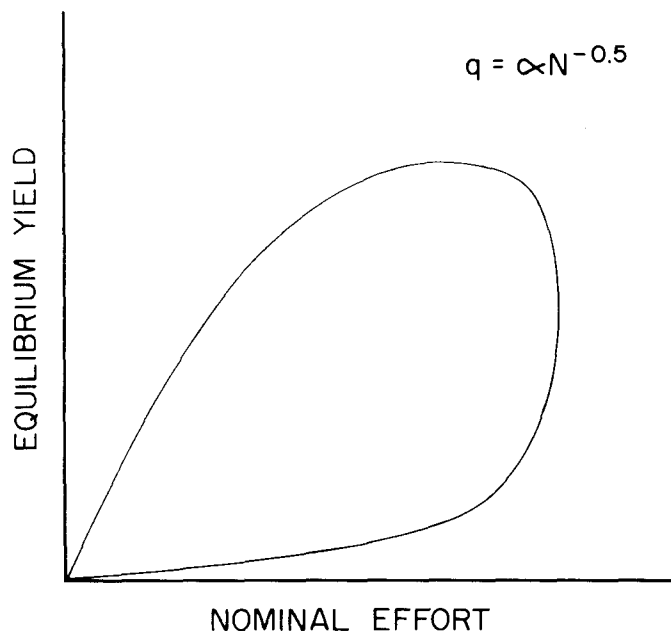

FIGURE 8. Production model behavior when  $\beta = -0.5$  (after Fox, 1974 MS).

Service, MS) has shown that the shapes of equilibrium yield curves obtained from surplus production models are profoundly affected by values of  $\beta$  (Figure 8). As  $\beta$  approaches a value of  $-1$ , the level of nominal effort necessary to achieve maximum sustained yield approaches a critical point at which the fishery collapses, as seems to have happened in the case of the Pacific sardine. Unfortunately, production model estimation of  $\beta$  is difficult if effort has never approached the critical level.

The effectiveness of some forms of fishery management may be affected by violation of the assumption of a constant catchability coefficient. Pope and Garrod (1975) examine some of the implications of variable catchability coefficients on catch quotas and effort quotas for fishery management. Validity of limited entry or control of effort as a management tool is often based on the assumption of non-negative  $\beta$ . When  $\beta = 0$ , a unit of effort will generate a proportional rate of fishing mortality independently of population size. With  $\beta > 0$ , a unit of effort will generate a decreasing rate of fishing mortality as abundance decreases and limited entry may lead to an ideal buffering against overexploitation. On the other hand, when  $\beta < 0$ , a condition of instability results, due to fishing mortality becoming more intense as population declines (Radovich, 1973). In such a case, maximum nominal fishing effort must be kept below the critical level and a better measure of effort must be found, or inefficiencies must be imposed on fishing. Most management regulations applied to open fisheries,

such as catch quotas, gear restrictions, fishing seasons, and area closures fall under this latter category.

#### ACKNOWLEDGEMENTS

I wish to thank Gary Stauffer, Herb Frey, and Kate Coleman for their help.

#### REFERENCES

- Braaten, D. O. 1969. Robustness of the DeLury population estimator. Canada, Fish. Res. Bd., J., 26: 339-355.
- Clark, F. N. 1939. Measures of the abundance of the sardine, *Sardinops caerulea*, in California waters. Calif. Div. Fish and Game, Fish. Bull., (53): 1-45.
- Clark, F. N., and A. E. Daugherty. 1952. Average lunar month catch by California sardine fishermen, 1949-50 and 1950-51. Calif. Fish and Game, Fish. Bull., 38(1): 85-97.
- Garrod, D. J. 1964. Effective fishing effort and the catchability coefficient  $q$ . Rapp. Cons. Explor. Mer., 155: 66-70.
- Gulland, J. A. 1964. Catch per unit effort as a measure of abundance. Rapp. Cons. Explor. Mer., 155: 8-14.
- \_\_\_\_\_. 1969. Manual of methods for fish stock assessment. Part 1. Fish population analysis. FAO, Manuals Fish. Sci. 4, 154 p.
- Knaggs, E. H. 1972. San Pedro wetfish fleets: Major purse-seine gear changes, 1952-72. Commer. Fish. Rev., 34(5): 11-32.
- Marr, J. C. 1950. Apparent abundance of the pilchard (*Sardinops caerulea*) off Oregon and Washington, 1935-43, as measured by the catch per boat. U.S. Fish. Wildl. Serv., Fish. Bull., 51(52): 385-394.
- Murphy, G. I. 1966. Population biology of the Pacific sardine (*Sardinops caerulea*). Proc. Calif. Acad. Sci., 4th Ser., 34: 1-84.
- Ostvedt, O. J. 1964. Comparison between catch per unit effort in the Norwegian gill-net and purse-seine fishery for herring. Rapp. Cons. Explor. Mer., 155: 90-93.
- Paloheimo, J. E., and L. M. Dickie. 1964. Abundance and fishing success. Rapp. Cons. Explor. Mer., 155: 152-163.
- Pinkas, L. 1951. Yield per area of the California sardine fishing grounds, 1937-1949. Calif. Dept. Fish and Game, Fish. Bull., (80): 9-14.
- Pope, J. G., and D. J. Garrod. 1975. Sources of error in catch and effort quota regulations with particular reference to variations in the catchability coefficient. ICNAF Res. Bull., 11: 17-30.
- Radovich, J. 1973. A challenge of accepted concepts involving catch per unit of effort data. Proc. Annu. Meet. Calif.-Nevada Chapter Am. Fish. Soc., Feb. 3, 1973, 6 p.
- Ricker, W. E. 1958. Handbook of computations for biological statistics of fish populations. Canada, Fish. Res. Bd. Bull., (119): 1-300.
- \_\_\_\_\_. 1973. Linear regressions in fishery research. Canada, Fish. Res. Bd. J., 30: 409-434.
- \_\_\_\_\_. 1975. Computation and interpretation of biological statistics of fish populations. Bull. Fish. Res. Board Can., 191: 1-382.
- Schaaf, W. E., and G. R. Huntsman. 1972. Effects of fishing on the Atlantic menhaden stock: 1955-1969. Trans. Am. Fish. Soc., 101: 290-297.
- Scofield, W. L. 1951. Purse seines and other roundhaul nets in California. Calif. Dept. Fish and Game, Fish. Bull., (81): 1-83.
- Tomlinson, P. K. 1970. A generalization of the Murphy catch equation. Canada, Fish Res. Bd., J., 27: 821-825.

# SONAR MAPPING IN THE CALIFORNIA CURRENT AREA: A REVIEW OF RECENT DEVELOPMENTS

ROGER HEWITT

National Oceanic and Atmospheric Administration  
National Marine Fisheries Service  
Southwest Fisheries Center  
La Jolla, California 92038

## ABSTRACT

Some developments in the use of sonar to study pelagic fish schools are reviewed. Techniques for counting the number of fish schools per unit area, measuring their horizontal dimensions, determining their biomass, sizing individual fish within a school, and distinguishing northern anchovy, *Engraulis mordax*, schools from all others are discussed briefly. Acoustic observations of the distribution, behavior, sizes, and packing density of anchovy schools are reviewed.

## INTRODUCTION

It is the intent of this paper to review the use of horizontally directed echo ranging devices (sonar) to study pelagic fish schools off the coast of California. Research objectives are reviewed and several papers by biologists at the California Department of Fish and Game (CDFG) and the Southwest Fisheries Center (SWFC) are discussed as they relate to a development of sonar research.

Sonar mapping is the process by which a sample transect of the upper mixed layer of the ocean is insonified by a ship proceeding at 9 to 12 knots. Echo

returns are recorded or digitized for detection of aggregations of organisms thought to be mostly fish shoals. The primary measurements are the location of each school in the horizontal plane and the diameter of the school on an axis perpendicular to the direction of travel of the survey vessel (Figure 1). The method was first discussed by Smith (1970) and later by Mais (1974) and Hewitt, Smith and Brown (1976). Collectively the measurements yield the number of fish schools per unit area, the geographical distribution of fish schools within the survey area, and the relative proportions of the fish school sizes.

Other measurements of the acoustic return have been demonstrated to be of use in estimating the biomass of a school, the size of the fish in a school, and in identifying schools of the northern anchovy, *Engraulis mordax*, in a mixture of fish schools. Unfortunately these measurements have not yet been feasible from a ship underway at full speed.

## RESEARCH STRATEGY

The ultimate intention of the program to detect and determine fish schools by sonar is to develop a tool for pelagic fish stock assessment and to describe its precision. A secondary goal is to investigate the nonrandomness (or patchiness) of the spatial distribution of fish schools, particularly its similarity to distributions encountered when studying other life stages of the same group of animals; e.g., pelagic fish eggs and fish larvae.

In 1968, with these goals in mind, the development of the following capabilities were established as objectives of the research program:

- 1) To count the number of fish schools per unit of sea area,
- 2) To measure the horizontal dimensions of detected fish schools,
- 3) To estimate the fish biomass of any detected school,
- 4) to estimate the size of individuals constituting a school,
- 5) To distinguish northern anchovy schools from all other aggregations.

Progress toward the accomplishment of these objectives may be most clearly described with the use of a simple matrix which considers the five objectives, in terms of measurement capabilities, and

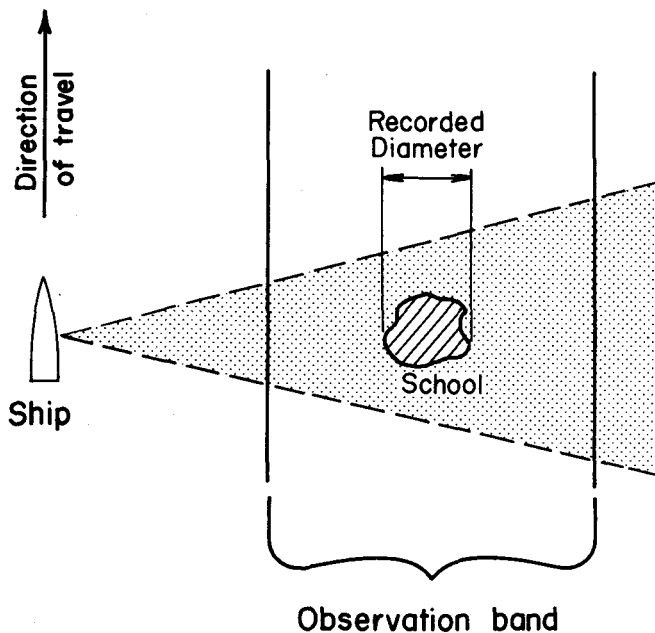

FIGURE 1. Plan view of the sonar mapping technique. Transducer is fixed at 90° to the ship's head rather than swept from side to side as in searching patterns.

the degree to which these capabilities may be considered practical operations (Table 1).

**TABLE 1**  
**Objectives of the Research at the Southwest Fisheries Center and the Degree to Which These Objectives have been Attained, as of 1975.**

Objective	Phase I develop theory/ technique	Phase II demonstrate/ test feasibility	Phase III practical operation from a ship underway at 9-12 knots
1. Count fish schools per unit area	Accomplished	Accomplished	Automated and corrected for known biases
2. Measure horizontal school dimensions	Accomplished	Accomplished	Automated and corrected for known biases
3. Determine school biomass	Accomplished	Direct methods shown to be feasible indirect methods currently being calibrated	
4. Determine individual fish size	Accomplished	Acoustic techniques demonstrated as feasible	
5. Distinguish northern anchovy	Accomplished	Acoustic techniques demonstrated as feasible	

**Counting Fish Schools and Measuring Their Horizontal Dimensions**

The technique for determining the number of fish schools per unit area and their horizontal dimensions has been developed into a practical method and automated with a shipboard computer. All known biases have been investigated and proper corrections applied to the technique (Hewitt, Smith, and Brown, 1976).

A significant source of potential bias, encountered when enumerating schools with sonar, is the variation in effective range caused by internal waves. Temperature and salinity variations, due to internal waves, cause changes in the magnitude of sound velocity. While investigating the expected tidal period of these waves, Smith (1973) noted that variations of equal amplitudes occurred with periods as short as 5 minutes. The implication of short range spatial variations and the infeasibility of collecting coherent sound velocity profiles, led Smith to suggest a statistical approach to the estimation of a probable effective range.

Smith assembled long term hydrographic data for several subregions of the California Current area by month. He then assumed that no fewer than two sound velocity profiles per month-region stratum would be taken and sampling activities were allocated among regions and seasons to reduce the

standard error of the mean sound velocity gradient to a uniform value. To illustrate the idea, a portion of his "allocation" table is reproduced here (Table 2).

**TABLE 2**  
**An Allocation of Sound Velocity Profiles Among Inshore Areas (0-80 miles from coast) by three regions and 4 months.**

	Southern California inshore	Northern Baja California	Southern Baja California
January.....	2*	2*	3*
April.....	6	4	5
July.....	25	14	36
October.....	23	11	17

\* The numbers indicate the number of profiles necessary to equalize the standard error of the mean sound velocity gradient in the upper 30 m.

Table 2 describes the number of sound velocity profiles required to equalize the standard error of the sound velocity gradient among regions and months. It may also be used to determine the optimum time of the year to conduct a sonar mapping survey in a particular region in terms of reducing the variability in effective range caused by thermal changes.

Smith further proposed the construction of a probability diagram to apply corrections to the numbers of targets received at various ranges and depths (Figure 2).

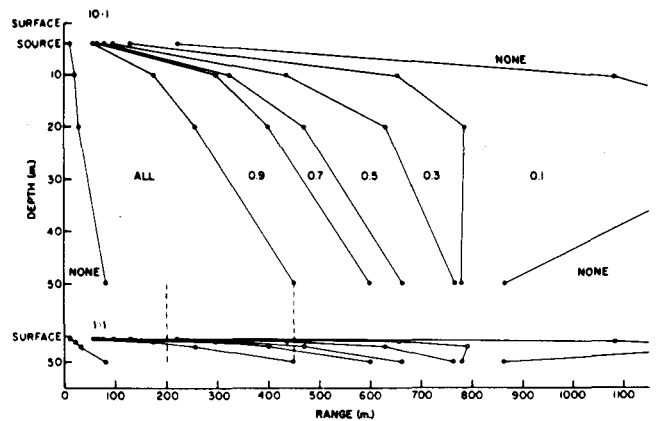

FIGURE 2. A pooled summary of 38 ray trace analyses of limiting range by depth by the probability of detection of -30 db targets (from Smith, 1973). Sound velocity profiles were obtained in October 1972 off the southern California coast.

Mais (1974) discussed, in some detail, his observations from enumerating and measuring fish schools, particularly those composed of northern anchovy. Mais reports the bulk of detected anchovy schools within 50 nautical miles of the coast and the most seaward school ever detected at 165 miles from shore. The north-south range is characterized by an ill-defined limit in northern California to a more abrupt southern limit 100 miles north of the southern tip of Baja California, with the bulk of detected schools off southern California and northern Baja California.

TABLE 3

Summary of Mais' (1974) Observations on Anchovy Schools and Their Constituents by Three Geographic Regions.

	Northern and central California	Southern California and northern Baja California	Central and southern Baja California
Distribution.....	5% of all detected schools. Bulk of schools within 0.5 miles of shore.	70% of all detected schools. Bulk of schools within 85 miles of shore; largest concentrations within 20 miles of shore.	25% of all detected schools. Bulk of schools within 15 miles of shore.
School types* encountered	I—most common, all seasons III—rare	I—most common, all seasons. II—encountered most frequently in the northern inshore portion of the bight, in the fall. III—encountered most frequently in the southern portion of the bight, in the spring. IV—rare. V—encountered year round in the inshore flats between Santa Barbara and Ventura. VI—encountered rarely in the late summer and fall in the inshore flats between Santa Barbara and Ventura. VII—encountered in the summer.	I—most common, all seasons. V—prevalent school type encountered in the summer and fall. III—encountered in the northern portion of region in the spring.
Age and length.....	Largest fish—most rapid growth	Slightly smaller fish than north and central California. Moderate growth—larger fish offshore, smaller inshore.	Slowest growth—shortest lived least maximum length.

\* See text for explanation of school types.

Mais (1974) also reported a mean vertical school dimension of 12 m and both Mais and Hewitt et al. (1976) reported a median horizontal school diameter of 30 m. Mais further identified and described seven school patterns observed for the northern anchovy. The school types are briefly described below and summarized by region and occurrence (Table 3).

*Type I:* The most common school type encountered was 5 to 30 m diameter, 4 to 15 m thick (vertical dimension) and 9 to 18 m from the surface. These schools were the dominant type year-round but were detected most frequently during late winter and early spring. The schools were well delineated during the day, dispersing into a thin scattering layer at dusk. This was the only school type found to contain actively spawning fish. These schools were usually wary and difficult to approach.

*Type II:* Large schools measuring 25 to 100 m in diameter, 12 to 40 m thick, and 0 to 55 m from the surface were encountered fall through winter over deep water basins and channels adjacent to the coast. These schools dispersed into a coarse scattering layer at dusk and reformed into distinct schools after midnight attaining their densest structures slightly before dawn. Time of schooling reformation occurred progressively later until January or February when it occurred after dawn. These schools were not wary and easy to approach.

*Type III:* Moderately large and dense schools, highly visible at the surface, and measuring 10 to 100 m in diameter and 12 to 40 m thick were encountered during spring and early summer over basins and channels within 20 miles of the coast. Samples from these schools suggested that the fish were in a postspawning stage.

*Type IV:* Large and dense schools were infrequently encountered at depths of 120 to 220 m along canyons and excarpments within 5 miles of the coast. These schools were observed to rise to the surface at dusk and form a heavy scattering layer. After midnight, surface schools would reform and submerge to daytime depths at dawn.

*Type V:* A loose and extensive scattering layer was occasionally observed during all seasons in the shallow flats (<100m) between Santa Barbara and Ventura, California, and in the summer and fall off central Baja California. The scatter was near bottom during daylight hours and formed a thin surface layer at night.

*Type VI:* Infrequently dense schools were observed in the shallow flats between Santa Barbara and Ventura during the summer and fall. These schools would form a scattering layer at dusk and regroup after midnight.

*Type VII:* A loose and extensive scattering layer was occasionally observed offshore of southern California during the

summer months. Such concentrations were observed during daylight hours and over deep water.

### Estimating Biomass

The determination of fish biomass contained in a school cannot at present be considered a practical operation; however, some progress has been made toward developing this capability. Anchovy school biomass is assumed to be a function of schooling densities. A theoretical model of school compaction has been developed to describe the maximum variability one may expect in school densities; two direct methods of sampling school compaction have been employed; and work is continuing with the aim of correlating direct and indirect measures of school compaction.

To gain an idea of school structure and resulting densities, an idealized model may be employed which can be used to compute the space required for a single fish when separated from its neighbors by a specified distance. The inverse of the resulting volume yields the number of fish which may occupy a unit volume for a given interfish spacing.

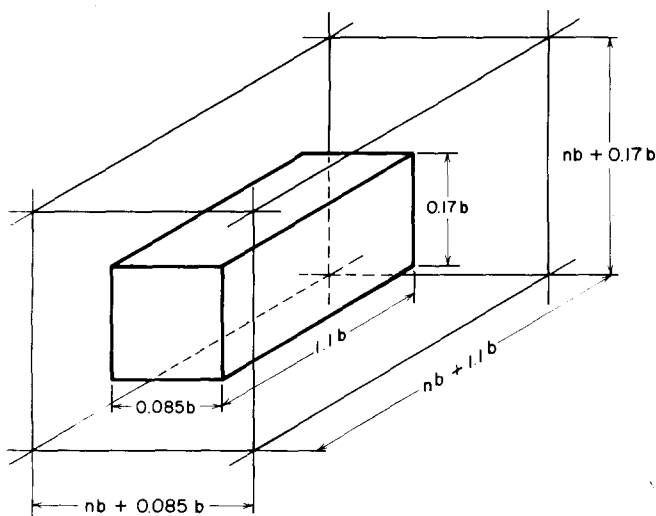

FIGURE 3. Idealized volume required by a single fish of standard length  $b$  in a school whose packing density is expressed by an interfish distance of  $nb$ .

The standard length,  $b$ , of an anchovy is used as the basic measurement. The fish is idealized as a rectangular solid whose dimensions are fractions of  $b$ . School structure is idealized by assuming that the fish's six nearest neighbors lie equidistant from the centers of the rectangle's six faces. If the interfish spacing is specified as some multiple of body length,  $nb$ , then the required volume for a single fish may be described (Figure 3). The volume,  $V_n$ , may be expressed:

$$V_n = (nb + 0.085b)(nb + 1.1b)(nb + 0.17b) \\ = (nb)^3 + 1.355n^2b^3 + 0.2950nb^3 + 0.0159b^3$$

School density,  $D_n$ , is the number of fish which may

occupy a unit volume for an interfish spacing of  $nb$ .  $D_n$  may be expressed:

$$D_n = (V_n)^{-1}$$

Using a standard length of 12 cm as typical of anchovy school constituents detected by sonar (Mais, 1974), a range of school densities may be calculated. The minimum spacing which may be attained without interference from the tail beat of adjacent fish is assumed to be  $0.2b$ . The maximum spacing observed to be necessary to retain school integrity under ideal conditions is  $10b$ . Densities have been determined using these maximum and minimum values and three intermediate points (Table 4). A maximum variation in anchovy school compaction of approximately 8,000 fold was estimated using this approach. While the model may be an oversimplification of school structure, it does provide an estimate of the scale of the parameter we are trying to measure.

TABLE 4  
Interfish Spacing and Corresponding School Densities  
as Calculated from an Idealized Model

Interfish spacing in body lengths ( $nb$ )	Density fish (meter) <sup>-3</sup> ( $D_n$ )
10	0.51
7	1.41
4	6.66
1	217.08
0.2	4,219.40

Graves (1974) analyzed *in situ* photographs of anchovy schools in order to estimate various schooling parameters, including school density. Three-dimensional analysis of 10 photographs yielded school densities ranging from 50 to 366 fish/m<sup>3</sup>. Although this represents only a small portion of the possible range of anchovy school compaction, Graves estimates that the technique may be useful over a range of 1,000 fold, i.e., 0.5 to 500 fish/m<sup>3</sup> (pers. comm.).

Another direct method of sampling school compaction was reported by Hewitt, Smith, and Brown (1976). Horizontal dimensions of 49 anchovy schools were measured acoustically and subsequently captured by commercial purse seiners. Assuming the school vertical dimension to be constant, a horizontal school area to biomass conversion factor was calculated by dividing the weight of the school by its detected area. Hewitt, Smith, and Brown (1976) used the mean of a distribution of this factor (Figure 4) to convert detected horizontal school area to fish biomass on a sonar mapping survey of the Los Angeles Bight. Assuming a vertical school dimension of 12 m and an individual fish weight of 20 g, these factors may be converted to school densities with a range of 0.52 to 533 fish/m<sup>3</sup>.

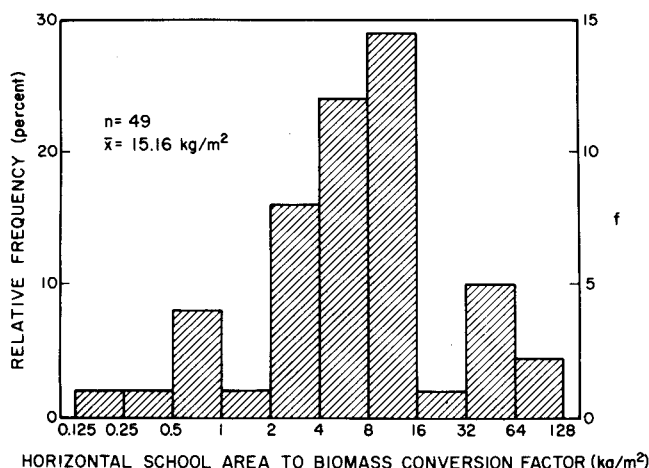

FIGURE 4. Distribution of horizontal school area to biomass conversion factors obtained from the charter boat experiment (from Hewitt, Smith, and Brown, in press).

The ideal method would be to correlate an indirect school measurement, in this case an acoustic parameter, with direct estimates of school compaction and thus establish a remote sensing technique for determining school density. Target strength, the ability of an object to reflect a sound wave, is an acoustic parameter easily measured with proper system calibration and signal digitizing equipment. When recording a peak value of target strength for each school, Hewitt, Smith, and Brown (1976) were able to describe a distribution range of 30 db (1,000 fold).

There are, however, several problems to consider when attempting to relate school target strength with school density. The target strength of a single fish has been shown to vary considerably with aspect by several experimenters (Cushing, 1973). One may expect this condition to exist in an aggregation of fish sharing a common directivity. Secondly, a fish school is neither a solid object nor a point source as considered in classical acoustic theory. Attenuation or absorption of the sound wave in a school must be considered as a complex function of fish aspect, reflection between fish and school density. Lastly, since target strength is measured by sampling a continuous variable (echo power), the calculation of a single value for each school is a function of the sampling frequency and averaging method employed.

Work is ongoing, at the SWFC, with the aim of correlating direct measures of fish school compaction (using camera and capture methods) with indirect measures (target strength). Schools are being insonified from several directions in an attempt to detect school aspect dependence of target strength estimates. Target strength estimates are being made, using a variety of methods, from echoes which have been digitized at the smallest significant interval. The resulting distributions will be

compared in a search to find the most meaningful one. The strategy is not to attempt to describe the interaction of a sound wave and an aggregation of fish, but to define an acoustic measurement, if any, which most accurately represents the school.

#### *Sizing Individual Fish; Distinguishing Northern Anchovy*

Holliday (1972, 1973, 1974) approached these related problems from an acoustician's point of view and demonstrated to biologists that meaningful information may be obtained by the application of acoustic theory. He investigated the frequency domain of echoes from pelagic fish schools by examining the resonance structure of echo returns (1972), and by studying the Doppler spread in echo energy (1974).

Using broad-band explosive acoustic sources and narrow-band spectral analysis, Holliday (1972) observed significant resonant structure in five schools. The schools were subsequently sampled and theoretical predictions for the resonant swim bladder response compared with the experimentally observed resonances. Correlation was made (Figure 5), and a method established for remotely determining the presence of swim bladders in an aggregation of pelagic organisms. A relationship between fish size and resonance frequency also was demonstrated. Holliday further suggested that the technique may be used for acoustic determination of weight or length distributions within a species and age determinations within a population.

The resonant frequency technique was modified and extended to underway operation at ship speeds up to 5 knots and described by Holliday in 1973. A towed arcer source, similar to those used for seismic profiling, and a towed hydrophone array were employed to detect significant frequency structure

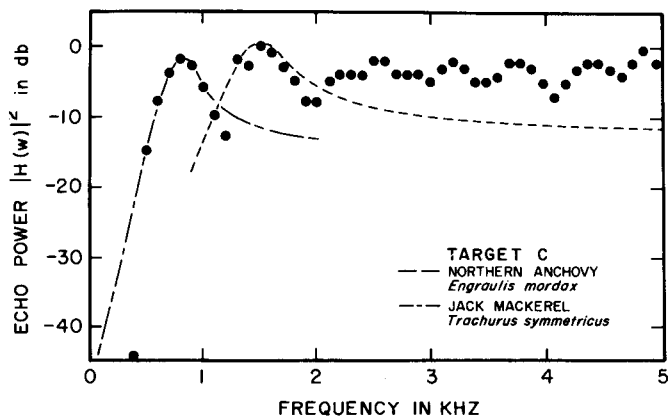

FIGURE 5. An example of the comparison between predicted and observed frequency structure in four echoes from a mixed school of jack mackerel and northern anchovy. The dashed lines represent predicted swim bladder resonance response and the dots represent observed values. The difference between the predicted curve and experimental points above 2 kHz is attributed to scattering from scales, bones, and flesh (Holiday, 1972).

in fish school echo returns (Figure 6). The structure was explained by resonant scattering from fish swim bladders.

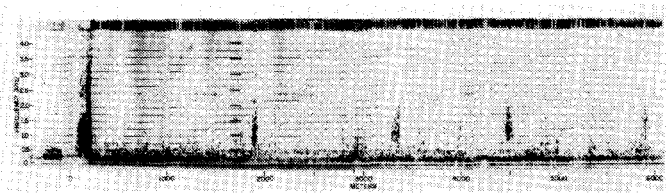

FIGURE 6. Frequency structure in fish schools echoes obtained from an underway survey vessel. Distance along the survey track is displayed on the abscissa; frequency is displayed on the ordinate; and echo energy is displayed as marking intensity (light marks representing less energy than dark marks).

In 1974, Holliday published a study of Doppler energy spread detected in echoes from pelagic fish schools. From the Doppler shift of side aspect echoes, the tail beat velocities of school constituents were calculated. Using Bainbridge's (1960) equation relating swimming speed, length, tail beat amplitude, and tail beat frequency, Holliday calculated the corresponding body lengths. These lengths agreed well with average fish lengths computed from observed school cruising speeds. When examining the Doppler spread from head and tail aspect echoes, Holliday was able to detect swimming behavior characteristics, particularly the accelerate-and-glide swimming behavior associated with northern anchovy and jack mackerel. By knowing the individual fish length and swimming behavior, it may be possible to distinguish northern anchovy from other common pelagic schooling organisms in the California Current area.

The two techniques described above are potentially valuable tools to the fisheries biologist. Additional work must be performed before they can be considered fully developed. In the case of resonance structure, information on the acoustical and physical properties of gas filled swim bladders as a function of depth, season, and geographic location

must be obtained. With regard to Doppler structure, additional experimentation and confirmation of results is necessary.

Visual species identification is also possible by examining photographs taken with a free-fall camera\* described by Graves (1974). The camera and method for quantifying photographs of fish obtained with it are valuable tools for confirming and calibrating remote sensing techniques.

## ACKNOWLEDGMENTS

I would like to acknowledge the help of John Graves, David Kramer, Reuben Lasker, David Mackett, and Paul Smith for assembling and editing this review.

## REFERENCES

- Bainbridge, R. 1960. Speed and stamina in three fish. *J. Exp. Biol.*, 37(1): 129-253.
- Cushing, D. H. 1973. *The detection of fish*. Pergamon Press, 180 p.
- Graves, J. 1974. Three dimensional spacing in pelagic fish schools determined by photography. *Nat. Mar. Fish. Serv., SW Fish. Center, Admin. Rept., LJ-74-44: 1-9.*
- Hewitt, R. P., P. E. Smith and J. C. Brown. 1976. The development and use of sonar mapping for pelagic stock assessment in the California Current area. *Fish. Bull.*, 74(2): 281-300.
- Holliday, D. V. 1972. Resonance structure in echoes from schooled pelagic fish. *J. Acoust. Soc. Am.*, 51(4): 1322-1332.
- \_\_\_\_\_. 1973. Underway measurements of swim bladder resonance in pelagic fish schools. TRACOR, Document No. T-73-SD-1022(u): 1-16.
- \_\_\_\_\_. 1974. Doppler structure in echoes from schools of pelagic fish. *J. Acoust. Soc. Am.*, 55(6): 1313-1322.
- Mais, K. F. 1974. Pelagic fish surveys in the California Current. *Calif. Dept. Fish and Game, Fish. Bull.*, (162): 1-79.
- Smith, P. E. 1970. The horizontal dimensions and abundance of fish schools in the upper mixed layer as measured by sonar, pp. 563-600. *In Proc. Int. Symp. Biol. Sound Scattering in the Ocean.*
- \_\_\_\_\_. 1973. The effects of internal waves on fish school mapping. *ICES-ICNAF-FAO Symp. Acoustic Methods Fish. Res.*, Bergen, Norway 8, 13 p.

\* The camera system, commonly called the Isaac-Brown free-fall camera, was designed and built by John Isaacs and Daniel Brown at Scripps Institution of Oceanography.



# CALIFORNIA UNDERCURRENT IN THE SOUTHERN CALIFORNIA BIGHT

MIZUKI TSUCHIYA

Institute of Marine Resources  
Scripps Institution of Oceanography  
University of California, San Diego  
La Jolla, California 92093

## ABSTRACT

In September 1974 hydrographic measurements were made to study the California undercurrent in the Southern California Bight. Three sections, extending 10 to 15 miles offshore from Del Mar, Oceanside, and Dana Point, were occupied with closely spaced STD stations. The observed distributions of properties suggested that an undercurrent (100–400 m) with a width of only a few miles was present at 5 to 10 miles from the shore.

## INTRODUCTION

The California undercurrent, sometimes called the California countercurrent, is a narrow northward flow that is present below about 200 m and that extends along the coast from Baja California to Cape Mendocino (40°N) or farther north (Reid, Roden and Wyllie, 1958). Water transported by this current is of equatorial origin and characterized by high temperature, high salinity, low oxygen, and high nutrients as compared to California Current water farther offshore. On the temperature-salinity diagram undercurrent water is indicated by a high-salinity bulge centered near 150 cl/t of thermosteric anomaly (Wooster and Jones, 1970). Therefore, the distribution of the California undercurrent can be studied by mapping salinity on the 150 cl/t isanosteric surface. The 150 cl/t surface is 250–300 m deep and probably close to the core depth of the undercurrent. The area of the undercurrent indicated by high salinity (above 34.3‰) on this surface varies considerably from cruise to cruise (Wooster and Jones, 1970). Nevertheless, south of about 29°N (slightly north of Punta Eugenia) it has generally a large offshore extent (>200 miles) and is characterized by a distinct vertical maximum of salinity centered at about the depth of this isanosteric surface. North of 29°N the area of high salinity is limited to a very narrow strip next to the coast, and the vertical distribution of salinity does not exhibit a well defined maximum. (A similar distribution can be seen on the maps of the monthly mean salinity at 150 m prepared by Wyllie and Lynn, 1971.) Subsurface drogoue measurements made by Reid (1963) off northern Baja California also indicate that the northward flow is narrow and found only within about 50 km of the coast. Because of the narrowness of the feature, it can easily escape from the network of the routine CalCOFI observations.

Recently, Wooster and Jones (1970) studied the undercurrent off Punta Colnett (31°N) with an array of closely spaced stations. Their measurements indicate that the northward undercurrent is only 20 km wide and bound to the continental slope.

## STUDY AREA AND METHODS

In September 1974 the northward extension of this flow into the Southern California Bight, where the bottom topography is more complex, was investigated from the E. B. SCRIPPS during her first Southern California Bight study cruise (SCBS-1). Three sections, 20 miles apart, were occupied off Del Mar, Oceanside, and Dana Point (Figure 1). The station intervals were about 1 mile over the steep bottom slope from 100 m to 600 m and 3 to 4 miles in deep water farther offshore. On each station an STD was lowered nearly to the bottom. On seven stations oxygen samples were collected from Nansen bottles attached to the STD cable. No effort was made to directly observe the current velocity.

## RESULTS

Property curves are plotted for two stations (Figure 2). Station 9 represents the distribution outside the undercurrent, and Station 7 represents the distribution in the undercurrent. There are clear differences in the distribution between the California Current and the undercurrent. At temperatures between 7°C and 10°C (depth 100–400 m), salinity at Station 7 is much higher and exhibits a well defined maximum centered near 150 cl/t of thermosteric anomaly. In the same temperature range, oxygen at Station 7 is about 1 ml/l lower than at Station 9.

The distributions of temperature and salinity are illustrated for the southernmost section off Del Mar (Figure 3). The shallow salinity minimum in the thermocline is derived from the California Current and is present everywhere on the section. The salinity maximum at about 300 m is associated with the northward undercurrent. The maximum is evident at Stations 10, 11, and 12, but Station 9 (shown in Figure 2) does not show any evidence of the undercurrent. The width of this high salinity water appears to be only 3 to 4 miles. On the temperature section, the isotherms for 8° and 9°C slope down toward the shore and suggest a northward geostrophic flow with its maximum speed at a depth of about 150 m, where isotherms are nearly level.

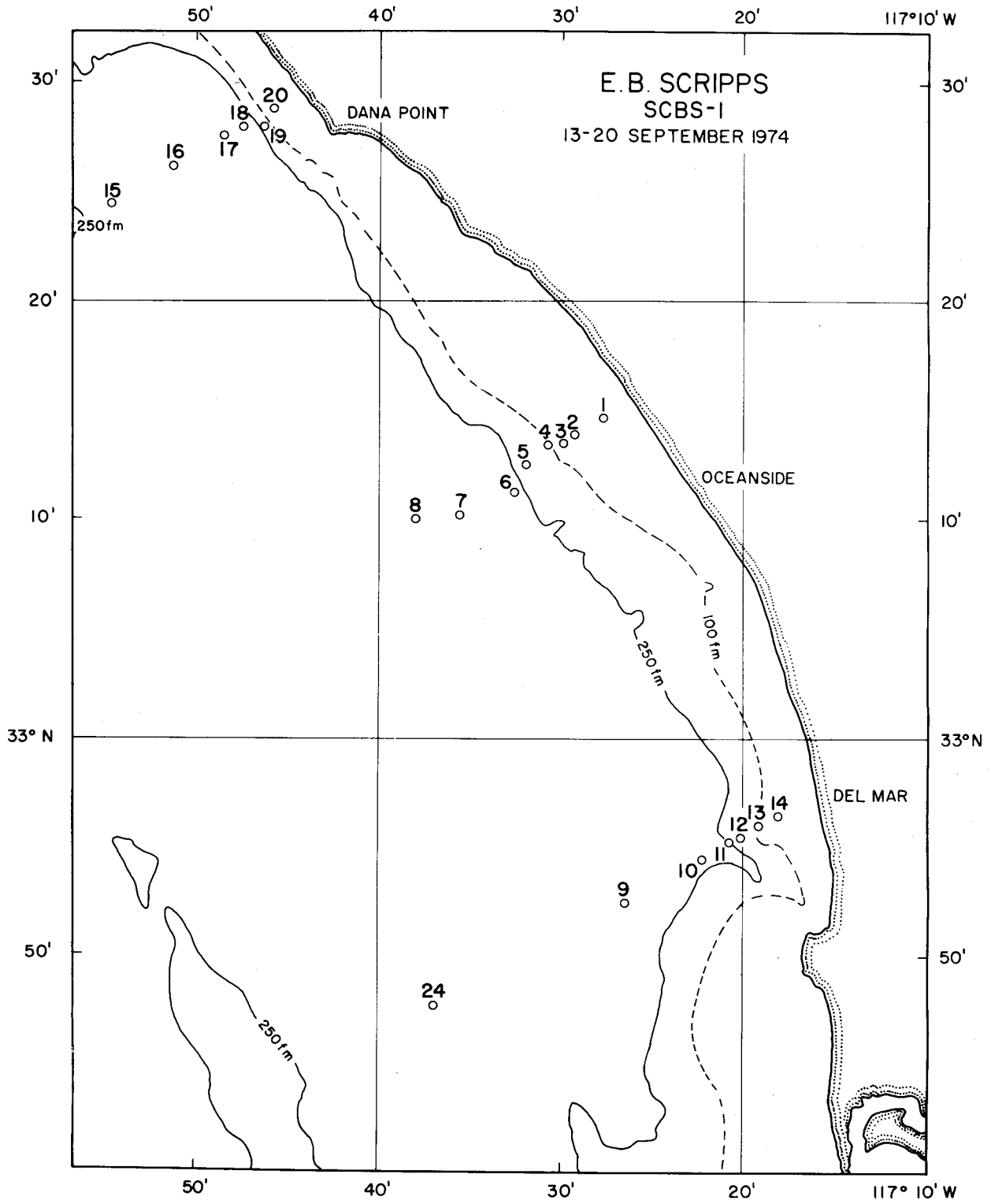

FIGURE 1. Station positions.

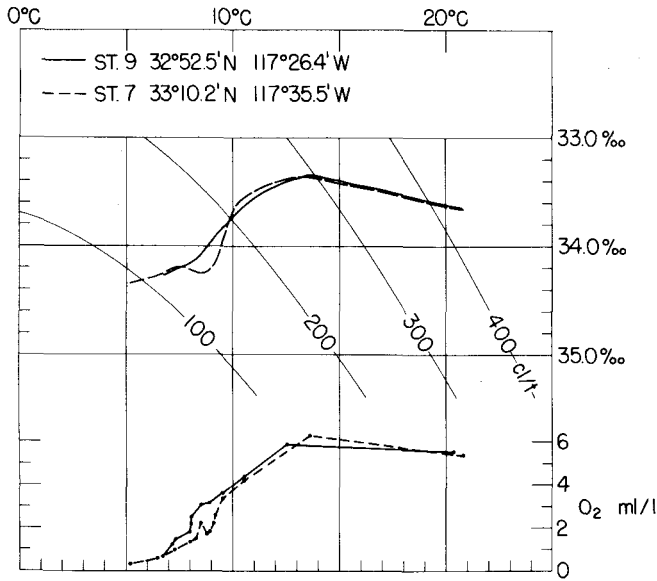

FIGURE 2. Temperature-salinity (top) and temperature-oxygen (bottom) curves (For station positions, see Figure 1).

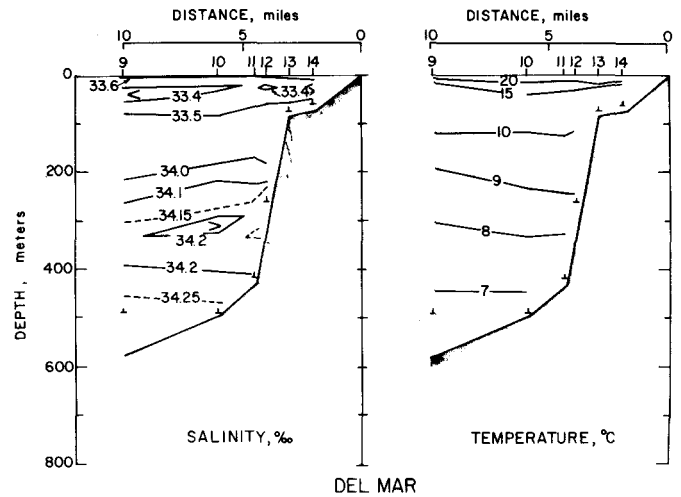

FIGURE 3. Vertical sections of temperature and salinity off Del Mar.

On the Oceanside section (Figure 4) 20 miles farther north, the salinity maximum is again apparent at Stations 7 and 8. The slope of the isotherms for 8° and 9°C between these stations is consistent with a northward geostrophic flow. The offshore portion of the undercurrent may have escaped from this section. Farther inshore, there is no evidence of the undercurrent except that isolated warm high salinity water is found at the bottom 30 m of Station 5 (not revealed by the isopleths in Figure 4).

On the northernmost section off Dana Point (Figure 5) there is no indication of high salinity water of equatorial origin. All stations show temperature-salinity and temperature-oxygen

curves characteristic of the California Current.

In summary, the distributions of properties observed in September 1974 suggest that a northward undercurrent only a few miles wide was present at 100–400 m in the southern half of the study area. It was located at distances 5 to 10 miles from the coast. However, in view of the fact that Station 23, made 50 miles off Del Mar, and Station 24 (Figure 1) indicated the presence of high salinity water of equatorial origin, the main flow or a branch of the undercurrent may have occurred farther offshore. Clearly, more field work is needed to obtain a clear picture of the California undercurrent in the Southern California Bight.

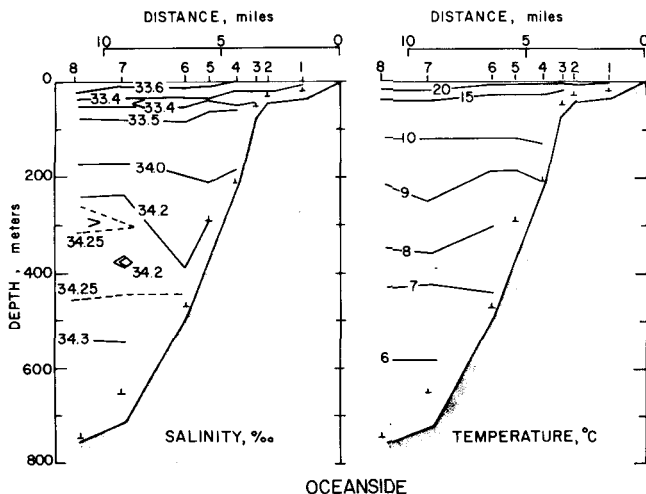

FIGURE 4. Vertical sections of temperature and salinity off Oceanside.

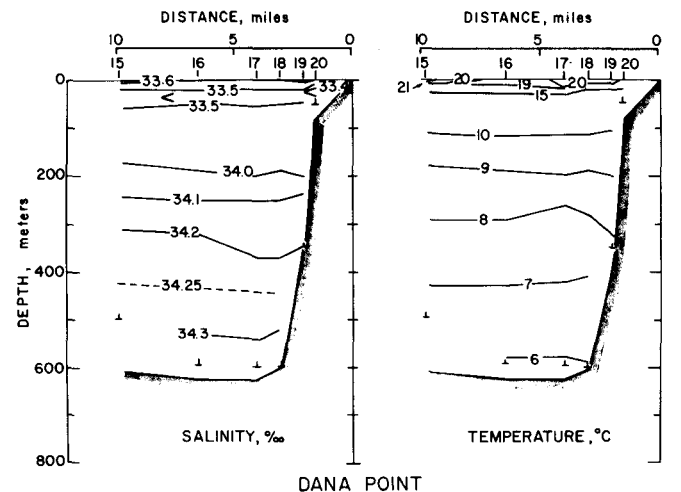

FIGURE 5. Vertical sections of temperature and salinity off Dana Point.

**ACKNOWLEDGMENTS**

This work was supported by the Atomic Energy Commission and by the Marine Life Research Program of the Scripps Institution of Oceanography.

**REFERENCES**

- Reid, J. L., Jr. 1963. Measurements of the California countercurrent off Baja California. *J. Geophys. Res.*, 68: 4819-4822.
- Reid, J. L., Jr., G. I. Roden, and J. G. Wyllie. 1958. Studies of the California Current system. *Calif. Coop. Ocean. Fish. Invest., Prog. Rept.*, 1 July 1956 to 1 January 1958: 27-56.
- Wooster, W. S., and J. H. Jones. 1970. California Undercurrent off northern Baja California. *J. Mar. Res.*, 28: 225-250.
- Wyllie, J. G., and R. J. Lynn. 1971. Distribution of temperature and salinity at 10 meters, 1960-1969, and mean temperature, salinity and oxygen at 150 meters, 1950-1968, in the California Current. *Calif. Coop. Ocean. Fish. Invest., Atlas*, (15): 1-188.

# SEDIMENT TRAP APPLICATIONS IN THE NEARSHORE REGION \*

FLOYD K. MITCHELL

Southern California Coastal  
Water Research Project  
El Segundo, California 90245

## ABSTRACT

The impact of a major sewage sludge discharge to Santa Monica Submarine Canyon off the Southern California coast has been studied using sediment traps to collect settling particulate matter in the vicinity of the discharge. The samples collected by the sediment traps revealed that both the fallout rates and the organic content of settling particulates are greatly influenced by the sludge discharge, but only in the immediate vicinity of the outfall. The particulate fallout rates and organic content were found to approach natural levels rapidly within a few kilometers of the discharge point. The discharged sludge was found to contribute less than 20% of the total particulate fallout and about 40% of the organic fallout to the Santa Monica Canyon ocean bottom.

## INTRODUCTION

Coastal population centers have traditionally used the ocean as a disposal site for treated municipal wastewaters and, in some cases, for treatment plant sludges as well. The wastewaters and sludges contain a complex mixture of organic and inorganic substances in both dissolved and particulate phases. In general, a major portion of the wastewater constituents considered to be potential pollutants (heavy metals, chlorinated hydrocarbons, and oil and grease) are associated with the particulate matter in the discharges. Consequently, a knowledge of the relatively immediate physical fate of the waste particulates is essential to an evaluation of the effects of wastewater discharges to the ocean. The use of sediment traps to collect samples of the settling particulate matter in the vicinity of wastewater outfalls is one method currently being used to gain such knowledge.

## SAMPLING AND ANALYTICAL PROCEDURES

The sediment trap being used at the Coastal Water Research Project was designed by Andrew Soutar of Scripps Institute of Oceanography and consists of an inverted cone with a 0.05m<sup>2</sup> collecting surface at the top and a removable sample container at the bottom. The entire device is supported on a tripod frame which holds the collecting surface approximately 2m above the ocean bottom. In 1974, four sediment traps were used to collect 29 samples at 22 stations over a period of about 7 months. The sampling period at each station ranged from 14 to 39 days and averaged 24 days.

\* Contribution 34 of the Coastal Water Research Project.

The samples were refrigerated once on board ship and frozen upon arrival at the Project's laboratory the same day (samples that were to be analyzed the next day were kept refrigerated overnight). We determined the total amount of particulate solids in the samples and the organic content of the solids, using procedures described below. In the future months, we also will analyze the collected solids for chemical oxygen demand, oil and grease, trace metals, and chlorinated hydrocarbons.

### *Total particulate solids procedure*

The samples were first centrifuged to concentrate the solids. The centrate was decanted and the wet solids transferred to a tared drying dish and weighed. The solids were dried at 80°C for 24 hours and weighed again. The sea salt content of the dry solids was estimated from the moisture loss, and this amount was subtracted from the weight of the dried solids (this correction ranged from negligible to 22%, depending upon the characteristics of the solids).

### *Solids organic content procedure*

A small subsample of the dried solids was redried and weighed. This sample was then ashed at 550°C for 1 hour, cooled in a dessicator, and reweighed. The value for the weight lost in ashing was adjusted for the weight lost from combustion of the volatile components of the sea salts present. The adjusted weight loss was considered to be due to the combustion and volatilization of the organic matter present in the sample and was used as a measure of the organic matter.

## STUDY DESCRIPTION AND RESULTS

The region selected for this study was the Santa Monica Canyon in Santa Monica Bay, California. The City of Los Angeles Hyperion Sewage Treatment Plant discharges 5 million gallons per day of a mixture of treatment plant sludges and secondary effluent at the head end of the canyon. About 131 metric tons of dry particulate solids per day are discharged through this system, and the organic content of these solids is usually between 60 and 70%. The objectives of the Coastal Water Project's study were to determine: (1) the rates of fallout of the discharged particulates at selected stations in the canyon region, and (2) the physical and chemical properties of the settling particulates at each station (limited to data on organic content at this time).

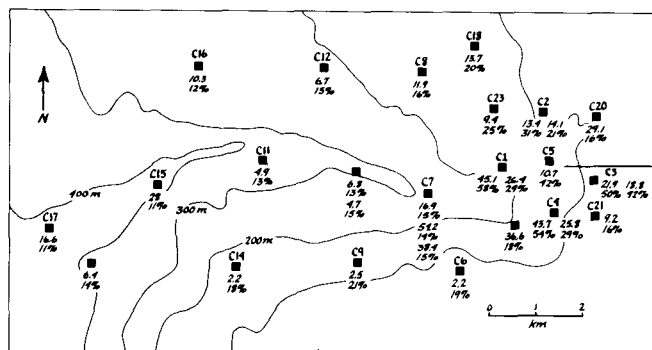

FIGURE 1. Santa Monica Canyon sediment trap stations, observed sedimentation rates ( $\text{gm}/\text{m}^2/\text{day}$ ), and organic content of trapped solids (%).

The calculated sedimentation rates ranged from 2.2 to 107  $\text{g}$  dry solids  $\text{m}^2/\text{day}$ , with the higher values occurring near the discharge point (Figure 1, Table 1). We took more than one sample at several of the stations to get an idea of the sedimentation rate variation from one sampling period to another: Five stations, C1, C2, C3, C4, and C10, were sampled twice, and one station, C7, was sampled three times. The observed deviations ranged from 2.5 to 54% of the mean station values, with an average deviation from the mean of 18%. As the quality and characteristics of the particulate matter discharged are fairly constant, these variations are probably due to changes with time in the water movement

TABLE 1  
Sediment Trap Data Summary 1974

Station	Sampling period	Total Solids		Organic content (%)
		Sample size (g)	Fallout rate ( $\text{g}/\text{sq m}/\text{day}$ )	
C1	5 Jun to 19 Jun	31.6	45.1	26.4
	19 Jun to 23 Jul	98.0	57.6	28.9
C2	5 Jun to 19 Jun	9.4	13.4	30.7
	19 Jun to 23 Jul	23.9	14.1	20.6
C3	5 Jun to 19 Jun	15.3	21.9	49.7
	19 Jun to 23 Jul	32.0	18.8	41.5
C4	5 Jun to 19 Jun	30.6	43.7	53.5
	19 Jun to 23 Jul	44.0	25.9	29.0
C5	23 Jul to 7 Aug	80.0	107.0	42.3
C6	15 Aug to 29 Aug	1.5	2.2	18.5
C7	4 Oct to 25 Oct	17.7	16.9	15.3
	25 Oct to 19 Nov	67.7	54.2	13.5
	19 Nov to 12 Dec	44.2	38.4	15.1
C8	23 Jul to 29 Aug	22.0	11.9	16.2
C9	29 Aug to 12 Sep	1.7	2.5	20.7
C10	4 Oct to 25 Oct	7.1	6.8	12.7
	25 Oct to 19 Nov	5.8	4.7	14.6
C11	29 Aug to 4 Oct	8.9	4.9	12.8
C12	29 Aug to 12 Sep	4.7	6.7	15.2
C13	29 Aug to 12 Sep	4.5	6.4	13.8
C14	12 Sep to 4 Oct	2.4	2.2	18.4
C15	4 Oct to 25 Oct	29.4	28.0	11.0
C16	12 Sep to 4 Oct	11.3	10.3	12.3
C17	12 Sep to 4 Oct	18.2	16.6	11.2
C18	4 Oct to 25 Oct	14.4	13.7	20.0
C19	12 Dec to 3 Jan	40.3	36.6	17.9
C20	12 Dec to 3 Jan	32.0	29.1	16.3
C21	25 Oct to 3 Jan	17.9	9.2	16.2
C23	19 Nov to 12 Dec	10.8	9.4	24.9

patterns in the canyon area. Variations in currents in the study area could change the speed and direction of discharged particulate transport and the quantity of resuspended surface sediments collected at any sediment trap station.

Current measurements were made at only one station, C17. Bottom currents at that station were recorded every 15 minutes for a period of 3 weeks in September 1974. The predominant currents recorded were downcanyon, with a net speed of 5.5  $\text{cm}/\text{sec}$ . The highest current speed recorded was 32  $\text{cm}/\text{sec}$ , and all currents greater than 25  $\text{cm}/\text{sec}$  were downcanyon.

To compare the sedimentation rates obtained with the amount of solids discharged on the basis of mass per unit time, we assigned areas to each of the stations and estimated the total mass flux over the study area ( $69 \text{ km}^2$ ). The estimated total solids fallout of 825 metric tons per day was 6.3 times the particulate solids discharge rate of 131 metric tons per day. The estimated organic solids fallout of 203 metric tons per day was 2.4 times the discharge rate of 85 metric tons per day.

The fact that there appeared to be much more particulate matter falling to the bottom of the canyon than was discharged at the head end may be the result of many factors. The sedimentation of marine particulate matter naturally occurring in the study area certainly accounted for some of the excess. No data have been found in the literature regarding sediment accumulation rates in submarine canyons. Emery (1960) studied sediment accumulation rates at several locations off the southern California coast and reported a net sediment accumulation rate of  $3.4 \text{ g}/\text{m}^2/\text{day}$  for a station in Santa Monica Basin, his sampling station closest to the Santa Monica Canyon. This number corresponds closely with the sedimentation rates measured in this study at stations distant from the outfall. Andrew Soutar (Scripps Institution of Oceanography, pers. comm.) has measured the fallout rates of particulate matter in eight basins off southern California, using sediment traps similar to those used in this study. The rates he recorded range from 0.23 to  $2.44 \text{ g}/\text{m}^2/\text{day}$ , with an average of  $0.74 \text{ g}/\text{m}^2/\text{day}$ . His value for Santa Monica Basin is  $0.69 \text{ g}/\text{m}^2/\text{day}$ , a factor of five lower than Emery's estimate.

It must be noted that the sediment traps collect falling matter. Thus, we are measuring particulate matter fallout rates, which may be quite different than sediment accumulation rates. Transport mechanisms such as bottom scour, which resuspends sediment and may greatly affect the sediment accumulation rate, are not operative within the sediment traps. The collection of resuspended sediments by the sediment traps is an unknown that could be significant. The speed of the canyon currents that we measured (9% of the observations

were greater than 20 cm/sec) are sufficient to cause scour and resuspension of unconsolidated sediments (Hjulstrom 1939; Southard, Young, and Hollister, 1971). In the future, we plan to compare the sedimentation rates with estimated sediment accumulation rates since 1960, when the waste discharge began, to get an estimate of the importance of scour and resuspension as a transport mechanism in the study area.

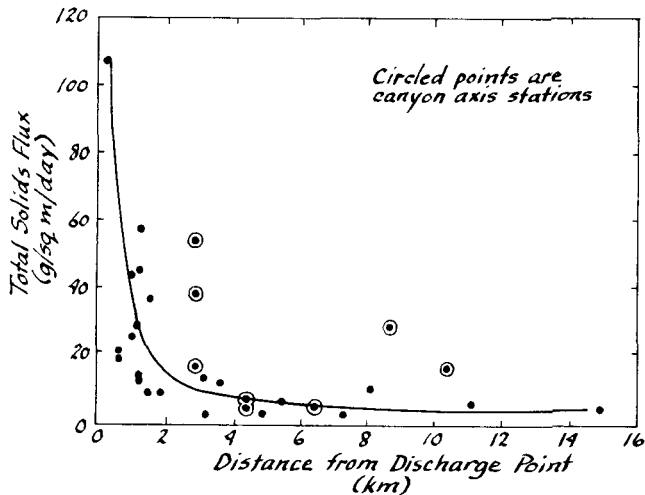

FIGURE 2. Observed sedimentation rates vs. location.

Most of the waste particulates discharged at the head of Santa Monica Canyon fall to the bottom within a few kilometers of the discharge point (Figure 2). A line indicating the trend of the data has been fitted by eye. The data are scattered about this proposed trend for a number of reasons, and some of this scatter appears not to be random. Beyond 2 km from the discharge point, the four obviously high data points are from canyon axis stations (C7, C15, and C17), and the three lowest points represent the three stations along the southern lip of the canyon (C6, C9, and C14). The influence of the outfall discharge on the flux of particulates to the bottom appeared to be greatest at or near the point of discharge and decreased rapidly within a distance of 2 to 3 km. Assuming a net current downcanyon of 5 cm/sec, this distance represents approximately 11 to 17 hours residence time in the water column for the settling wastewater particulates.

The organic content of the trapped solids decreases rapidly with distance from the discharge point (Figure 3). A line indicating the trend of the data has been fitted by eye. The shape of this curve is remarkably similar to that in Figure 2. The major influence of the discharged waste particulates, which average about 65% volatile solids, in determining the character of the particulate fallout was limited to an area within about 2 km of the discharge. If the effects of the waste particulates approach zero with increasing distance from the outfall, then the organic

content of the collected particulates should approach that of natural marine fallout. We can estimate the probable range for the organic content of natural fallout to be 10 to 15% (Figure 3). Two samples collected with sediment traps placed in Catalina Canyon were analyzed for organic content according to the procedures already described. The values for these were 11% and 12%, numbers which fit well with the hypothesis that most of the particulate matter collected by the sediment traps more than 2 km from the outfall is natural to the study area. Additional analyses of the chemical characteristics of the samples will be helpful in evaluating this interpretation of the data.

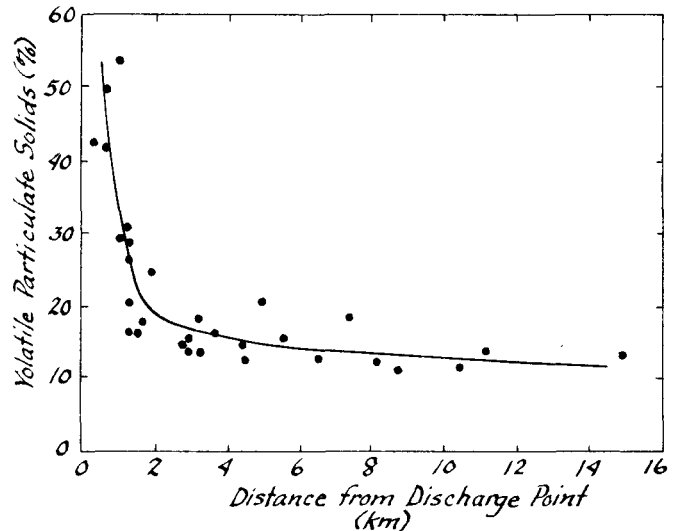

FIGURE 3. Organic content of settling particulates vs. location.

### CONCLUSIONS

Although much of the data from this study are not yet available, the following preliminary conclusions have been made, based upon data presented in this paper.

1. Sediment traps are useful devices for the collection of settling particulate matter in the ocean.
2. Most of the waste particulates discharged at the head of Santa Monica Canyon fall to the bottom within a distance of 2 km of the point of discharge.
3. Natural fallout in the Santa Monica Canyon is in the range of 2 to 20 g/m<sup>2</sup>/day, with an organic content of 10 to 15%. High deposition rates occur aperiodically, primarily along the canyon axis; these probably result from resuspension and transport of the sediment by strong bottom currents.

### REFERENCES

- Emery, K. O., 1960. The sea off southern California. New York: Wiley & Sons, page 254.
- Hjulstrom, F., 1939. Transportation of detritus by moving water. In Recent Marine Sediments, A Symposium, P. D. Trask, ed. Tulsa, Okla. The American Assoc. of Petroleum Geologists, page 5.
- Southard, J. B., R. A. Young, and C. D. Hollister, 1971. Experimental erosion of calcareous ooze. J. Geophys. Res., 76: 5903-9.

# TRACE ELEMENT ANOMALIES IN MARINE ORGANISMS OFF SOUTHERN CALIFORNIA \*

DAVID R. YOUNG and DEIRDRE J. McDERMOTT

*Southern California Coastal  
Water Research Project  
El Segundo, California 90245*

## ABSTRACT

Large quantities of DDT and trace metals are released annually to the coastal marine ecosystem off southern California via municipal wastewaters discharged through five major submarine outfall systems. Samples of the California seamussel, *Mytilus californianus*, and the Dover sole, *Microstomus pacificus*, were collected from throughout the Southern California Bight to determine if, around these local point sources, contamination of the nearshore biota had occurred. Highest DDT levels in seamussels were observed in specimens collected from the vicinity of a major outfall which, in the past, discharged effluents containing industrial wastes from the manufacture of this pesticide. Copper levels were significantly higher in urban seamussels than in either rural or island control specimens. In contrast, cadmium concentrations were significantly lower in the urban samples. Lead appears to be a wide spread contaminant of the southern California coastal region. Concentrations of chromium were highest in rural seamussels and silver concentration were highest in urban specimens. No significant differences in the nickel and zinc levels were observed between seamussels from any of the three regions. Similarly, no significant enhancements in the trace metal concentrations measured in Dover sole livers were observed despite the close association of the specimens with highly contaminated sediments.

## INTRODUCTION

In recent years there has been increasing concern about pollution of coastal marine ecosystems. One aspect of this concern that has received considerable attention is the possibility that trace elements released to this environment through man's actions are being accumulated by organisms to unnatural levels that endanger both their health and their usefulness as seafood. Here we report results of studies into anomalous concentrations of 11 trace elements in two very different marine organisms, an intertidal mollusc, the California seamussel, *Mytilus californianus*, and a nearshore flatfish, the Dover sole, *Microstomus pacificus*, found off the densely populated coastal plain of southern California.

Approximately 11 million persons, or 5% of the Nation's population, inhabits the region between Point Conception and the U.S. Mexico border

\* Contribution 39 of the Southern California Coastal Water Research Project.

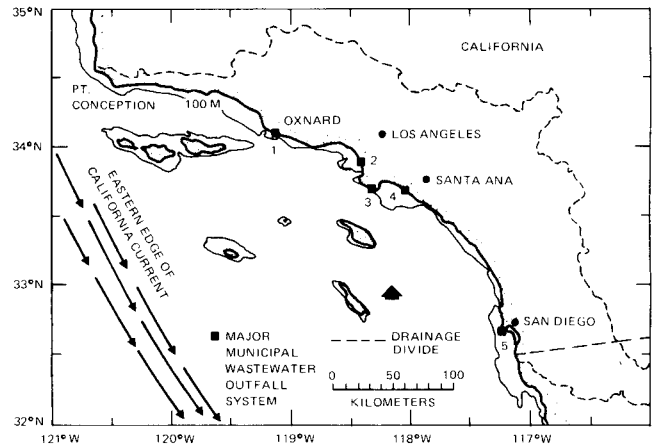

FIGURE 1. The Southern California Bight. Outfall systems are (1) Oxnard City, (2) Hyperion, Los Angeles City, (3) Joint Water Pollution Control Plant (JWPCP), Los Angeles County, (4) Orange County, and (5) San Diego City.

(Figure 1). Most of these people live in the Los Angeles/Orange County Basin\* or near San Diego. The municipal wastewaters from these communities in large part are discharged from submarine outfalls a few kilometers offshore, generally at depths shallower than 100 m. Such discharges now total more than 1 billion gallons per day (approximately  $1.4 \times 10^{12}$  l/yr), comparable to the 1941-70 median annual flow of  $1 \times 10^{12}$  liters from surface runoff (United States Geological Survey, 1974). Approximately 95% of this municipal wastewater passes through five major treatment plants, where it generally undergoes only primary settling of solids

\* Centered around the cities of Los Angeles and Santa Ana.

TABLE 1  
Average trace element concentrations (mg/dry kg) in two types of particulates in the Bight \*

Trace element	Percent associated with wastewater particulates	Wastewater particulates	Natural nearshore marine sediments
Silver.....	88	100	1.0
Cadmium.....	93	130	0.4
Chromium.....	84	1500	46
Copper.....	91	1600	16
Mercury.....	90†	4†	0.04
Nickel.....	58	350	14
Lead.....	94	610	8.5
Zinc.....	92	3000	63

\* After Galloway, 1972a and Young et al., 1973.

† Estimates for Joint Water Pollution Control Plant (JWPCP) effluent only.



before release (Southern California Coastal Water Research Project, 1973).

Young, Young, and Hlavka (1973) have summarized the importance of these wastewaters as sources of trace metals to the coastal ecosystem. For a number of metals, discharges from these systems contribute either a majority or a significant fraction of the estimated total input from the coastal plain. In collaboration with J. Galloway (University of California, San Diego), we found that most of these metals are associated with filterable particulates, and that the concentrations on such effluent solids are often two orders of magnitude above natural levels for bottom sediments found around the submarine outfalls (Table 1).

### DDT AND TRACE METALS IN CALIFORNIA SEAMUSSELS

It has been shown that at least one chemical constituent of municipal wastewater can significantly contaminate the marine biota over a wide area. During summer 1971, we collected intertidal California seamussels, *M. californianus*, from coastal and island stations throughout the Southern California Bight. The whole soft tissues of specimens 4 to 6 cm in length were analyzed for chlorinated hydrocarbons by B. de Lappe and R. Risebrough at Bodega Marine Laboratory. Data on resultant DDT concentrations illustrate the striking effect one outfall system has had on residue levels of this pesticide in an intertidal invertebrate (Figure 2). Values decreased by factors of 50 to 100 in five directions away from Palos Verdes Peninsula, the site of the outfalls of County Sanitation Districts of Los Angeles County. The source apparently was industrial DDT wastes released in very large quantities from a manufacturer of the pesticide over an undetermined period. During 1971, 20 metric tons of this waste were carried to the sea via effluent discharged from the Joint Water Pollution Control

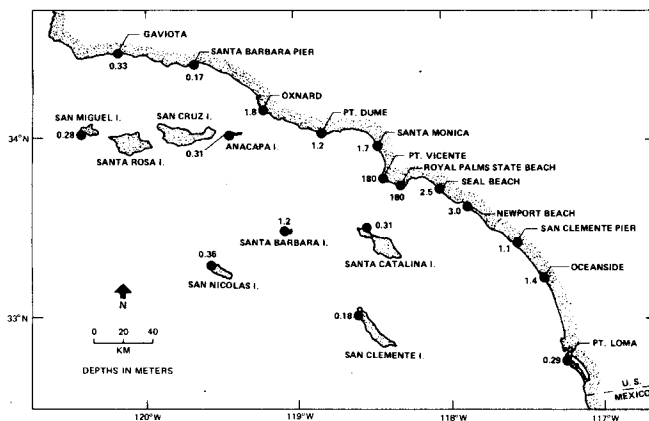

FIGURE 2. Total DDT concentrations (mg/dry kg) in whole soft tissues of California seamussel, *Mytilus californianus*, 1971. Average wet to dry weight ratio for these samples was 4.4 (Analyses by B. de Lappe and R. Risebrough).

Plant, and we found 200 metric tons in the bottom sediments of the Palos Verdes shelf the following year (McDermott, Heesen, and Young, 1974).

To determine if there was corresponding widespread contamination of the nearshore biota from anthropogenic inputs of trace metals, digestive glands of seamussels obtained from the 1971 collection were analyzed by G. Alexander utilizing optical emission spectroscopy at the University of California, Los Angeles. Composites of this tissue from three male and three female specimens were measured, and application of the Wilcoxon signed-rank test revealed no significant effect of sex on the resultant metal concentrations.

The results do not indicate dramatic copper contamination of the intertidal zone off Los Angeles and Orange Counties (Figure 3), despite the fact that we estimate more than 500 metric tons of this metal were discharged during 1971 via municipal

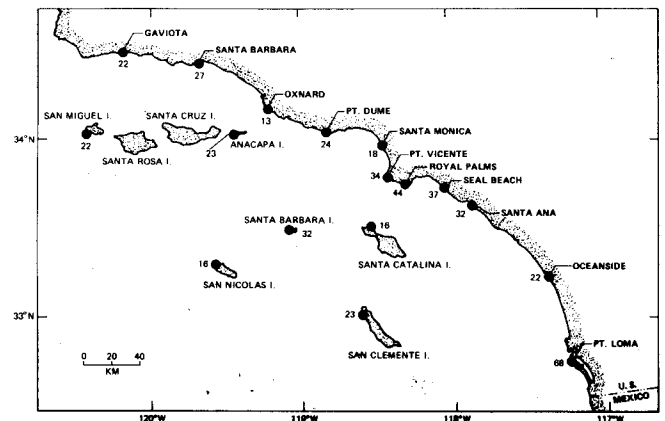

FIGURE 3. Copper concentrations (mg/dry kg) in digestive gland tissue of California seamussel, *Mytilus californianus*, 1971. Average wet to dry weight ratio for these samples was 3.8 (Analyses by G. Alexander).

wastewaters from the three largest submarine outfall systems\* of the bight. In contrast, analyses of trace metals in surface runoff conducted in collaboration with J. Morgan, California Institute of Technology, indicated that only about 14 metric tons of copper were carried into the marine environment by storm runoff from these two Counties. While large gradients were not observed, there is a suggestion of somewhat elevated values in mussels collected between Palos Verdes Peninsula and Newport Beach, and off Point Loma in San Diego.

Although these higher concentrations found off the major urban areas might be attributed to municipal wastewater inputs, we recently have reported another potentially important source of copper to the coastal ecosystem (Young, Heesen, McDermott, and Smokler, 1974). Approximately 200 metric tons of this metal in antifouling paints are

\* Hyperion Treatment Plant, City of Los Angeles: 340 mgd; JWPCP, County Sanitation District of Los Angeles County: 370 mgd; Orange County Sanitation District: 130 mgd.

applied annually to vessels in the Southern California Bight, with 120 metric tons being used at anchorages between Santa Monica and Newport Beach, and 50 metric tons being used at Mission and San Diego Bays near Point Loma. In contrast, San Diego municipal wastewater introduced only about 20 metric tons of copper off Point Loma during 1971. The highest copper concentrations (average: 68 ppm) found in the 1971 seamussel survey occurred on Point Loma between these two important San Diego anchorages, while the two next highest values (44 and 37 ppm) occurred to the north and south of San Pedro Harbor. Because the copper additives in antifouling paints are designed to effect marine invertebrates, such paints must be considered a candidate along with municipal wastewater as potential sources of the enhanced copper concentrations implied by the distribution found in *M. californianus*.

In addition to municipal wastewater discharges and vessel-related activities, there are other potentially important anthropogenic sources of trace metals to the coastal zone, such as aerial fallout from atmospheric pollutants and direct industrial discharges. Although they have not been adequately quantified to date, the impact of these and other inputs associated principally with major population centers were assessed by evaluating any significant differences in concentration levels of potentially toxic trace elements in the 1971 intertidal mussels collected from three distinct population regions.

We utilized a statistical test developed by Tukey (1953) which allows for multiple comparisons between an unlimited number of groups. The one restriction is that there must be an equal number of sample points per group. Therefore, we separated the intertidal stations into three distinct population groups with five station values for each of the metals analyzed. The urban coastal group included Palos

Verdes Peninsula, Santa Monica, Seal Beach, Newport Beach, and Point Loma. The Palos Verdes value was obtained by combining the concentrations from the Royal Palm and Pt. Vicente stations, which are located on the Peninsula near the JWPCP outfalls. The rural coastal group consisted of Gaviota, Santa Barbara, Oxnard, Point Dume, and Oceanside. Island control stations included San Miguel, Anacapa, San Nicolas, Santa Catalina, and San Clemente Islands. Santa Barbara Island was not included because the total DDT concentrations in mussels from this station were approximately five times that of the average for the other islands (Figure 2), suggesting an important influence of the JWPCP outfalls off Palos Verdes Peninsula.

The results of the analysis for the seven trace metals considered show that relatively constant values of about 20 mg/dry kg (ppm) lead were observed in both the urban and rural coastal zones, and that this level was significantly higher than the island mean of 6 ppm (Table 2). Only those differences between digestive gland concentrations which are statistically significant at the 95 percent confidence level are listed. This distribution may be a result, in part, of the large quantity (approximately 7000 tons) of tetraethyl lead burned annually in internal combustion engines and introduced via automotive exhaust to the coastal plain (Huntzicker, Friedlander, and Davidson, 1975).

Of the remaining six metals, the mean urban copper concentration (38 ppm) was significantly higher than both the rural and island means (22 and 20 ppm, respectively). For silver the urban mean (26 ppm) was significantly higher than the island mean (10 ppm), but not the rural mean (12 ppm). In the case of cadmium, the urban mean (14 ppm) was significantly lower than both the rural and island means (26 and 21 ppm, respectively). For chromium, the rural mean (15 ppm) was significantly higher than both the urban and island means (5 and 2 ppm, respectively). In the case of nickel and zinc, no significant differences between groups were observed; bight-wide averages for these two metals were 8 and 76 ppm, respectively.

Although individual results for these seven potential pollutants are quite varied, a general conclusion which may be drawn from this comparison is that there does not appear to be a pattern of dramatic urban enhancements of the trace metals analyzed in this intertidal invertebrate. Urban depressions as well as enhancements are observed, and regional group means generally agree within a factor of two or three. The biological implications of such variations are not yet well understood.

#### TRACE METALS IN DOVER SOLE

Following this regional survey, we conducted an intensive investigation into trace element

TABLE 2

Average trace element concentrations (mg/dry kg) in digestive glands of the California seamussel, *Mytilus californianus*, showing significant regional differences \* off southern California.

Trace element	Urban vs Island	Urban vs Rural	Rural vs Island
Silver.....	U > I (26) (10)	--	--
Cadmium.....	U < I (14) (21)	U < R (14) (26)	--
Chromium.....	--	U < R ( 5) (15)	R > I (15) ( 2)
Copper.....	U > I (38) (20)	U > R (38) (22)	--
Nickel.....	--	--	--
Lead.....	U > I (18) ( 6)	--	R > I (21) ( 6)
Zinc.....	--	--	--

\* 95% Confidence limit.

contamination of a benthic flatfish commonly found around local submarine outfalls. The Dover sole, *M. pacificus*, was initially selected because of its high incidence of fin erosion disease with increased proximity of trawling location to an urban source of contamination. This source, the JWPCP submarine outfall system, discharged on the average more than 50% of the trace metals, under consideration here, which were released via municipal waste in 1971. Similarly, over 90% of the total amount of DDT released to the local marine environment during 1971-72 was discharged via this outfall. Enhanced muscle tissue concentrations of DDT compounds in fish collected around this discharge indicated that specimens trawled from the Palos Verdes shelf have resided there for an extended period of time. This apparent localization of the species makes it a viable choice for studying regional differences.

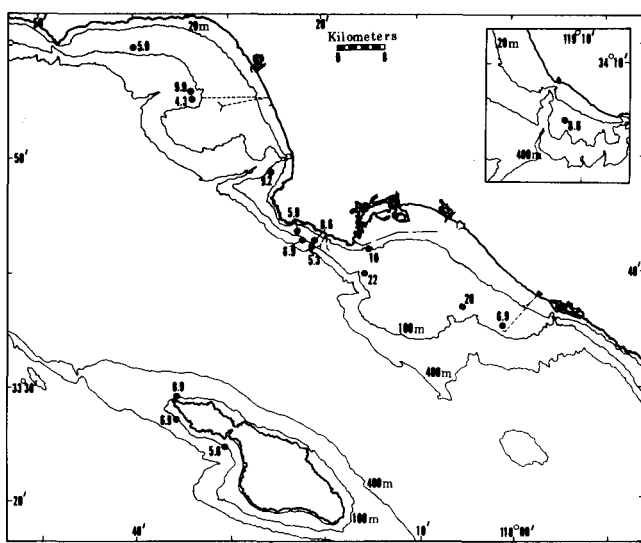

FIGURE 4. Copper concentrations (mg/dry kg) in liver tissue of Dover sole, *Microstomus pacificus*, 1970-71. Average wet to dry weight ratio for these samples was 3.3 (Analyses by J. de Goeij and V. Guinn).

In collaboration with V. Guinn and J. de Goeij (University of California at Irvine), liver tissue of Dover sole collected during 1971-72 from around the three largest discharges of municipal wastewater in the bight (and control stations off Catalina Island) were analyzed by neutron activation analysis. Median body lengths for the outfall and control specimens were 242 and 180 mm, respectively. The distribution observed for copper in this flatfish (Figure 4) does not indicate any enhancement of liver tissue concentrations of this metal in Dover sole trawled from the discharge regions of the three large outfall systems off Santa Monica, Palos Verdes Peninsula, and Newport Beach; concentrations around these outfalls, and those of the Catalina Island control stations, all averaged about 7 mg/dry kg (ppm). The two highest values measured (22 and 20

ppm) occurred to the south of San Pedro Harbor, the largest anchorage in the bight. This again suggests the possible importance of copper in vessel antifouling paints as a significant source of this contaminant to coastal marine organisms.

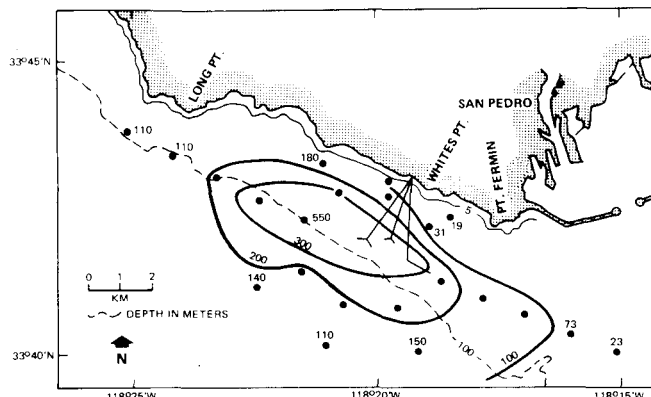

FIGURE 5. Copper concentrations (mg/dry kg) in surface sediments around the Joint Water Pollution Control Plant (JWPCP) outfall system, May 1970 (Analyses by J. Galloway).

Eight of the trace elements detected in these samples had previously been shown to be highly concentrated in bottom sediments around the JWPCP outfalls (Galloway, 1972b; Southern California Coastal Water Research Project, 1973). The contamination patterns for these elements (Figure 5) generally follow those illustrated for copper. From these data, we have estimated typical contamination factors (relative to natural sediment concentrations) for the sediments from which the Palos Verdes outfall specimens were trawled (Table 3). With the exception of silver, these elements are seen to contaminate the surface sediments in this region by average factors of 13 to 160 above estimated natural concentrations.

TABLE 3

Average trace element concentrations (mg/dry kg) in liver tissue from Dover sole, *Microstomus pacificus*, trawled from the Palos Verdes Peninsula outfall region and from a control region off Santa Catalina Island, 1970-72.\*

Trace element	Sediments† Outfall‡: Control	Dover sole livers	
		Outfall	Control
Silver.....	3.0	5.9	7.3
Arsenic.....	15	4.3	10
Cadmium.....	160	0.63	1.9
Copper.....	23	6.6	7.3
Mercury.....	85	0.36	0.36
Antimony.....	13	0.010	0.012
Selenium.....	14	2.1	4.0
Zinc.....	17	86	89

\* After deGoeij *et al.*, 1974.

† Typical trace element contamination factors in surface sediments off Palos Verdes Peninsula.

‡ Specimens from the region termed "very high contamination" by de Goeij *et al.* (1974), within 2 km to the northwest of the Joint Water Pollution Control Plant (JWPCP) submarine outfalls.

In contrast, when compared with control specimens, Dover sole, known by their high DDT concentration and eroded fins to have inhabited the contaminated Palos Verdes outfall sediments, did not exhibit a corresponding enhancement in the concentration of the eight trace elements measured in their liver tissue. The comparison between levels found in the outfall and island control specimens indicate the outfall fish liver concentrations in all cases were slightly lower than the control concentrations, and that the average silver, copper, mercury, antimony, and zinc values generally agreed within 10% of the mean for this flatfish from the two regions. However, for arsenic, cadmium, and selenium, the outfall specimens had significantly lower concentrations, at the 95% confidence level, than the controls. These relative depression were within a factor of two to three. Such depressions are of considerable biological interest, and we are now attempting to learn more about them and their ecological significance.

In summary, these investigations have not revealed any dramatic regional or local enhancement of trace element concentrations in the nearshore biota off southern California, although man has introduced significant quantities of such contaminants to this coastal ecosystem. Both statistically significant enhancements and depressions have been observed for various elements in the mussel and flatfish analyzed; however, such concentrations generally agree with control values within a factor of two or three. Our studies into levels of these and other important trace elements in marine organisms from the Southern California Bight are continuing.

#### ACKNOWLEDGMENTS

We wish to thank the following individuals with whom we have collaborated in this research: James Galloway (University of California, San Diego),

Brock de Lappe and Robert Risebrough (University of California, Berkeley), George Alexander (University of California, Los Angeles), James Morgan and James Rath (California Institute of Technology, Pasadena), Jeroen de Goeij and Vicent Guinn (University of California, Irvine), and Alan Mearns (of this Project).

#### REFERENCES

- de Goeij, J. J. M., V. P. Guinn, D. R. Young, and A. J. Mearns. 1974. Neutron activation analyses trace-element studies of Dover sole liver and marine sediments. In: *Comparative Studies of Food and Environmental Contamination: 189-200*. Int'l Atomic Energy Agency, Vienna.
- Galloway, J. N. 1972a. Man's alteration of the natural geochemical cycle of selected trace metals. Ph.D. dissertation, Univ. of Calif., San Diego. 143 p.
- Galloway, J. N. 1972b. Global concepts of environmental contamination. *Mar. Pollut. Bull.*, 3: 78-79.
- Huntzicker, J. J., S. K. Friedlander, and C. I. Davidson. 1975. A material balance for automobile emitted lead in the Los Angeles Basin. *Environ. Sci. and Tech.*, 9: 448-57.
- McDermott, D. J., T. C. Heesen, and D. R. Young. 1974. DDT in bottom sediments around five southern California outfall systems. TM 217. So. Calif. Coastal Wat. Res. Proj., El Segundo. 54 p.
- Southern California Coastal Water Research Project. 1973. The ecology of the Southern California Bight: Implications for water quality management. TR 104. So. Calif. Coastal Wat. Res. Proj., El Segundo. 531 p.
- Tukey, J. W. 1953. Some selected quick and easy methods of statistical analysis. *New York Acad. Sci. Trans., Ser. II.*, 16(2): 88-97.
- United States Geological Survey. 1974. Water resources data for California, 1972. U.S. Department of the Interior, Geological Survey. 512 p.
- Young, D. R., C. S. Young, and G. E. Hlavka. 1973. Sources of trace metals from highly urbanized southern California to the adjacent marine ecosystem. In: *Cycling and Control of Metals: 21-39*. U.S. Envir. Protec. Agency, Nat'l. Envir. Res. Center, Cincinnati, Ohio.
- Young, D. R., T. C. Heesen, D. J. McDermott, P. E. Smokler. 1974. Marine inputs of polychlorinated biphenyls and copper from vessel antifouling paints. TM 212. So. Calif. Coastal Wat. Res. Proj., El Segundo. 20 p.

# REPORT OF NEUSTON (SURFACE) COLLECTIONS MADE ON AN EXTENDED CalCOFI CRUISE DURING MAY 1972

ELBERT H. AHLSTROM AND ELIZABETH STEVENS

National Oceanic and Atmospheric Administration  
National Marine Fisheries Service  
Southwest Fisheries Center  
La Jolla, California 92038

## ABSTRACT

This is the first report on neuston samples collected during CalCOFI cruises. Fortunately, Cruise 7205 covered an extensive area of the temperate north Pacific.

Some fish spend their young stages in surface waters or migrate into this zone diurnally, particularly at night. For these the neuston collections provide insights that cannot be observed in the standard oblique plankton collections. The neuston net samples some species in far greater numbers—the Pacific saury is a prime example—and so is an excellent tool for establishing distribution and relative abundances. The neuston net samples a higher proportion of large larvae of some species, the northern anchovy for example, than does the oblique net, and so may become a valuable tool in mortality determinations. Other genera in which the neuston net sampled larger larvae than are usually taken in the oblique net include *Sebastes*, *Anoplopoma*, and *Macrorhamphosus*. The neuston collections of oceanic fishes in the family Myctophidae demonstrate interesting behavioral pattern differences between its two subfamilies. In one subfamily, Myctophinae, only juveniles and adults were taken. In the subfamily Lampanyctinae only larvae were taken. This marked contrast in behavioral pattern of the two subfamilies is not evident in oblique hauls.

The comparison of the neuston and oblique plankton collections shows the neuston net to be a highly selective gear, sampling some species in much greater abundance than the oblique net but also sampling far fewer species than the oblique plankton net. The neuston net presents interesting potentialities when used in addition to the standard oblique net.

## ACKNOWLEDGMENTS

We wish to thank the following people for their help in the preparation of this paper: Walter Nellen of the Institut für Meereskunde, University of Kiel; Herbert W. Frey of the California Department of Fish and Game; and our associate H. G. Moser for reviewing the manuscript; Roy M. Allen of the Southwest Fisheries Center for preparing the figures; Henry M. Orr of the Southwest Fisheries Center for sorting and identifying some of the samples and for drawing the series of *Anoplopoma*

*fimbria*; and Patricia Lowery, formerly of the Smithsonian Institution, for completing the sorting of the samples.

## INTRODUCTION

This is the first report on neuston net collections made on cruises of the California Cooperative Oceanic Fisheries Investigations (CalCOFI). The collections were taken on extended Cruise 7205 which covered the cardinal lines of the regular CalCOFI pattern from line 10 off Puget Sound to Line 150 off southern Baja California as well as the terminal line, line 157 below Cape San Lucas, Baja California, a north-south extent of 1,680 miles (48° to 20° N). In addition, extensive offshore coverage was achieved by adding eight lines of offshore stations west of the CalCOFI pattern along latitudes 20°, 24°, 27°, 31°, 35°, 39°, 42°, and 46° N, extending offshore usually to 145° W longitude (Figure 1). This coverage is almost as extensive as that obtained by CalCOFI vessels on the cooperative NORPAC Expedition of 1955. A total of 105 neuston hauls was obtained over the regular CalCOFI grid and 43 hauls on the eight offshore lines.

## METHODS AND EQUIPMENT

The neuston net hauls were made simultaneously with the oblique plankton tows. This was achieved by launching the neuston net from a different winch located on the opposite side of the vessel simultaneously with the launching of the net assembly for the oblique hauls; it was retrieved at the same instant as the oblique tow. Speed of hauling was 1.5 to 2 knots. The duration of the haul averaged 21.5 minutes. Inasmuch as we wish to compare the catches made by the two types of hauls, neuston versus oblique, only those stations are included where both types of catches were made.

The neuston net used on this CalCOFI cruise was anything but sophisticated. A CalCOFI meter net frame (1.0 m diameter) was bent from round to ovoid, and a styrofoam float was fastened in either side of the mouth of the net. The floats maintained the net so that only about half of the mouth was under water. A standard CalCOFI net constructed of 505 micron mesh was utilized. It is estimated that the effective straining area at the mouth was about 0.3 m<sup>2</sup>. As might be anticipated, the net performed consistently well in relatively calm seas, and less so in

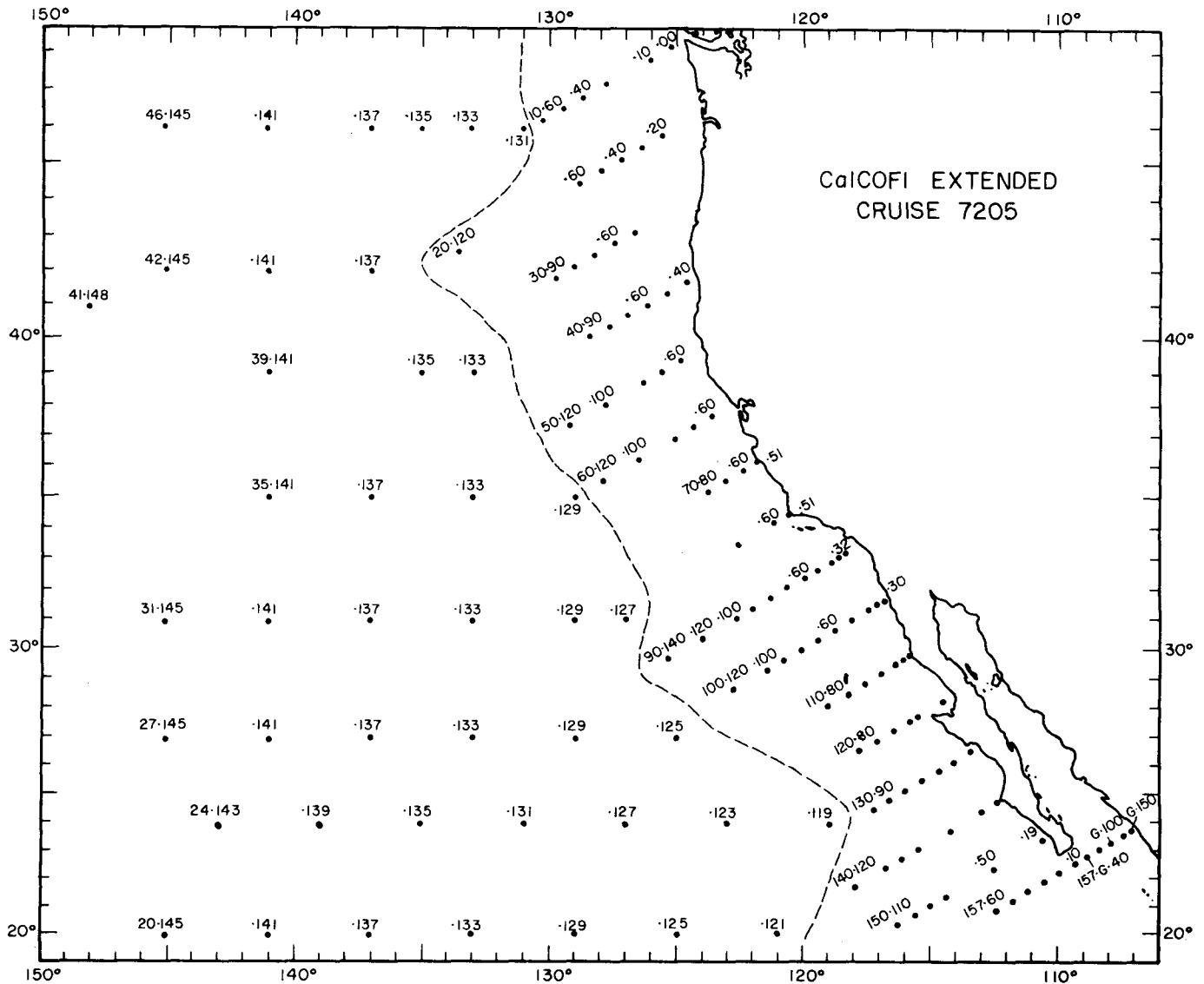

FIGURE 1. Station pattern for CalCOFI extended Cruise 7205.

more turbulent seas. The amount of water strained by the neuston net in moderate seas is estimated to be between 250 to 300 m<sup>3</sup>. No current meter was used in the neuston net; however, a current meter was used in taking the simultaneous oblique haul, also utilizing a 505 micron mesh CalCOFI net. Information on distance traversed during each haul can be derived from this current meter's readings. The regular CalCOFI net was lowered to about 200 m depth (300 m of wire payed out) and retrieved at a uniform rate.

The regular CalCOFI cruises do not extend far enough offshore to completely delimit the spawning distribution of jack mackerel, *Trachurus symmetricus*, or of the Pacific saury, *Cololabis saira*. Eggs and larvae of these two species usually are at or near their peak abundance during May. Cruise 7205 was designed, in part, to more effectively sample the offshore distributions of these two species. As our

results will demonstrate, the neuston net is a much more effective gear for sampling the larvae and juveniles of the Pacific saury than is our CalCOFI gear. Although both nets sampled eggs and larvae of jack mackerel, the CalCOFI oblique hauls obtained these in more collections.

## RESULTS

### *Number of Specimens Taken*

In the following discussion and throughout this presentation, we are dealing with actual counts of specimens taken in hauls. No attempt has been made to standardize the counts since there is no simple way to standardize counts from neuston hauls.

The number of fish larvae per collection in the neuston net ranged from zero to 1,039. Numbers of specimens per haul were grouped in six categories of abundance for both neuston and oblique hauls

TABLE 1  
Summary for Six Abundance Categories of Number of Larvae per Collection for Neuston Hauls and Oblique CalCOFI Net Hauls on Extended CalCOFI Cruise 7205

Lines	Neuston net collections								Oblique net collections							
	Number larvae per haul								Number larvae per haul							
	0	1-10	11-50	51-100	101-1,000	over 1,000	Total	Average no./station	0	1-10	11-50	51-100	101-1,000	over 1,000	Total	Average no./station
Regular CalCOFI pattern																
10-50	11	12	1	3	1	0	28	31.2	2	8	15	3	0	0	28	21.8
60-100	3	14	9	3	4	0	33	75.6	0	4	11	4	12	2	33	248.8
110-150	1	13	13	2	3	1	33	58.8	0	4	10	4	13	2	33	215.4
157	1	1	2	2	5	0	11	156.6	0	0	2	1	8	0	11	354.5
Subtotal	16	40	25	10	13	1	105	67.0	2	16	38	12	33	4	105	188.8
Offshore latitudinal lines																
46-41	6	3	1	0	0	0	10	2.2	0	1	9	0	0	0	10	26.6
39-31	2	3	5	2	1	0	13	33.4	0	1	3	3	6	0	13	78.5
27-20	0	4	12	4	0	0	20	28.6	0	0	4	6	10	0	20	130.6
Subtotal	8	10	18	6	1	0	43	23.9	0	2	16	9	16	0	43	90.7
Total	24	50	43	16	14	1	148		2	18	54	21	49	4	148	
% of total whole numbers	16	34	29	11	9	1	100		1	12	37	14	33	3		

(Table 1). Fewer larvae were taken on the average in neuston hauls. Samples having zero to 10 larvae made up fully 50%; with zero hauls contributing 16%, hauls with one to 10 larvae, 34%. The contributions of other abundance categories was as follows: samples with 11 to 50 specimens, 29%, samples with 51 to 100 specimens, 11%, and samples with 101 or more, 10%.

In the oblique hauls, 50% had 50 or fewer larvae; with two zero hauls contributing slightly more than 1%, hauls with one to 10 larvae comprising 12% and hauls with 11 to 50 larvae, 37%. One-half of the oblique hauls contained 51 or more larvae, with 3% containing over 1,000 larvae, 33% with 101 to 1,000 larvae, and 14% with 51 to 100 larvae.

Fewer larvae were taken in the northern part of the survey area than elsewhere by both types of plankton hauls. Thus, on the upper five lines (10 to 50) of the regular CalCOFI grid, an average of only 22 larvae per haul was obtained in oblique hauls, whereas an average of fully 10 times as many larvae per haul was obtained from the remainder of the CalCOFI pattern.

The contrast in numbers between the two types of hauls was most pronounced on the two northern offshore latitudinal lines (along latitude 46° and 41°) where only 2.2 specimens per haul were taken by the neuston net as compared to 26.6 specimens per haul in oblique collections. Over the regular CalCOFI pattern, the average catch in the neuston hauls was approximately one-third that taken in oblique hauls, and was somewhat less than one-third in offshore stations.

**Kinds of Larvae Taken**

**Regular CalCOFI Stations (Lines 10 to 157)**

*Neuston net hauls.* The neuston net at stations of

the regular CalCOFI grid caught 7,031 larvae-juveniles belonging to 51 categories (Table 2). Of these, two were Clupeiformes, three Stomiatoidei, 10 Myctophidae, three Scomberesocidae-Exocoetidae, six Scorpaeniformes, four Pleuronectiformes, 16 Perciformes, and seven others. Absent from the neuston collections were larvae of Argentinoidae, Myctophiformes other than Myctophidae, and Melamphaidae. Taken exclusively in the neuston hauls were larvae-juveniles of *Anoplopoma fimbria* (468 specimens in seven hauls), *Macrorhamphosus gracilis* (43 specimens in seven hauls), and *Opisthonema* sp. (149 larvae in three hauls). The average number of larvae per haul was 67.0.

In the neuston hauls 10 categories (six species, four genera) contributed 91.4% of the total, as follows: *Engraulis mordax*, 43.3%; *Cololabis saira*, 15.6%; *Oxyporhampus micropterus*, 11.2%; *Anoplopoma fimbria*, 6.7%; *Tarletonbeania crenularis*, 4.2%; *Oligoplites* sp. 3.6%; *Opisthonema* sp., 2.1%; *Sebastes* sp., 1.9%; *Vinciguerria lucetia*, 1.9%, and *Auxis* sp., 0.9%.

*Oblique net hauls.* Almost 2.5 times as many kinds of larvae were taken in the oblique hauls as in neuston hauls made over the regular CalCOFI grid of stations; 123 categories as compared to 51 (Table 2). The breakdown of the kinds of larvae taken in regular hauls was as follows: two Clupeiformes, 10 Argentinoidae, 10 Stomiatoidei, 26 Myctophidae, 12 other Myctophiformes, five Anguilliformes, three Scomberesocidae-Exocoetidae, five Gadiformes, three Melamphaidae, 12 Pleuronectiformes, seven Scorpaeniformes, 22 Perciformes, and six others. The average number of larvae per haul was 188.8.

In the oblique hauls, 10 categories (eight species, two genera) contributed 87.1% of the larvae obtained, as follows: *Engraulis mordax*, 53.8%;

TABLE 2  
 Comparisons of Catches of Neuston Net and Oblique CalCOFI Net at 105 Stations Over  
 the Regular CalCOFI Pattern on Cruise 7205

	Neuston				Oblique			
	Occurrences	Number Specimens	Stage	Size Range (mm)	Occurrences	Number Specimens	Stage	Size Range (mm)
Clupeidae:								
<i>Opisthonema</i> sp. ....	3	149	L	3.0-15.0	0	0	--	0
Engraulidae:								
<i>Engraulis mordax</i> .....	25	3,041	L	2.5-31.0	36	10,671	L	2.0-20.5
Bathylagidae:								
<i>Leuroglossus stilbius</i> .....	0	0	--	--	20	128	L-J	2.3-19.0
<i>Bathylagus nigrigenys</i> .....	0	0	--	--	8	45	L	2.5-10.0
<i>Bathylagus ochotensis</i> .....	0	0	--	--	25	70	L-J	4.9-27.5
<i>Bathylagus wesethi</i> .....	0	0	--	--	15	189	L	2.5-18.0
Sternopterychiidae:								
<i>Cyclothone</i> spp. ....	0	0	--	--	12	68	L	3.3-13.5
<i>Vinciguerria lucetia</i> .....	7	136	L	2.0-15.5	35	3,162	L	2.0-19.0
Myctophidae:								
<i>Ceratoscopelus townsendi</i> .....	0	0	--	--	10	90	L	2.0-12.0
<i>Diaphus</i> spp. ....	2	4	L	4.2- 5.2	14	79	L	2.5- 6.6
.....		1	L	5.8				
<i>Diogenichthys laternatus</i> .....	2	1	J-A	19.5	7	673	L	1.8-10.4
<i>Goniichthys tenuiculum</i> .....	11	41	J-A	14.5-57.5	9	48	L	2.0- 6.7
<i>Hypogomphus atratum</i> .....	4	50	J-A	14.5-57.5	16	123	L	1.8-13.5
<i>Lampadena urophaos</i> .....	2	17	L	5.0- 6.5	4	18	L	2.9- 8.9
<i>Lampanyctus</i> spp. ....	1	2	L	3.4, 4.0	60	222	L	2.0-14.0
<i>Myctophum nitidulum</i> .....	1	1	J-A	35.0	1	1	L	4.0
<i>Protomyctophum crockeri</i> .....	0	0	--	--	40	102	L	2.5-19.0
<i>Stenobrachius leucopsarus</i> .....	3	4	L	3.5-13.2	40	277	L	2.5-14.0
<i>Symbolophorus californiensis</i> .....	3	3	J-A	39.5-71.0	14	81	L	2.9-12.5
<i>Tarletonbeania crenularis</i> .....	12	296	J-A	20.5-67.0	31	130	L	3.3-18.0
<i>Triphoturus mexicanus</i> .....	0	0	--	--	37	355	L	1.5- 9.4
Other myctophids incl unident. ....	4	5	--	--	9*	128	--	--
Scomberesocidae:								
<i>Cololabis saira</i> .....	49	1,095	L-J	5.0-57.0	5	8	L	5.6-14.0
Exocoetidae:								
<i>Oxyporhamphus micropterus</i> .....	8	785	L	3.5-15.0	3	6	L	4.3- 6.5
Others .....	12	107	L-J	3.2-20.5	0	0	--	--
Merlucciidae:								
<i>Merluccius productus</i> .....	2	2	L	4.0, 14.5	15	75	L	2.0-16.5
Bregmacerotidae:								
<i>Bregmaceros bathymaster</i> .....	1	7	L	2.3- 4.0	6	957	L	2.4-11.5
Melamphidae:								
<i>Melamphaes</i> spp. ....	0	0	--	--	22	44	L	2.4-20.5
Macrorhamphosidae:								
<i>Macrorhamphosus gracilis</i> .....	4	43	L-J	8.0-25.5	0	0	--	--
Sphyraenidae:								
<i>Sphyraena</i> sp. ....	1	31	L	2.5- 5.0	1	119	L	2.3- 4.9
Polynemidae:								
<i>Polydactylus</i> sp. ....	1	13	L	4.0-13.5	1	5	L	2.0- 3.0
Mugilidae:								
<i>Mugil</i> sp. ....	7	53	L-J	3.5-19.0	1	1	L-J	19.0
Carangidae:								
<i>Trachurus symmetricus</i> .....	5	43	L	2.5- 3.5	20	450	L	1.5-15.0
<i>Oligoplites</i> sp. ....	1	253	L	3.0- 8.5	1	15	L	2.8- 4.3
Coryphaenidae:								
<i>Coryphaena</i> sp. ....	3	3	L	4.2-15.0	2	4	L	3.0- 5.2
Scombridae:								
<i>Auzis</i> sp. ....	3	60	L	2.5-11.0	5	93	L	2.0- 5.9
Blenniidae:								
<i>Hypsoblennius</i> sp. ....	4	6	L	6.6-12.0	1	1	L	3.4
Scorpaenidae:								
<i>Sebastes</i> spp. ....	15	137	L-J	3.0-33.5	37	307	L-J	3.1-17.0
Cottidae:								
<i>Scorpaenichthys marmoratus</i> .....	2	6	L	7.0-11.0	0	0	--	--
Anoplopomatidae:								
<i>Anoplopoma fimbria</i> .....	7	468	L	9.0-32.5	0	0	--	--
Hexagrammidae:								
<i>Hexagrammos</i> sp. ....	4	5	L-J	12.0-31.0	0	0	--	--
<i>Oxylebius pictus</i> .....	2	4	L	2.7- 8.9	0	0	--	--
Pleuronectidae:								
<i>Pleuronichthys</i> sp. ....	2	3	L	5.8- 9.0	3	3	L	2.6- 7.0
Bothidae:								
<i>Citharichthys</i> sp. ....	3	3	L	3.2- 5.1	8	36	L	2.5-33.5
<i>Paralichthys californicus</i> .....	2	2	L	7.8, 7.9	1	5	L	2.2- 2.9
Other identified: .....	18	102	--	--	89*	640	--	--
Unidentified: .....	5	36	--	--	--	304	--	--
Disintegrated: .....	6	13	--	--	--	88	--	--
TOTAL .....	105	7,031	--	--	105	19,823	--	--

\* Indicates number of categories included rather than number of occurrences.



TABLE 3  
Comparison of Catches of Neuston Net and Oblique CalCOFI Net at 43 Stations  
Spaced Along Six Offshore Latitudinal Lines on Cruise 7205.

	Neuston				Oblique			
	Occurrences	Number Specimens	Stage	Size Range (mm)	Occurrences	Number Specimens	Stage	Size Range (mm)
Bathylagidae:								
<i>Bathylagus</i> spp. ....	0	0	--	--	13	50	L	3.7-18.5
Sternoptychidae:								
<i>Cyclothone</i> spp. ....	2	3	L	2.0- 6.5	32	232	L	2.0-16.0
<i>Diplophos taenia</i> .....	1	1	L	6.0	6	8	L	4.8-43.5
<i>Sternoptyx</i> sp. ....	0	0	--	--	23	157	L	2.1- 9.6
<i>Vinciguerria</i> spp. ....	3	6	L; J-A	7.0-40.0	27	823	L	2.1-19.5
Other .....	0	0	--	--	10*	107	--	--
Malacosteidae:								
<i>Aristostomias</i> sp. ....	3	7	L	17.5-42.0	4	8	L	6.1-27.5
Melanostomidae:								
<i>Bathophilus</i> sp. ....	5	7	L	4.0-28.0	5	6	L	4.4-26.0
<i>Eustomias</i> sp. ....	2	2	L	6.0-16.0	0	0	--	--
Stomiatoidei:								
Other .....	0	0	--	--	8	91	--	--
Myctophidae:								
<i>Bolinichthys</i> sp. ....	6	38	L	4.3-12.0	9	22	L	2.7- 8.9
<i>Ceratoscopelus</i> spp. ....	5	46	L	3.2-15.0	30	567	L	1.8-17.0
<i>Diaphus</i> spp. ....	1	1	L	3.7	17	54	L	2.3- 9.2
<i>Diogenichthys</i> spp. ....	0	0	--	--	25	250	L	2.0-11.0
<i>Electrona rissoi</i> .....	0	0	--	--	12	37	L	2.6- 7.5
<i>Gonichthys tenuiculus</i> .....	2	5	J-A	23.5-46.0	0	0	--	--
<i>Hygophum</i> spp. ....	1	6	J-A	13.5-22.0	20	84	L	2.4-11.5
<i>Lampadena urophaos</i> .....	7	144	L	3.5-17.0	16	63	L	2.2-12.5
<i>Lampanyctus</i> spp. ....	5	6	L	3.5-13.5	36	238	L	2.0- 8.0
<i>Loveina rara</i> .....	1	1	J-A	24.0	5	7	L	2.9- 8.6
<i>Myctophum nitidulum</i> .....	1	1	J-A	20.0	18	41	L	2.3- 9.6
<i>Notolychnus valdiviae</i> .....	0	0	--	--	19	90	L	2.0- 8.7
<i>Notoscopelus resplendens</i> .....	0	0	--	--	17	86	L	2.3-15.5
<i>Protomyctophum</i> spp. ....	0	0	--	--	13	35	L	2.5-17.2
<i>Symbolophorus</i> spp. ....	0	0	--	--	20	77	L	3.2-15.5
<i>Stenobrachius leucopsarus</i> .....	2	2	L	3.4, 10.0	8	95	L	3.0- 9.0
<i>Taaningichthys minimus</i> .....	14	142	L	4.5-20.0	3	3	L	4.7- 9.4
<i>Tarletonbeania crenularis</i> .....	0	0	--	--	8	29	L	5.0-18.0
<i>Triphoturus</i> spp. ....	0	0	--	--	9	34	L	2.9-11.6
Other .....	4	10	L, J	3.0-16.5	9*	78	L	2.5-12.0
Paralepididae:								
Several kinds .....	0	0	--	--	25	49	L	3.0-45.0
Scopelarchidae:								
<i>Scopelarchus</i> spp. ....	0	0	--	--	12	24	L	3.8-29.0
Scomberesocidae:								
<i>Cololabis saira</i> .....	25	347	L-J	4.5-71.0	1	1	J-A	82.0
<i>Cololabis adocetus</i> .....	6	158	L-J	4.6-49.0	0	0	--	--
Exocoetidae:								
Several kinds .....	12	64	L-J	4.0-20.5	0	0	--	--
Bregmocerotidae:								
<i>Bregmaceros</i> spp. ....	0	0	--	--	12	39	L	1.9-19.2
Melamphaidae:								
Several kinds .....	0	0	--	--	26	88	L	1.8-17.0
Percichthyidae:								
<i>Hovella</i> sp. ....	0	0	--	--	7	25	L	2.3- 4.1
Bramidae:								
<i>Brama japonica</i> .....	0	0	--	--	4	9	L	3.0- 6.4
Coryphaenidae:								
<i>Coryphaena</i> sp. ....	2	2	L	11.0-18.0	1	1	L	4.3
Gempylidae--Trichiuridae:								
Several kinds .....	0	0	--	--	13	19	L	2.1-17.5
Carangidae:								
<i>Trachurus symmetricus</i> .....	1	18	L	1.7- 3.5	5	62	L	2.0- 4.5
<i>Naucrates ductor</i> .....	2	2	L	9.5, 10.5	0	0	--	--
Scorpaenidae:								
<i>Sebastes</i> spp. ....	1	1	L	12.0	1	4	L	7.0-11.5
Ceratiodei:								
Five families .....	0	0	--	--	5*	10	L	2.2- 5.0
Other identified .....	0	0	--	--	20*	44	--	--
Unidentified .....	3	3	--	--	27	92	--	--
Disintegrated .....	3	4	--	--	21	59	--	--
TOTAL .....	43	1,027			43	3,899		

\* Indicates number of categories included rather than number of occurrences.

*Vinciguerria lucetia*, 16.0%; *Bregmaceros bathymaster*, 4.8%; *Diogenichthys laternatus*, 3.4%; *Trachurus symmetricus*, 2.3%; *Triphoturus mexicanus*, 1.8%; *Sebastes* spp., 1.5%; *Stenobranchius leucopsarus*, 1.4%; *Lampanyctus* spp., 1.1%; and *Bathylagus wesethi*, 1.0%.

#### Offshore Latitudinal Lines

**Neuston net hauls.** In the offshore collections, only 24 kinds of larvae-juveniles were taken in the neuston net hauls (Table 3); of these five were Stomiatoidei, 11 Myctophidae, three Scomberesocidae-Exocoetidae, one Scorpaeniformes (*Sebastes* sp.), and three Perciformes (*Trachurus symmetricus*, *Naucrates ductor*, and *Coryphaena* sp.). The catches were dominated by larvae-juveniles of Scomberesocidae-Exocoetidae and larvae of Myctophidae, which combined contributed 94.5% of the specimens. Two scomberesocids and four myctophids contributed 85.2% of the total, as follows: *Cololabis saira*, 33.8%; *C. adocetus*, 15.4%; *Lampadena urophaos*, 14.0%; *Taaningichthys minimus*, 13.8%; *Ceratoscopelus* sp. (*townsendi*-complex), 4.5%; and *Bolinichthys* sp., 3.7%. The average number of larvae per haul was 23.9.

**Oblique net hauls.** Markedly more kinds of fish larvae were taken in the oblique plankton hauls made on the offshore latitudinal lines. They were grouped into 85 categories, of which 16 were Stomiatoidei, five Argentinoidei, 24 Myctophidae, 11 other Myctophiformes, four Melamphaidae, 11 oceanic Perciformes, five Ceratiodei, and nine others. The absence of some of these groups from neuston collections, such as the Argentinoidei was anticipated since the larvae were known to occur in or below the thermocline. However, the complete absence from neuston hauls of all myctophiform groups except Myctophidae was not anticipated. Among the myctophiform groups not sampled by the neuston net are the Paralepididae, Scopelarchidae, Scopelosauridae, and Evermannellidae. In the oblique hauls in the offshore area the Myctophidae contributed 48.5%; the Stomiatoidei, 36.7%; Argentinoidei, 1.4%; other Myctophiformes, 2.2%; Melamphaidae, 2.3%; oceanic Perciformes, 3.2%; and all others, 5.7%. The average number of larvae per haul was 90.7.

#### SPECIES

Inasmuch as we know a great deal about the kinds of larvae taken in our oblique hauls, and very little about the catches from surface neuston nets, we plan to orientate our discussions to the latter. The species or groups we will discuss in some detail are the following: northern anchovy, *Engraulis mordax*, eggs and larvae; Pacific saury, *Cololabis saira*, eggs and larvae-juveniles; jack mackerel, *Trachurus symmetricus*, eggs and larvae; sablefish, *Anoplopoma fimbria*, larvae; rockfish, *Sebastes* spp., larvae;

slender snipefish, *Macrorhamphosus gracilis*, larvae-juveniles; myctophid lanternfishes, larvae-juveniles.

#### Anchovy (Eggs and Larvae), *Engraulis mordax* Girard

Anchovy eggs were taken in 13 neuston net hauls and in 17 oblique plankton hauls at comparable stations (Figure 2). However, the total number of eggs collected was greater in the neuston hauls; 4,529 as compared to 2,741. Studies on vertical distribution of anchovy eggs (Ahlstrom, 1959; Ahlstrom et al., 1958) indicated a variable depth distribution within the upper mixed layer from haul-to-haul, sometimes with largest concentrations near the surface, sometimes not.

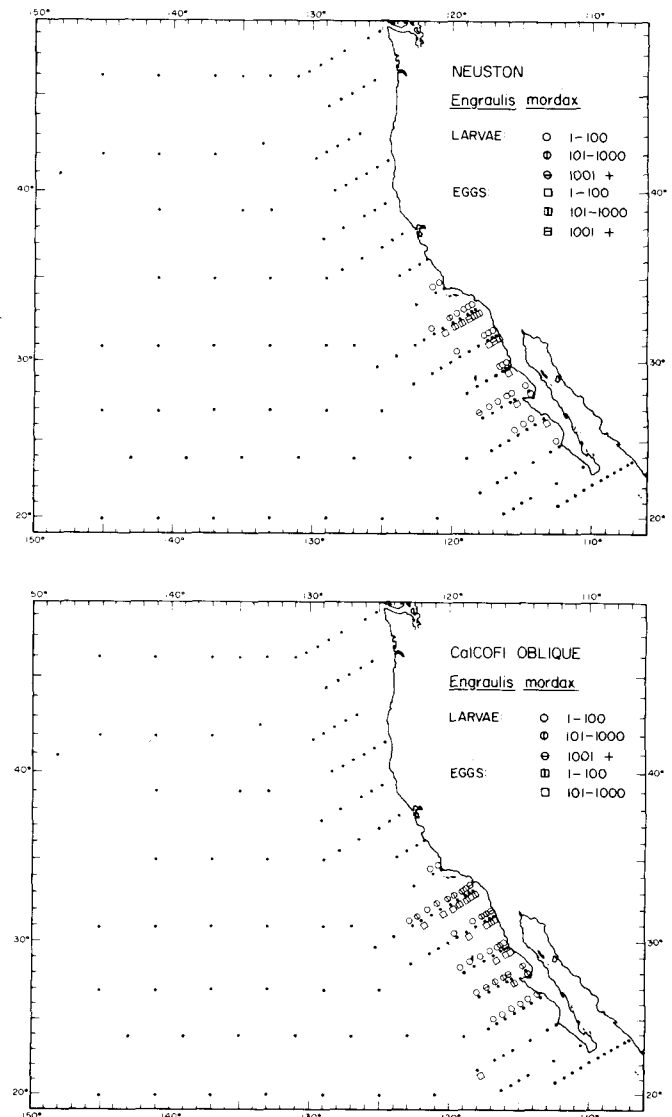

FIGURE 2. Distribution and relative abundance of eggs and larvae of the northern anchovy, *Engraulis mordax*, taken in neuston hauls (upper) and CalCOFI oblique hauls (lower) on Cruise 7205.

We have made two simple assumptions to facilitate comparison of numbers of eggs taken in the two types of hauls, both using 505 micra meshes. First we assumed that the neuston haul strained approximately 30% as much water as the standard oblique haul, and second that anchovy eggs were distributed between the surface and 60 m deep, hence for the oblique hauls which averaged approximately 200 m depth, the net was in water containing anchovy eggs during 30% of the time duration of the haul. If these assumptions are acceptable, the original counts from the two nets should be roughly comparable. The comparisons indicate higher concentrations of eggs near the surface in better than half of the hauls containing 40 or more eggs in either net.

Anchovy larvae were taken in 25 neuston net collections; they were obtained in oblique net hauls made at all of these stations, and at 11 additional stations on which both types of hauls were taken.

As indicated above, it was estimated that the neuston net strained approximately 30% as much water as the obliquely drawn net. The neuston net

also collected about 30% as many anchovy larvae as the oblique net. However, anchovy larvae were probably collected during 30% to 50% of the time duration of the oblique haul, because they were seldom deeper than 100 m and usually shallower. Hence, less larvae were taken by the neuston net per unit volume of water strained than by the oblique net while sampling the depth stratum over which anchovy larvae were distributed.

A different segment of the anchovy larvae population was sampled at the surface in neuston net hauls than in the complete depth distribution of anchovy larvae sampled by the oblique plankton hauls (Table 4). Only about 2.5% as many small larvae, 2.0 to 6.0 mm, were taken in neuston hauls as in oblique plankton hauls. Conversely, only 2.5% as many large larvae, 14.5 mm and larger, were taken in the oblique hauls as in the neuston net hauls. These are striking differences. Obviously, larger anchovy larvae tend to congregate in the surface layer. The oblique net collected more larvae of all size categories between 2.0 and 10.0 mm, whereas the neuston net collected more larvae of all size categories, 10.5 mm and longer (Figure 3).

TABLE 4

Extended Cruise 7205, Anchovy Larvae, by Size Category, Taken in Neuston Net Hauls and Regular Plankton Hauls at the Same Stations

Size Category	Neuston	Regular Plankton
2.0	0	88
2.5	1	529
3.0	11	1809
3.5	15	1242
4.0	29	851
4.5	29	598
5.0	41	516
5.5	21	419
6.0	15	437
6.5	32	345
7.0	45	422
7.5	58	349
8.0	131	559
8.5	139	424
9.0	227	402
9.5	171	231
10.0	186	235
10.5	182	152
11.0	182	99
11.5	210	57
12.0	178	39
12.5	159	26
13.0	170	16
13.5	120	12
14.0	118	8
14.5	108	1
15.0	75	5
15.5	67	1
16.0	51	1
16.5	33	
17.25	58	2
18.25	37	1
19.25	27	1
20.25	11	
21.25	5	
22.25	2	
23.25	3	
24.25	4	
--		
28.25	1	
--		
31.25	1	
Dis.	88	788
Total	3,041	10,665

Pacific Saury (Eggs and Larvae), *Cololabis saira* (Brevoort)

The eggs of the Pacific saury are irregularly ovoid in shape, with a cluster of attachment filaments at one pole and a single median filament. The eggs often are found attached to cables or ropes of gear left suspended in the water (i.e. drogues, buoys, nets, etc.). The eggs are sometimes found attached to larger invertebrates, especially salps.

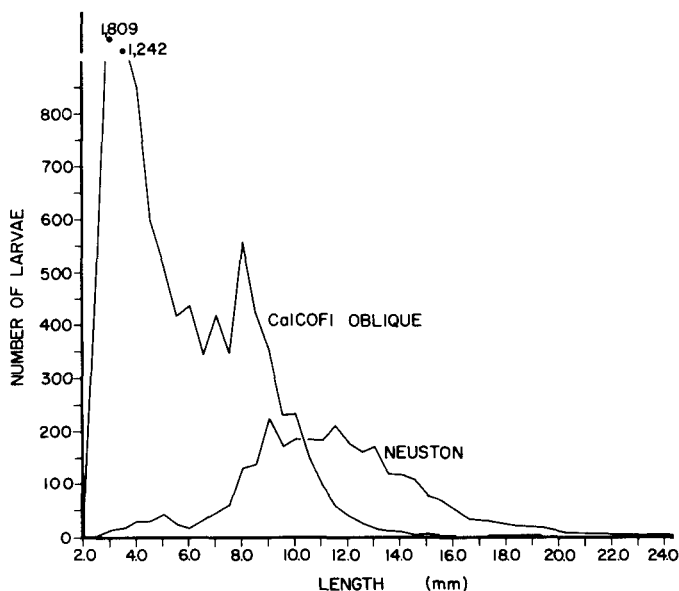

FIGURE 3. Size composition of larvae of northern anchovy, *Engraulis mordax*, in neuston collections versus CalCOFI oblique collections for all stations occupied in Cruise 7205.

The saury egg develops slowly; we lack precise information on rate of development as related to temperature, but it is about 10 days at room temperature for eggs kept in a finger bowl (Smith, Ahlstrom and Casey, 1970).

Despite the fact that saury eggs are spawned in large clusters, the eggs tend to fragment into small clusters (two to 10 eggs) or into individual eggs. Most saury eggs taken in plankton hauls are either individually separate or in small clusters.

Saury eggs were taken in 15 neuston net hauls, all from the regular CalCOFI pattern. Six of the hauls contained a single egg, seven hauls contained two to 10 eggs, one haul had 89 eggs, and one haul contained a very large group of approximately 3,000 eggs. The latter is one of the larger clusters of saury eggs that has been taken in a net haul. Only a single stage of development was observed in the eggs examined

from this cluster, and similarly for the sample containing 89 eggs. In two of the samples with small numbers of eggs, two developmental stages were represented, hence these contained eggs spawned on two different nights.

Saury eggs were taken in 18 oblique net hauls of which 16 were from the regular CalCOFI grid and two from offshore (Figure 4). No collections contained more than seven eggs and 11 collections contained but a single egg, hence large clusters of eggs were lacking. Of the seven collections with two or more eggs, four contained eggs with two stages of development, representing two days' spawning.

Saury eggs appear to be equally well (or poorly) collected by both types of gear; approximately 10% of the neuston hauls contained saury eggs, compared to circa 12% for oblique hauls.

Saury larvae-juveniles present quite a different picture. Larvae-juveniles of saury were taken in 74 of the 148 stations occupied with neuston gear on Cruise 7205, i.e., in 50% of the stations occupied; whereas these stages were obtained in only six oblique hauls, i.e., in 4% of the stations occupied. This is a dramatic difference.

Sampling with the neuston gear is even better than one would conclude from the above figure of 50% positive hauls. In the northern part of the survey pattern it was too early in the year for full saury spawning—rather spawning was just commencing in the waters off Washington and Oregon. Likewise, in the southern part of the pattern, particularly inshore off southern Baja California, we did not get saury spawning because this was beyond the southern limit of saury spawning. In the intermediate area—off northern Baja California and southern California, sauries were sampled at most stations occupied.

In addition to Pacific saury, *Cololabis saira*, there is a small tropical saury, *C. adocetus* Bohlke, in the eastern North Pacific. The dwarf species was taken at all stations occupied between 20.125 to 20.145 inclusive on the southernmost offshore line along 20° N latitude. The best method of distinguishing between these two species is by number of vertebrae. Specimens of *C. adocetus* had 56 to 58 vertebrae in contrast to those of *C. saira* which had 63 to 68. The young stages of the two species are remarkably similar in appearance otherwise. The caudal peduncle character given by Ueyanagi and Doi (1971) for distinguishing between specimens of the two species could not be consistently applied to our specimens. The positioning of the last finlet of the dorsal and anal fins in relation to the caudal fin was too similar on some specimens of both species to be a reliable character. Hence we relied on vertebrae counts made from radiographs for positive identifications.

Obviously the neuston net is a highly effective gear for sampling larvae-juveniles of saury, which live exclusively near the surface. The distributional pattern we obtained from neuston hauls on extended

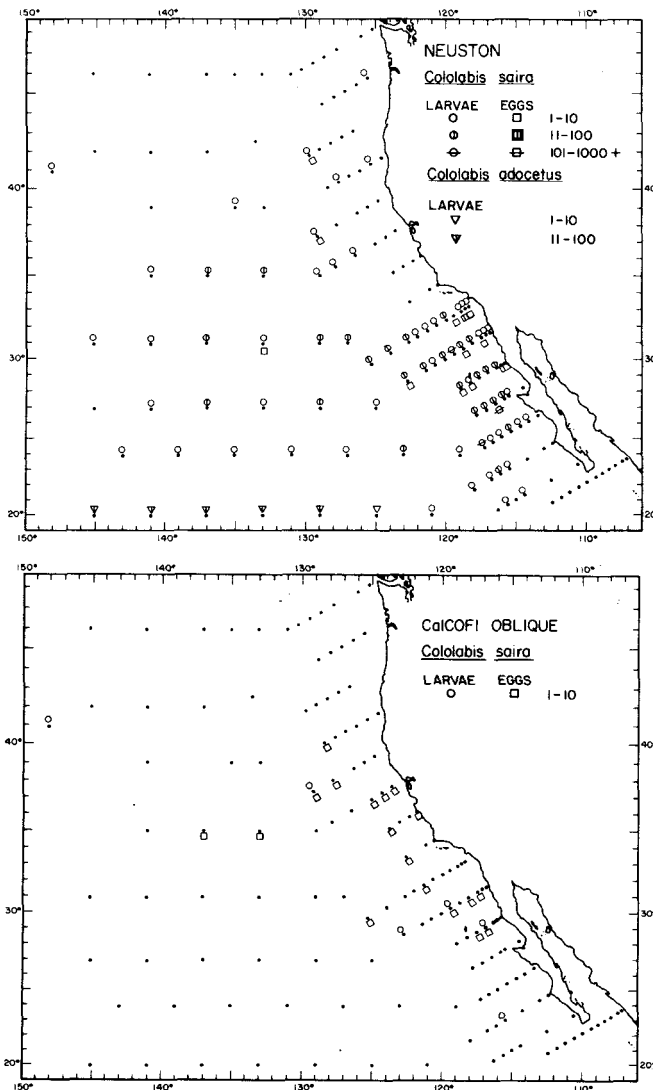

FIGURE 4. Distribution and relative abundance of eggs and larvae of Pacific saury, *Cololabis saira*, taken in neuston hauls (upper) and CalCOFI oblique hauls (lower). Larvae of *Cololabis adocetus* taken only in neuston hauls (upper) on Cruise 7205.

Cruise 7205, including the sharp separation of the two species of *Cololabis*, was much better than the composite pattern based on positive hauls for saury larvae-juveniles from all previous offshore CalCOFI cruises.

**Jack Mackerel (Eggs and Larvae), *Trachurus symmetricus* (Ayres)**

The offshore distribution of eggs and larvae of the jack mackerel, *Trachurus symmetricus*, was seldom completely circumscribed on our regular CalCOFI cruises (Ahlstrom, 1969). One of the objectives of extended Cruise 7205 was to obtain information on the offshore distribution of eggs and larvae of this species. Farris (1961) showed that May was usually the peak month for eggs and June for larvae of *Trachurus symmetricus*.

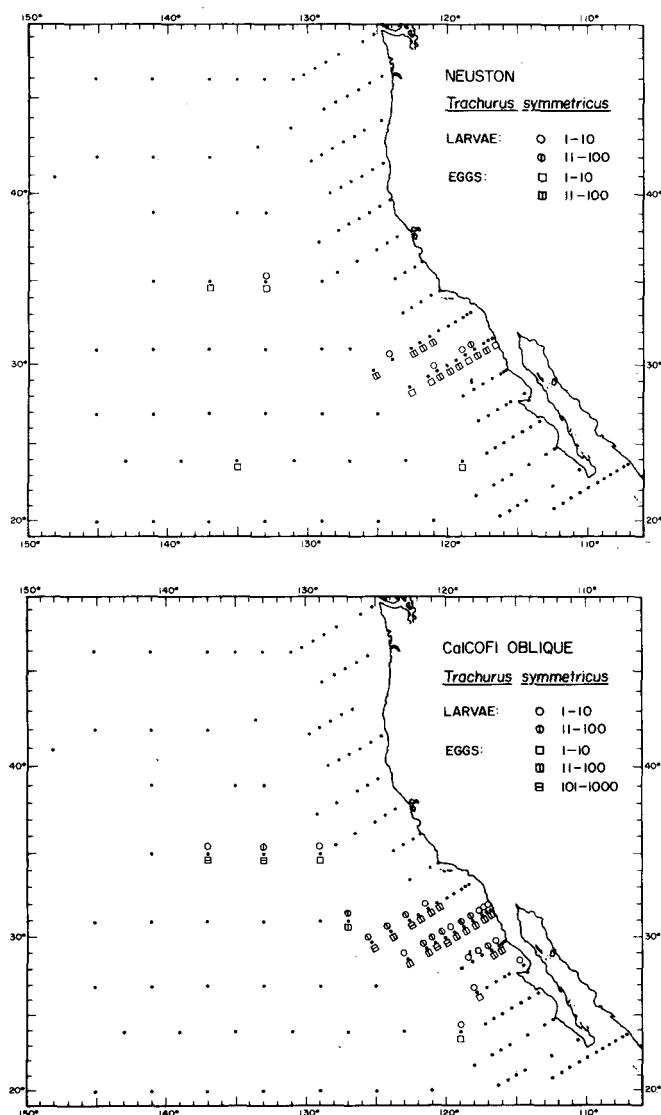

FIGURE 5. Distribution and relative abundance of eggs and larvae of jack mackerel, *Trachurus symmetricus*, taken in neuston hauls (upper) and CalCOFI oblique hauls (lower).

Although jack mackerel eggs and larvae were taken in both types of plankton hauls (Figure 5), the eggs and larvae occurred in more oblique hauls than in neuston net hauls. This was particularly true of the larvae; jack mackerel larvae were taken in only six neuston net hauls as compared to 25 oblique hauls. Moreover, only small jack mackerel larvae, 1.7 to 3.5 mm, were taken in the neuston collections; whereas, larvae up to 15.0 mm were taken in the oblique hauls. Hence, larger larvae of jack mackerel do not congregate near the surface as do those of the northern anchovy. Jack mackerel eggs, however, are collected relatively well in surface neuston hauls—occurring in 16 hauls as compared to 23 oblique hauls. Jack mackerel eggs previously had been found in some abundance near the surface (Ahlstrom, 1959; Bieri, 1961), hence their presence in the neuston net hauls was not unexpected.

**Sablefish (Larvae), *Anoplopoma fimbria* (Pallas)**

Larvae of the sablefish were taken in seven collections with most specimens taken at station 20.20 (Figure 6). A size series of 443 specimens, 9.0 to 33.0 mm, was obtained at this station. No specimens of sablefish larvae were taken in oblique plankton hauls on Cruise 7205. The large collection of sablefish from station 20.20 contained more specimens than the aggregate of all specimens collected previously in oblique hauls on CalCOFI cruises. A complete size series was available from this one haul—which we have used for illustrations (Figure 7). The larvae are slender, heavily pigmented and develop strikingly large, but distinctively pigmented pectoral fins. Brock (1940) called attention to the large pigmented pectoral fins, one-third the standard length, that

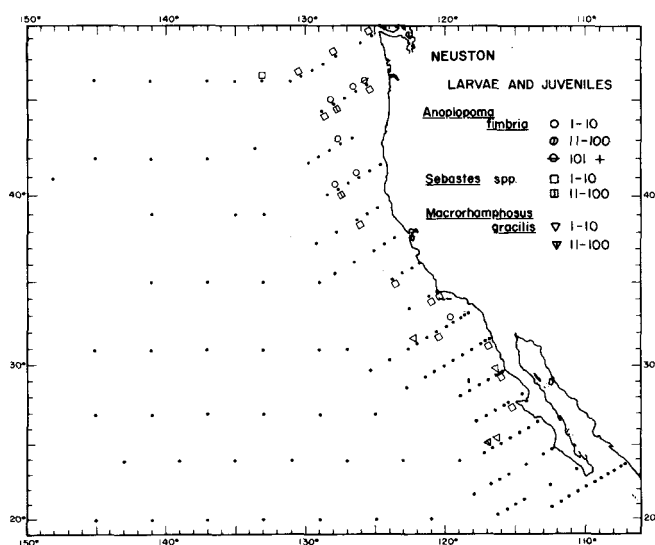

FIGURE 6. Distribution and relative abundance of larvae and early juveniles of the sablefish, *Anoplopoma fimbria*; rockfishes, *Sebastes* spp.; and slender snipefish, *Macrorhamphosus gracilis*, in neuston collections on Cruise 7205.

ANOPOLOPOMA FIMBRIA

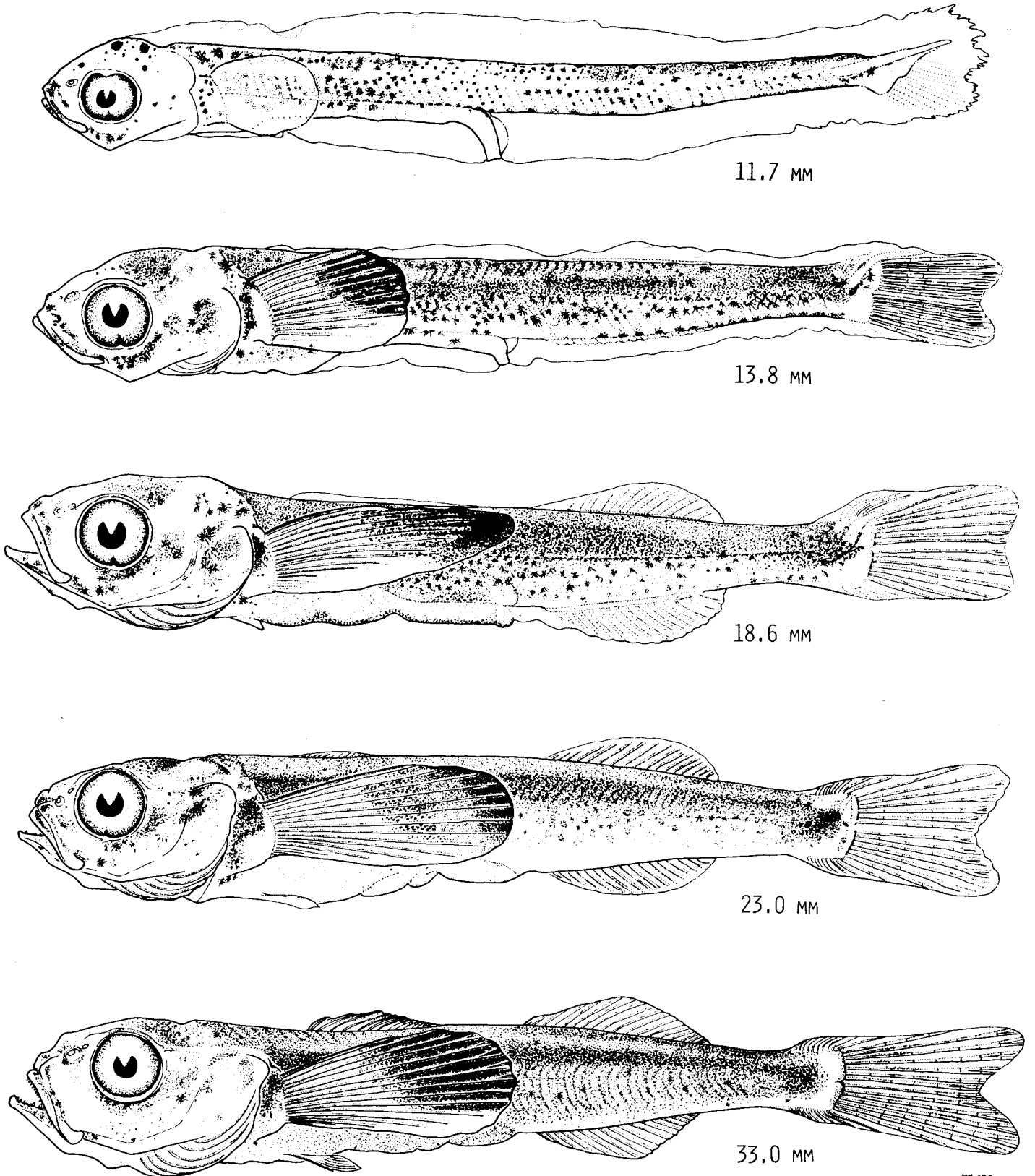

FIGURE 7. Larval developmental series of sablefish, *Anoplopoma fimbria*, based on neuston collections made at CalCOFI station 7205-20.20. Measurement given under figures are standard length.

F. M. ORR

develop on late-stage larvae of sablefish. Kobayashi (1957) described a larval series, with illustrations of five specimens, 11.3 to 30.2 mm total length. Our specimens are similarly shaped, but more heavily pigmented on the back and particularly more heavily pigmented on the outer margins of the pectoral fins.

#### Rockfish (Larvae), *Sebastes* spp.

Rockfish larvae were taken in 16 neuston collections (Figure 5). The two largest collections were obtained at stations 20.50 (60 specimens 8.5 to 15.0 mm) and 40.80 (48 specimens 14.5 to 31.0 mm). The latter collection, especially, contained larger sized specimens, seldom obtained in oblique plankton hauls. Rockfish larvae were taken in 38 oblique plankton hauls; the number of specimens per collection ranged from one to 55. The difference in size composition of the specimens taken by the two types of gear is quite dramatic. Of the 138 specimens taken in neuston collections, only 16 were 10.0 mm or less in standard length, 78 were in the size range of 10.1 to 20.0 mm, and 44 were 20.1 to 33.5 mm. In contrast, 298 of the 308 specimens taken in oblique hauls were 10.0 mm or less in body length and only 10 specimens were larger than 10.0 mm, i.e., 10.1 to 17.0 mm. Obviously larger size specimens of rockfish still in the pelagic stage do tend to congregate at the surface. Most rockfish in the neuston hauls appear to be a single species; although specimens could not be identified with certainty, *Sebastes alatus* is a possibility.

#### Slender Snipefish (Larvae-Juveniles), *Macrorhamphosus gracilis* (Lowe)

Larvae of this species are occasionally taken in CalCOFI collections. Specimens were obtained in four neuston collections (Figure 5); with most specimens in the collection taken at station 130.80, where 38 specimens ranging in length from 8.0 to 17.5 mm were caught. This is another instance in which the neuston collections contained both more specimens and larger sizes than were taken in oblique hauls. As Fitch and Lavenberg (1968) recorded, this species is a schooling fish usually occurring in small schools of 50 to 100 individuals, but on one occasion off southern California, fishermen set on a school estimated to contain 40 to 50 tons. No material of this species was obtained in the oblique plankton hauls made on extended Cruise 7205.

#### Family Myctophidae

The early developmental stages of myctophids are sharply separable into two groups, those that have narrow-eyed larvae and those that have round-eyed larvae. The myctophids in the first group belong to the subfamily Myctophinae, those in the second group to the subfamily Lampanyctinae (Paxton, 1972; Moser and Ahlstrom, 1972, 1974).

The family Myctophidae was well represented in

neuston net collections, inasmuch as larvae and/or juvenile-adults were obtained for 15 genera—eight in the subfamily Myctophinae, seven in the subfamily Lampanyctinae. Equal numbers of specimens were obtained of each subfamily in neuston hauls, 407 as compared to 407. What was completely unanticipated was that all specimens except one of Myctophinae taken in neuston hauls were juvenile-adults, whereas all specimens of Lampanyctinae were exclusively larvae.

#### Subfamily Myctophinae

As noted above, all specimens of this subfamily taken in surface neuston collections, save for one larva, were juvenile-adults, including recently transformed specimens, belonging to eight genera. In contrast, the collections of this subfamily from oblique plankton hauls contained only larvae, save for one juvenile of *Diogenichthys atlanticus*. Larval material was obtained of the eight genera sampled in neuston hauls, and of two additional genera (*Protomyctophum* and *Electrona*). Hence, for members of this subfamily the two types of gear sampled different developmental stages.

Most material of this subfamily in neuston collections was obtained over the regular CalCOFI grid—393 of 407 specimens. In contrast, larvae of this subfamily were slightly more abundant in the offshore grid of stations in oblique plankton hauls, the average number per collection was 14 in the offshore grid, 12 over the regular CalCOFI grid.

The several kinds of juvenile-adult myctophids of the subfamily Myctophinae taken in neuston net hauls belong to species that commonly have been dipnetted under working lights of our research vessels while on station.

The four genera of myctophids known collectively as the slendertails are among the lanternfishes that are known to occur at the surface. The most common species of slendertails in the neuston net hauls was *Tarletonbeania crenularis* (Figure 8, upper); 296 specimens, 20.5 to 67.0 mm standard length were obtained from 12 hauls, preponderantly from the northern part of the regular CalCOFI pattern, i.e. lines 10 to 30 off Washington and Oregon. Its southern counterpart, *Gonichthys tenuiculus*, was taken in 13 collections from the southern part of the CalCOFI pattern, but in lesser abundance (Figure 8, upper), 46 specimens total, 14.5 to 57.5 mm standard length. Only single specimens of early juveniles were obtained of the other two genera of slendertails, a 24.0 mm specimen of *Loweina rara*, and a 16.5 mm specimen of *Centrobranchus choerocephalus*.

Among other Myctophinae lanternfishes only juveniles of *Hygophum atratum* were taken in any abundance in neuston hauls—56 specimens, 13.5 to 47.5 mm standard length from six stations off central and southern Baja California.

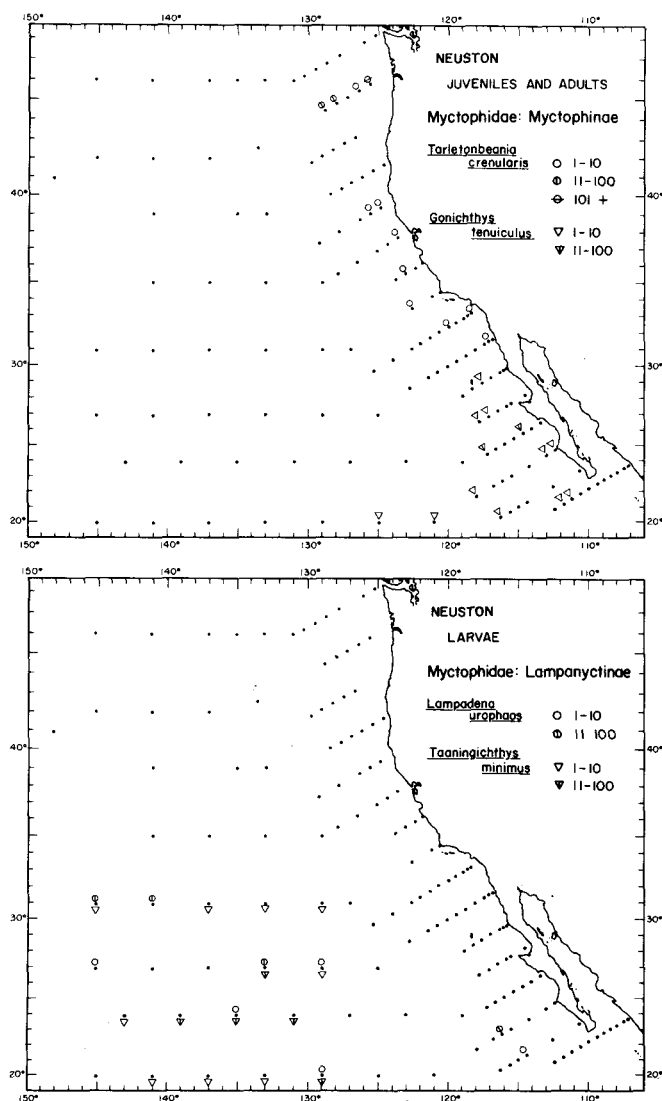

FIGURE 8. Upper—Distribution and relative abundance of juveniles and adults to two slender-tails, *Tarletonbeania crenularis* and *Gonichthys tenuiculus* (Family Myctophidae, Subfamily Myctophinae). Lower—Distribution and relative abundance of larvae of two lanternfishes *Lampadena urophaos* and *Taaningichthys minimus* (Family Myctophidae, Subfamily Lampanyctinae).

### Subfamily Lampanyctinae

Only larvae of lanternfishes of this subfamily, not juvenile-adults, were taken in neuston net hauls. The material from oblique plankton hauls consisted predominantly of larvae, together with a few juvenile-adult specimens. There is little relation between the kinds and relative abundance of myctophid larvae sampled by the two kinds of gear.

Only three kinds of lampanyctine larvae were taken at all commonly in neuston net hauls: *Taaningichthys minimus*, *Lampadena urophaos*, and *Bolinichthys* sp. In addition, four kinds were taken infrequently: *Ceratoscopelus* sp., *Diaphus* sp., *Lampanyctus* sp., and *Stenobranchius leucopsarus*.

Larvae of *T. minimus* furnish a prime example of

a species taken in markedly greater abundance in neuston collections. Larvae of this species, ranging from 4.0 to 20.0 mm long, were obtained at 14 neuston stations, averaging 10 larvae per positive haul (Figure 8, lower). In oblique plankton hauls a total of three specimens, 3.0 to 9.0 mm long, was obtained in as many hauls. It should be noted that the size range sampled in neuston hauls is from early stage larvae to larvae about ready to metamorphose, i.e., all sizes of larvae of this species occur in the surface layer sampled by the neuston net. Adults of this species occur predominantly at depths between 450 and 500 m, and do not appear to perform daily vertical migration (Davy, 1972). Even so, the adults probably do migrate to the upper mixed layer to spawn; otherwise there is no obvious mechanism for the larvae to get to the surface layer from the depths at which the adults live.

Larvae of *L. urophaos* and *Bolinichthys* sp. were taken in larger numbers per collection in neuston hauls, but occurred in more than twice as many oblique hauls as neuston. A total of 162 specimens of *L. urophaos* larvae was taken in nine neuston collections, an average of 18 specimens per positive haul (Figure 8, lower). Larvae of this species were taken in 20 oblique hauls, but in lesser abundance—averaging only four specimens per positive haul.

Larvae of *Bolinichthys* sp. were taken in 13 oblique hauls as compared to six neuston hauls; however, the latter yielded 38 larvae as compared to a total count of 28 for oblique hauls.

For all other categories of lampanyctine lanternfishes, the oblique hauls obtained decidedly more larvae in more collections. Several examples follow.

Larvae of *Ceratoscopelus* sp. were taken in five neuston hauls for a total count of 38, whereas larvae of *Ceratoscopelus* sp. occurred in 40 oblique hauls for a total count of 657.

Larvae of *Stenobranchius leucopsarus* were taken in five neuston hauls (total of six specimens) as compared to 48 oblique hauls in which 372 specimens were obtained. For the other two kinds of lampanyctine larvae taken in neuston hauls, *Diaphus* had three occurrences for a total of five specimens, and *Lampanyctus* had six occurrences for a total of eight as compared to 31 occurrences and 133 specimens of *Diaphus* and 96 occurrences and 460 specimens of *Lampanyctus* in oblique hauls.

Although larvae of *Triphoturus mexicanus* and *T. nigrescens* were not taken in neuston hauls, they occurred in 46 oblique hauls, contributing 460 specimens.

### DISCUSSION

Most kinds of fishes taken commonly in the CalCOFI neuston collections or species closely related to these have been taken in other areas in



neuston hauls (Hempel and Weikert, 1972; Nellen, 1973). For example, there is a striking similarity between the forms taken in neuston hauls in the vicinity of the Meteor Seamount in the eastern Atlantic (Nellen, 1973). The four most common kinds were *Scomberesox saurus*, the Atlantic equivalent of the Pacific saury, 57.3% of total; *Macrorhamphosus* sp., 36.2%; *Goniichthys cocco*, 3%; *Taaningichthys* sp., 0.6% for a composite total of 97.1%.

#### Advantages and Disadvantages of Neuston Net Collections

We propose to give a brief summary of the advantages and disadvantages of neuston net collections. For fishes that congregate near the surface at any stage in their early development—from eggs, larvae, to juvenile stages the neuston net is a good gear for establishing areal distribution and even relative abundance. For example, the distribution of the Pacific saury, based on neuston net hauls on Cruise 7205, provided a more coherent distributional pattern than was obtained from composite oblique plankton hauls records from a number of previous CalCOFI cruises. Furthermore, the distribution of the small tropical saury, *Cololabis adocetus*, could be sharply delimited from that of the Pacific saury, *C. saira*. The sablefish, *Anoplopoma fimbria*, was markedly more abundant in neuston net hauls and a larger size range of specimens was sampled than have been taken in oblique hauls. The lanternfish, *Taaningichthys minimus*, appears to prefer the surface layer at all stages of larval development.

For some kinds of fishes, larger sized specimens are taken in neuston hauls than in oblique hauls. A number of examples were given in the preceding discussions. For example, strikingly more larger anchovy larvae were taken in neuston hauls than in oblique; the size composition of rockfishes, *Sebastes* spp. taken by the two types of hauls also was markedly different, with larger sized specimens predominating in the neuston hauls. However, larvae of jack mackerel, *Trachurus symmetricus* proved an exception in that only small larvae were taken in neuston hauls, compared to a larger size range of larvae in oblique hauls. For some fishes, a different developmental stage was sampled by the neuston haul; thus, only juvenile-adult material of myctophine lanternfishes was taken in neuston hauls, whereas the complete size range of larvae of these lanternfishes was obtained in oblique hauls.

The marked difference in size composition of anchovy larvae in the neuston hauls as compared to standard oblique hauls points up the fact that the neuston hauls collect a disproportionate number of larger larvae while markedly undersampling the smaller sizes. What are the implications of these differences with regard to mortality estimates? A

first reaction is that the neuston sample is a highly biased one, of dubious value for mortality studies. But the neuston haul does provide a much larger sample of anchovy larvae in the size range of 14 mm and larger—sizes that are poorly sampled in oblique hauls. On reconsideration, why not take advantage of this fact. If additional work with neuston hauls shows that the larger sized larvae of anchovies are consistently sampled by the neuston net from station to station and cruise to cruise, then this net could be used to provide estimates of changes in relative abundance of larger anchovy larvae from year to year—information essential for evaluating success of survival of cohorts of anchovies.

Although some species are sampled more abundantly in neuston hauls, the reverse is also true. Many kinds of larvae common in oblique hauls are rare or lacking in neuston collections. This net alone will not provide a representative sample of the fish larvae in a survey area. It should not be regarded as a primary tool, but a supplementary one with intriguing potentials.

#### REFERENCES

- Ahlstrom, Elbert H. 1959. Vertical distribution of pelagic fish eggs and larvae off California and Baja California. *Fish. Bull.*, U.S., 60: 107-146.
- . 1969. Distributional atlas of fish larvae in the California Current region: jack mackerel, *Trachurus symmetricus*, and Pacific hake, *Merluccius productus*, 1951 through 1966. *Calif. Coop. Oceanic Fish. Invest. Atlas No. 11*, xi + 187 pp.
- Ahlstrom, Elbert H., J. Isaacs, J. Thraillkill, and L. Kidd. 1958. High-speed plankton sampler. *Fish. Bull.*, U.S., 58: 187-214.
- Bieri, Robert. 1961. Post-larval food of the pelagic coelenterate, *Velella lata*. *Pac. Sci.*, 15: 553-556.
- Brock, Vernon E. 1940. Note on the young of the sablefish, *Anoplopoma fimbria*. *Copeia*, (4): 268-270.
- Davy, Brent. 1972. A review of the lanternfish genus *Taaningichthys* (Family Myctophidae) with description of a new species. *Fish. Bull.*, U.S., 70: 67-78.
- Farris, David A. 1961. Abundance and distribution of eggs and larvae and survival of larvae of jack mackerel (*Trachurus symmetricus*). *Fish. Bull.*, U.S., 61: 247-279.
- Fitch, John E., and Robert J. Lavenberg. 1968. Deep-water teleostean fishes of California. *Univ. Calif. Press, Berkeley*, 155 p.
- Hempel, G., and H. Weikert. 1972. The neuston of the subtropical and boreal northeastern Atlantic Ocean. A review. *Mar. Biol.*, 13(1): 70-88.
- Kobayashi, Kiyu. 1957. Larvae and young of the sable fish, *Anoplopoma fimbria* (Pallas), from the sea near the Aleutian Islands. *Bull. Jap. Soc. of Sci. Fish.*, 23(7 and 8): 376-382. [In Japanese, English abstract.]
- Moser, H. Geoffrey, and Elbert H. Ahlstrom. 1972. Development of the lanternfish, *Scopelopsis multipunctatus* Brauer 1906, with a discussion of its phylogenetic position in the family Myctophidae and its role in a proposed mechanism for the evolution of photophore patterns in lanternfishes. *Fish. Bull.*, U.S., 70: 541-564.
- . 1974. Role of larval stages in systematic investigations of marine teleosts: The Myctophidae, a case study. *Fish. Bull.*, U.S., 72: 391-413.

- Nellen, Walter. 1973. Untersuchungen zur Verteilung von Fischlarven und Plankton im Gebiet der Großen Meteorbank. "Meteor" Forsch.-Ergebnisse. Reihe D., 13: 47-69.
- Paxton, John R. 1972. Osteology and relationships of the lanternfishes (Family Myctophidae). Bull. Los Angeles County Mus. Nat. Hist. Sci., 13: 1-81.
- Smith, Paul E., Elbert H. Ahlstrom, and Harold D. Casey. 1970. The saury as a latent resource of the California Current. Calif. Coop. Oceanic Fish. Invest. Rep., 14: 88-130.
- Ueyanagi, Shoji, and Teiko Doi. 1971. Spawning area of the saury in the eastern Pacific Ocean in ecological study of pelagic fishery resources. Far Seas Fish. Res. Lab., Tuna Fish. Res. Council. Data: 45-49.

# OVARIAN DEVELOPMENT AND FECUNDITY OF FIVE SPECIES OF CALIFORNIA CURRENT FISHES

JOHN S. MacGREGOR

National Oceanic and Atmospheric Administration  
National Marine Fisheries Service  
Southwest Fisheries Center  
La Jolla, California 92038

## ABSTRACT

Four different types of ovarian development in five species of fishes are described. The size distribution of the developing eggs suggests that Pacific herring, *Clupea pallasii*, spawns one batch of eggs during its spawning season; *Vinciguerria lucetia* and Pacific saury, *Cololabis saira*, spawn more than once. The data for jack mackerel, *Trachurus symmetricus*, and Pacific mackerel, *Scomber japonicus*, proved to be inconclusive. The average number of eggs per gram of fish in a spawning batch was *V. Lucetia*, 456; *S. japonicus*, 264; *C. pallasii*, 277; *T. symmetricus*, 109; *C. saira*, 22.

## INTRODUCTION

One objective of the California Cooperative Fisheries Investigations (CalCOFI) is to estimate the biomasses of species of California Current fishes from censuses of eggs and larvae of these species. Among data necessary to make such estimates are the number of eggs spawned by the females of each species during the spawning season. This is the product of the number of eggs spawned at each spawning and the number of spawnings per season. Five species of California Current fishes were investigated with respect to types of ovarian development.

The Pacific saury, *Cololabis saira*, is found in the temperate North Pacific from Asia to North America. There is a commercial fishery for saury in the northwestern Pacific, but there is no American fishery. It is important prey species for the albacore, *Thunnus alalunga*, in the North Pacific accounting for 50% or more by volume of the albacore diet (McHugh, 1952; Graham, 1959; Iversen, 1962).

The jack mackerel, *Trachurus symmetricus*, is a commercially important fish in California. The catch reached a peak of 73,000 tons in 1952. Since then this has declined to about 24,000 to 30,000 tons (1968-72). The jack mackerel also is taken from time to time in the sport fishery.

The Pacific mackerel, *Scomber japonicus*, was a commercially important fish in California. In 1935, the catch peaked at 73,000 tons. The catch declined to 600 to 3,500 tons (1965-69), and a moratorium on commercial fishing was declared in 1970. In spite of the decline in commercial catch, the Pacific mackerel has remained an important sport fish for commercial partyboat sports fishermen in southern California.

*Vinciguerria lucetia* an isospondylid fish of the family Gonostomatidae, is one of the most abundant pelagic fishes taken as larvae in the eastern North Pacific Ocean by CalCOFI. In 1955-57, it was the fourth most abundant fish larva found in CalCOFI net tows. This species accounted for 6.2% of the total larvae taken (Ahlstrom, 1959), ranking only behind northern anchovy, *Engraulis mordax* (33.4%), Pacific hake, *Merluccius productus* (18.5%), and rockfishes, *Sebastes* spp. (7.5%). At the present time no fishery exists for this species.

Unlike the above three groups, *V. lucetia* larvae are more abundant in the southernmost part of the CalCOFI survey area and in the last half of the year, an area and time of reduced coverage by CalCOFI cruises in the three years 1955-57. Ahlstrom and Counts (1958) estimated the number of *V. lucetia* larvae in the CalCOFI survey area between 25° and 37° N latitude at  $19.5 \times 10^{12}$  in 1951, and  $19.0 \times 10^{12}$  in 1952. In addition, *V. lucetia* has a very extensive range outside of the CalCOFI area in the Pacific, Indian, and Atlantic Oceans.

Although it has no direct commercial value, *V. lucetia* is believed to be a significant item in the diets of valuable commercial and game fishes (Ahlstrom and Counts, 1958).

Pacific herring, *Clupea pallasii*, has no commercial or sportsfishing importance in southern California although it is an important commercial species farther to the north. It is included in this study because it illustrates a type of ovarian development different from those of the other four species of fish.

## MATERIALS AND METHODS

Fish were obtained from various CalCOFI collections. They were measured and weighed. Gonads were weighed to the nearest milligram and preserved in 3% formalin. Samples of ova were removed from developing ovaries, weighed, and spread with a drop of glycerin on a lined microscope slide. A second slide was lightly taped to the first slide as a cover.

Each slide was projected on a white-surfaced table at a magnification of 50× using a projector designed for scale reading. The diameters of enough yolked ova were measured to determine their size distribution. Additional ova from weighted samples were counted using either the projector or a binocular microscope to obtain an estimate of the number of ova in the ovary.

**SPAWNING SEASONS**

When the percent spawning by month is averaged over a number of years (Figure 1), we can obtain a general idea of when the spawning will probably occur. But in individual years the spawning is more concentrated in time, and the time of peak spawning may be much later or earlier than indicated by averaged data for several years.

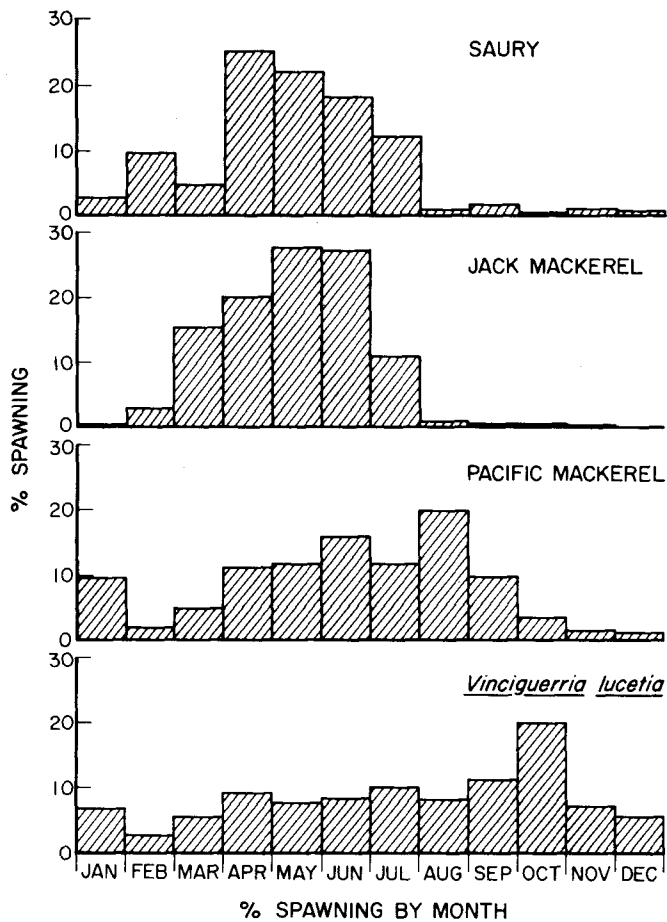

FIGURE 1. Average percent spawning by month. (A) Pacific saury based on standard haul totals of eggs for the years 1950 through 1959. (B) Jack mackerel based on standard haul totals of larvae for the years 1950 through 1959. (C) Pacific mackerel based on standard haul totals of larvae for the years 1951 through 1959. (D) *Vinciguerria lucetia* based on estimates of larval abundance for the years 1951 and 1952.

**Pacific Saury**

During the decade 1950-59, the 6 month periods of February through July accounted for 91% of the saury spawning (Figure 1A) as indicated by numbers of eggs taken in CalCOFI nets. But, in the individual years, the month of heaviest saury spawning occurred as early as February or as late as July, and an average of 63% of the spawning occurred in the 2 peak spawning months.

**Jack Mackerel**

Over the same time period, February through July accounted for 99% of the jack mackerel spawning as

measured by the presence of larvae in CalCOFI net tows (Figure 1B). The month of heaviest spawning varied from March to as late as July, and an average of 66% of the spawning occurred in the 2 months of heaviest spawning in individual years.

**Pacific Mackerel**

During the 9 years 1951-59, the 6 months, April through September accounted for 79% of the Pacific mackerel spawning as measured by numbers of larvae taken in CalCOFI nets (Figure 1C). Heaviest spawning occurred as early as January to as late as August. An average of 54% of the spawning occurred in the 2 months of heaviest spawning in individual years.

***Vinciguerria lucetia***

Based on the numbers of larvae taken in CalCOFI net tows during the 2 years 1951-52, the 6 months May through October, accounted for 65% of *V. lucetia* spawning (Figure 1D). The peak spawning month in both years was October, but only 33% of the spawning took place in the two heaviest spawning months of these 2 years.

*V. lucetia* and Pacific mackerel have a more southerly distribution than saury and jack mackerel, and they may spawn earlier in the year to the south of the area regularly sampled by CalCOFI.

**Pacific Herring**

The Pacific herring has a very short spawning season in mid-winter in San Diego Bay, which is the southern limit of its spawning range on the west coast of North America. The demersal eggs of herring are not taken in CalCOFI surveys, but data are included here because these fish illustrate a fourth type of ovarian development.

**RESULTS**

The two mackerels have similar ovarian development. In immature female fish or in those

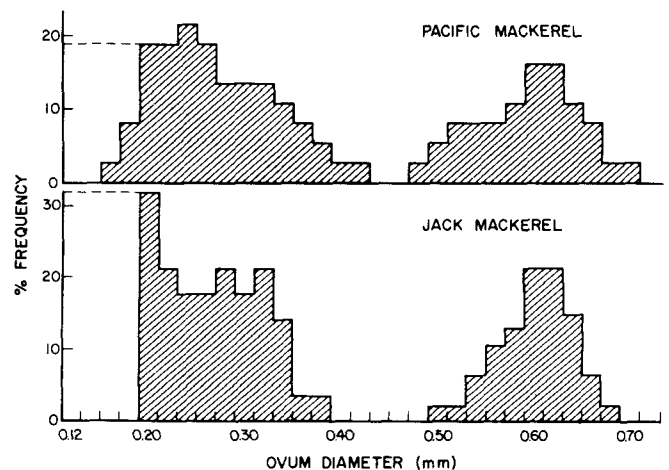

FIGURE 2. Frequency distribution of diameters of yolked eggs in the ovaries of (A) Pacific mackerel, and (B) jack mackerel.

with resting phase ovaries, only transparent eggs less than 0.20 mm in diameter are present. In the earliest stages of development, some of these eggs increase in size and become opaque as yolk material forms within the eggs.

A portion of these yolked eggs continues to grow and eventually forms a second distinct size group (Figure 2). The length of time that the opaque eggs are held at the prespawning stage may be prolonged until external conditions, such as water temperature, are suitable for spawning. Just before the onset of spawning these advanced eggs absorb water, roughly doubling their volume, and become translucent. A perivitelline space is formed enlarging the eggs even more.

Ahlstrom and Ball (1954) state that spawned jack mackerel eggs are 0.90 to 1.08 mm in diameter with a perivitelline space of 0.09 mm and yolk diameters of 0.68 to 0.88 mm (volume 0.16 to 0.26 mm<sup>3</sup>). Two jack mackerel in the samples that I examined contained eggs of this size (Table 1).

According to Kramer (1960) freshly spawned Pacific mackerel eggs are 1.06 to 1.14 mm diameter with a perivitelline space of 0.02 mm. Yolk diameters range from 1.02 to 1.10 mm diameter (volume 0.55 to 0.70 mm<sup>3</sup>).

The largest eggs (yolk diameters) found in Pacific

mackerel ovary samples ranged from 0.57 to 0.77 mm in diameter except for two specimens which contained translucent eggs in the 1.06 to 1.14 mm range. One of these fish appeared to be partly spawned, and the eggs were not counted. The other contained both the large translucent eggs and smaller opaque eggs in the 0.50 to 0.74 mm range. These smaller eggs were found only in the anterior third of the ovary away from the oviduct. An estimate of the opaque eggs in this size group was 130 per gram of fish while the translucent eggs numbered 115 per gram of fish. The total number of eggs per gram of fish was 245, which is lower than the 378 and 319 eggs per gram of fish in the two prespawning females from the same sample. The opaque eggs in the ovaries of this fish were undoubtedly part of the same spawning batch as the translucent eggs but had not yet absorbed water. I have found the same conditions in the ovaries of sardines taken from a school that was actively spawning.

The number of advanced eggs averaged 109 per gram of fish for the 30 jack mackerel examined (Table 1). However, for the 15 smaller fish (217 to 258 mm fork length), the number of eggs was only 66 per gram of fish, while for the 15 larger fish, 438 to 554 mm, it was 152 eggs per gram of fish.

TABLE 1  
Fecundity Data for 30 Jack Mackerel, *Thachurus symmetricus*.

Specimen number*	Fork length (mm)	Weight (grams)	Condition factor	Ovary weight (grams)	Gonad index	Advanced eggs		
						Size range (mm)	Number (thousands)	Number per gram of fish
1.....	217	109	106	2.2	2.0	.60-.77	5.1	47
2.....	225	124	109	2.1	1.7	.57-.67	5.2	42
3.....	225	116	102	3.3	2.8	.57-.70	10.3	89
4.....	230	139	114	3.5	2.5	.57-.70	9.9	71
5.....	230	136	112	3.4	2.5	.47-.63	9.9	73
6.....	232	122	98	2.1	1.7	.53-.70	.8	7
7.....	232	132	106	3.1	2.3	.50-.67	7.6	57
8.....	233	139	110	2.8	2.0	.57-.67	3.4	25
9.....	236	139	106	3.8	2.7	.57-.67	8.9	64
10.....	237	135	101	3.5	2.6	.50-.67	7.9	57
11.....	238	167	124	5.6	3.4	.53-.70	20.1	121
12.....	242	168	119	2.4	1.4	.57-.67	1.6	10
13.....	243	154	107	4.8	3.1	.53-.70	18.4	119
14.....	252	178	111	3.8	2.1	.47-.60	13.9	73
15.....	258	200	116	7.4	3.7	.57-.77	26.4	132
16.....	438	907	108	27.6	3.0	.47-.63	94.6	104
17.....	470	1149	111	59.5	5.2	.53-.70	263.	229
18.....	483	1214	104	48.1	4.0	.50-.67	236.	194
19.....	499	1382	111	49.9	3.6	.50-.67	246.	178
20.....	508	1410	108	50.6	3.6	.50-.70	199.	141
21.....	516	1416	103	52.3	3.7	.50-.70	150.	106
22.....	525	1547	107	59.2	3.8	.50-.67	251.	162
23.....	536	1443	94	40.4	2.8	.50-.67	173.	120
24.....	536	1802	117	62.3	3.5	.53-.70	226.	125
25.....	538	1772	114	72.2	4.1	.53-.70	314.	177
26.....	540	1722	109	120.0	7.0	.80-.90	159.	92
27.....	543	1718	107	141.8	8.3	.73-.97	192.	112
28.....	545	1636	101	83.6	5.1	.50-.70	437.	267
29.....	551	1793	107	65.5	3.7	.50-.63	251.	140
30.....	554	1785	105	70.9	4.0	.50-.70	245.	137

\* Specimens number 1-15 were taken 95 miles west of San Diego, May 25, 1970; number 16-17, 265 miles west of San Diego, May 7, 1969; number 18-25, 90 miles west southwest of San Diego, June 22, 1970; number 26-30, 6 miles west of San Diego, May 27, 1970. Condition factor equals weight of fish times 10<sup>7</sup> divided by fork length cubed. Gonad index equals gonad weight × 100 divided by fish weight.

TABLE 2  
Fecundity data for 18 Pacific Mackerel, *Scomber japonicus*.

Specimen number*	Fork length (mm)	Weight (grams)	Condition factor	Ovary weight (grams)	Gonad index	Advanced eggs		
						Size range (mm)	Number (thousands)	Number per gram of fish
1.....	273	267	131	6.7	2.5	.44-.60	37.7	141
2.....	280	358	163	33.3	9.3	.48-.66	163.7	457
3.....	291	286	116	10.2	3.6	.42-.58	63.1	220
4.....	314	362	117	21.9	6.0	.48-.70	136.8	378
5.....	326	375	108	17.0	4.5	.44-.64	119.8	319
6.....	343	475	118	30.4	6.4	.50-.74	146.6	309
7.....	328	471	133	35.4	7.5		132.1	281
8.....	328	493	140	30.7	6.2		127.4	258
9.....	333	509	138	22.7	4.5	.50-.67	123.7	243
10.....	335	501	133	26.5	5.3	.60-.73	96.3	192
11.....	341	545	137	27.0	5.0	.53-.73	104.7	192
12.....	341	573	145	36.5	6.4	.57-.77	235.0	410
13.....	342	545	136	36.8	6.8		152.8	280
14.....	345	541	132	28.0	5.2	.53-.70	116.0	214
15.....	346	555	134	33.4	6.0		127.4	230
16.....	350	573	134	23.0	4.0	.53-.67	93.5	163
17.....	353	602	137	36.0	6.0	.50-.67	181.8	302
18.....	379	727	134	34.5	4.7		112.6	155

\* Specimens number 1-2 were taken in the San Diego area, June 9, 1960; number 3, Hipolito Bay, August 11, 1958; numbers 4-5, San Diego area, June 14, 1957; number 6, Santa Catalina Island, June 5, 1957; number 7-8, 25° 44' N, 113° 08' W, January 11, 1970. Condition factor equals weight of fish times 10<sup>3</sup> divided by fork length cubed. Gonad index equals gonad weight × 100 divided by fish weight.

The number of advanced eggs averaged 264 per gram of fish for 18 Pacific mackerel (Table 2). There were no apparent changes in the number of eggs per gram of fish over the fork length range of 273 to 379 mm.

During the period of development through spawning, there was no indication of the formation and growth of a second mode of eggs from the mass of smaller yolked and non yolked eggs for either species of mackerel. The ratio of numbers of small yolked eggs to numbers of advanced eggs was 1.5:1.0 for the Pacific mackerel and 1.6:1.0 for the jack mackerel.

The ovaries of immature *V. lucetia* contain only transparent ova less than 0.20 mm diameter. As the ovary develops, a mode of dark yolked eggs is formed (Figure 3A). All of the eggs in this mode continue to grow until they are about 0.48 mm diameter at which time a second mode of dark yolked ova about equal in number to the advanced eggs is formed (Figure 3B, C, D, and E). This secondary mode of opaque eggs is present in fish that contain advanced translucent eggs (Figure 3F, G, and H) but shows little growth until after the advanced eggs have been spawned. This apparent lack of growth in the secondary mode probably results from the very rapid

TABLE 3  
Fecundity Data for 16 *Vinciguerria lucetia*.

Specimen number*	Standard length (mm)	Weight (grams)	Condition factor	Ovary weight (grams)	Gonad index	Advanced eggs		
						Size range (mm)	Number	Number per gram of fish
1.....	34	0.375	95	0.009	2.4	.40-.56	040	107
2.....	36	0.443	95	0.034	7.7	.52-.66	209	472
3.....	37	0.475	94	0.014	2.9	.30-.42	177	373
4.....	38	0.439	80	0.018	4.1	.36-.48	158	360
5.....	39	0.498	84	0.028	5.6	.54-.70	170	341
6.....	39	0.521	88	0.014	2.7	.38-.50	157	301
7.....	40	0.546	85	0.018	3.3	.30-.38	229	419
8.....	40	0.575	90	0.021	3.7	.38-.46	196	341
9.....	41	0.602	87	0.021	3.5	.36-.44	189	314
10.....	42	0.692	93	0.046	6.6	.50-.66	308	445
11.....	43	0.670	84	0.025	3.7	.22-.36	350	522
12.....	43	0.693	87	0.037	5.3	.54-.68	191	276
13.....	44	0.642	75	0.028	4.4	.36-.50	206	321
14.....	46	0.846	87	0.074	8.7	.54-.70	357	422
15.....	56	1.448	82	0.086	5.9	.32-.42	1,515	1046
16.....	56	1.678	96	0.092	5.5	.24-.44	2,064	1230

\* Specimens number 1-14 were taken at Guadalupe Island, May 25, 1952; numbers 15-16, 25° 29' N, 115° 24' W, August 10, 1953. Condition factor equals weight of fish times 10<sup>3</sup> divided by standard length cubed. Gonad index equals gonad weight × 100 divided by fish weight.

growth of the advanced eggs owing to water absorption.

Ahlstrom and Counts (1958) give the diameter of the newly spawned *V. lucetia* egg as 0.58 to 0.74 mm. However, they found that the size of the egg was related to water temperature. Eggs taken in water with a temperature of 16° C averaged 0.72 mm diameter. With increasing temperature, eggs became progressively smaller and averaged only 0.60 mm diameter in water at 28° C.

The 14 specimens of *V. lucetia* taken at Guadalupe Island (29° N lat) ranged in standard length from 34 to 46 mm and averaged 358 advanced eggs per gram of fish (range 107 to 522). The two specimens taken at CalCOFI Station 130.60 (25° 29½' N lat) were both 56 mm standard length and contained 1,046 and 1,230 eggs per gram of fish (Table 3) or about three times as many eggs per gram of fish as the smaller fish.

Although these two fish were taken farther to the south (and in August) than the 14 fish taken at Guadalupe Island (in May) when the water

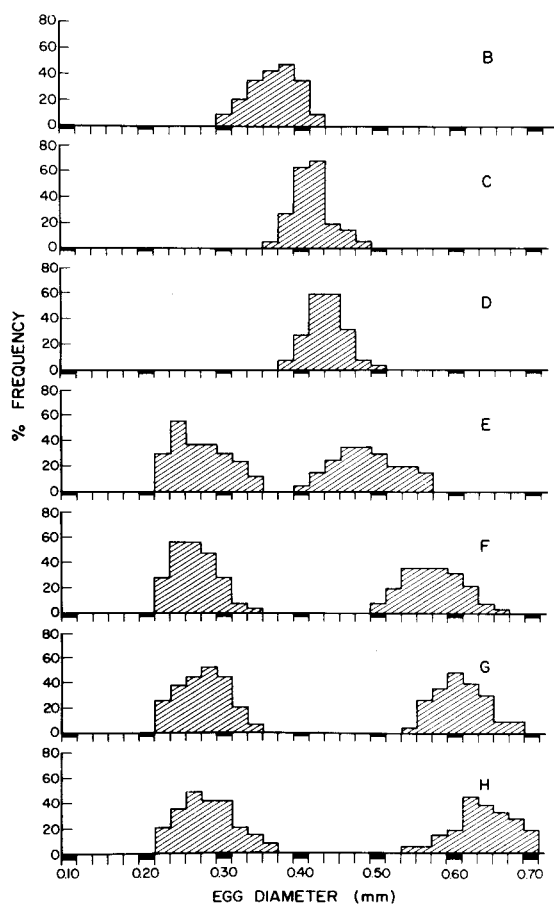

FIGURE 3. Frequency distributions of diameters of yolked eggs in the ovaries of *Vinciguerria lucetia*. (A, B, C, and D) Only the developing mode of yolked eggs (and small nonyolked eggs less than 0.20 mm in diameter) are present during earlier stages of development. (E, F, G, and H) As the advanced eggs develop a second size mode of eggs about equal in number to the advanced mode develops. This second mode of yolked eggs shows little growth as the advanced mode develops to the translucent spawning stage (H).

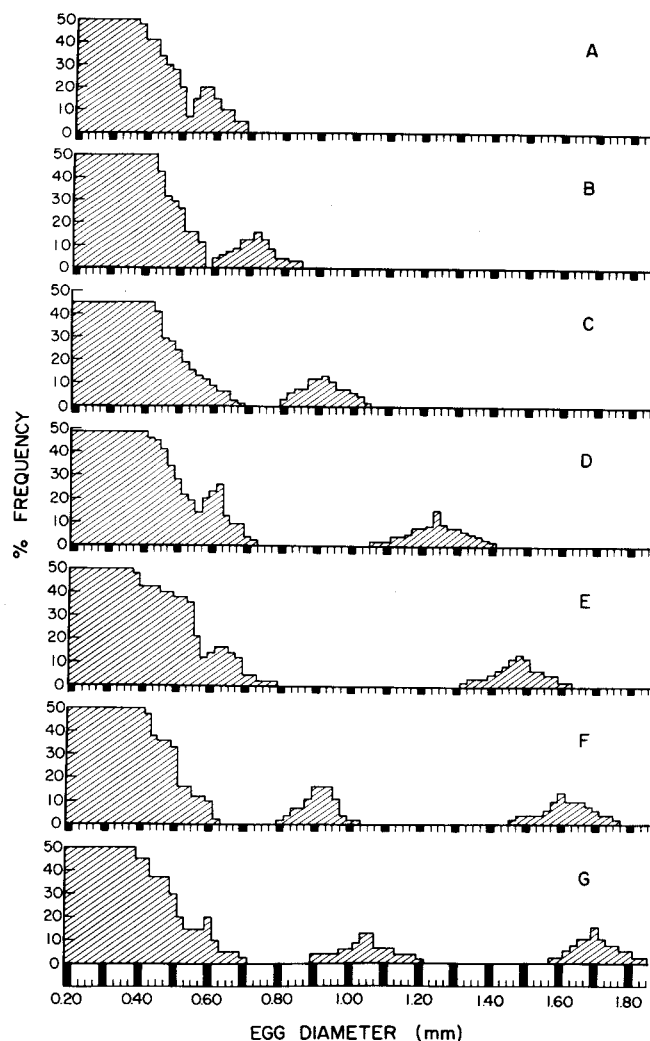

FIGURE 4. Frequency distribution of diameters of yolked eggs in the ovaries of the Pacific saury. At all stages of development a numerous mode of very small yolked eggs is present. (A, B, and C) The smaller group of eggs to be spawned becomes separated from these very small yolked eggs by size during their early development. (D, E) A second mode of eggs about equal in number to the advanced mode begins to develop as the advanced eggs increase in size, and (F, G) becomes completely differentiated by size from the mass of small yolked eggs as the advanced eggs continue to grow and eventually become translucent.

temperature was undoubtedly higher, the size difference in spawned eggs related to temperature cannot account for the great difference in fecundity. Probably the fecundity increases more rapidly proportionately to weight as the fish grows. This seems to be true also of the jack mackerel.

Pacific saury ovaries are elongate and cylindrical. In the immature ovaries of female fish the ova are transparent and less than 0.20 mm diameter. As the fish matures the ova increase in size and darken with yolk formation.

A group of these eggs becomes a distinct size mode and continues to increase in size (Figure 4A, B, and C). As these advanced eggs continue to grow, a second mode becomes distinguishable from the mass

TABLE 4  
Fecundity Data for 16 Pacific Sauries, *Cololabis saira*.

Specimen number*	Standard length (mm)	Weight (grams)	Condition factor	Ovary weight (grams)	Gonad index	Advanced eggs		
						Size range (mm)	Number	Number per gram of fish
1.....	191	27.9	41	0.76	2.7	0.84-1.04	813	29
2.....	220	46.7	44	2.09	4.5	1.04-1.38	1314	28
3.....	247	69.9	46	6.63	9.5	1.34-1.74	2188	31
4.....	252	76.7	48	2.25	2.9	0.82-0.96	1761	23
5.....	269	88.7	46	6.31	7.1	1.34-1.60	2209	25
6.....	195	30.4	41	0.96	3.1	1.14-1.64	686	23
7.....	198	32.3	42	1.13	3.5	1.04-1.42	724	22
8.....	199	31.6	40	0.59	1.9	0.80-1.04	657	21
9.....	202	32.0	39	0.88	2.7	0.96-1.26	520	16
10.....	202	34.3	42	1.38	4.0	1.08-1.38	1016	30
11.....	203	35.4	42	1.94	5.5	1.48-1.90	(323)**	(15)**
12.....	207	36.1	41	0.68	1.9	0.76-1.24	542	15
13.....	208	37.2	41	2.11	5.7	1.56-1.90	(411)**	(11)**
14.....	184	25.0	40	0.40	1.6	0.82-1.16	225	9
15.....	215	47.0	47	2.07	4.4	1.58-1.84	(211)**	(4)**
16.....	281	100.1	45	3.20	3.2	1.50-1.88	1142	11

\* Specimen number 1 was taken 100 miles south of San Diego, January 18, 1954; numbers 2-5, off Point Loma, San Diego, February 20, 1950; numbers 6-13; Sebastián Viscaño Bay, March 8, 1954; numbers 14-15, Sebastián Viscaño Bay, March 8, 1954; number 16, Cortes Bank, October 3, 1949. Condition factor equals weight of fish times  $10^3$  divided by standard length cubed. Gonad index equals gonad weight  $\times$  100 divided by fish weight.

\*\* Partly spawned.

of smaller opaque eggs (Figure 4D, E). This second mode also becomes a distinct size mode as the first group of eggs approaches maturity (Figure 4F, G). The first mode becomes translucent at 1.50 to 1.90 mm diameter.

When the eggs absorb water and become translucent, they are expelled into the lumen of the cylinder-like ovary. The eggs are held together in a string by sticky filaments at this point. They are spawned in this condition, although the eggs break off into shorter strings during spawning activities.

For 13 Pacific sauries the number of eggs per gram of fish averaged 22 (Table 4; excluding the three fish that were partly spawned). The number of eggs in an advanced mode was approximately equal to the number in a distinct second mode when it was present. The number of small opaque eggs averaged 10 times as many as were in the advanced mode and ranged widely from 3 times to 16 times as many.

Five female Pacific herring taken from San Diego Bay were in prespawning condition. The ovaries of

each of these fish contained small transparent eggs less than 0.20 mm diameter and one group of large yolked eggs (Table 5). There were no small or intermediate sized, yolked eggs.

#### DISCUSSION

Some inferences may be drawn from the size distributions of eggs in the ovaries of fishes. It is generally agreed that the herring spawns only one batch of eggs, and in herring containing advanced eggs, this group is the only group of yolked eggs in the ovary. Observations of spawning and the relatively short spawning season in any one locality tend to confirm this conclusion.

The ovaries of most species of maturing marine fishes, however, appear to contain distributions of egg sizes somewhat similar to those of the two mackerels. There is some controversy among investigators as to whether only the advanced group of yolked eggs or all yolked eggs are spawned during one spawning season.

TABLE 5  
Fecundity Data for Five Pacific Herring, *Clupea pallasii*.

Specimen number*	Standard length (mm)	Weight (grams)	Condition factor	Ovary weight (grams)	Gonad index	Advanced eggs		
						Size range (mm)	Number	Number per gram of fish
1.....	153	53	148	9.27	18.5	1.14-1.36	8,463	160
2.....	166	75	164	14.65	19.5	1.02-1.24	18,168	242
3.....	168	67	141	15.97	23.8	1.16-1.38	16,621	248
4.....	168	84	177	20.15	24.0	1.12-1.30	20,600	245
5.....	169	87	180	26.96	31.0	1.24-1.50	20,918	240

\* Five specimens were taken from San Diego Bay, January 1956. Condition factor equals weight of fish times  $10^3$  divided by standard length cubed. Gonad index equals gonad weight  $\times$  100 divided by fish weight.



The most generally held assumption seems to be that because the small eggs do form yolk, they will continue to develop and eventually be spawned as secondary and tertiary spawning batches. But, as the ovarian development of *V. lucetia* demonstrates, a discrete secondary spawning batch of eggs can readily develop directly from the nonyolked oocytes. The lengthy spawning season of this species and the fact that the secondary mode develops during the growth of the advanced mode and approximately equals it in the number of ova present are evidence that *V. lucetia* spawns more than once during the spawning season.

Ovary development of the Pacific saury resembles that of most marine fishes in that a large group of oocytes develop into small, yolked eggs, and from this group a smaller number of eggs continue to increase in size and develop into a spawning batch. The saury differs from most other species in that a discrete secondary batch of eggs about equal in number to the advanced group begins to develop before the advanced group is spawned. Further evidence of multiple spawning in this species is demonstrated in saury #4 (Table 4) which, in addition to the advanced group of eggs 0.82 to 0.96 mm in diameter, contained two large eggs approximately 1.80 mm in diameter remaining from a previous spawning.

The California grunion, *Leuresthes tenuis*, which spawns on the beaches of southern California and Baja California during the nighttime high tides accompanying the new and full moons is known to be a multiple spawner. This species has a distribution of eggs in the ovaries very similar to that of the saury. In the ovaries of a female grunion (134 mm standard length, 23½ grams) I found 12 large eggs 1.5 to 1.6 mm in diameter remaining from a previous spawning, a discrete group of 1,775 advanced eggs 0.68 to 0.90 mm in diameter, and 5,680 smaller, yolked eggs 0.20 to 0.64 mm in diameter. The larger eggs in this latter group were beginning to form a discrete size mode.

Two other atherinids, the topsmelt, *atherinops af-finis*, and the jack smelt, *Atherinopsis californiensis*, also have this type of egg distribution in the developing ovaries. Clark (1929) reports finding a few ripe eggs in the lumen of the ovaries of jack smelt that contained developing modes of eggs indicating multiple spawning.

For species of fishes having size distributions of eggs in the ovaries similar to the mackerels, there is no good evidence for multiple spawning. When a few large eggs indicating previous spawning are present in the ovaries, the distribution of small, yolked eggs is much as it is when the advanced mode of eggs is present in the ovaries. No discrete size mode is present indicating that some of the small eggs have developed a new spawning group. Atresia of the

smaller eggs is often evident, but until it becomes widespread, the eggs may be classified as developing merely because they contain yolk. The evidence for multiple spawning in species having this kind of ovarian egg size distribution is inconclusive.

### SUMMARY

The five species of fishes reported on here illustrate four types of ovarian development. These four types are distinguished by the numbers and size distribution of yolked eggs present in the developing ovaries. The ovaries of all five species contained small transparent eggs containing no yolk material and less than 0.20 mm in diameter.

The prespawning ovaries of the herring contained only these small transparent eggs and the advanced eggs. The prespawning ovaries of *V. lucetia* contained an intermediate mode of developing yolked eggs in addition to the advanced group. The prespawning ovaries of the two mackerels contained a group of small, yolked eggs that is a size continuation of the smaller, nonyolked eggs in addition to the advanced eggs, but there was no intermediate mode of developing eggs. The prespawning ovaries of the Pacific saury contained small, intermediate, and large opaque eggs.

The ratios of small to intermediate to large, yolked eggs for the five species was:

Pacific herring	0.0:0.0:1.0
<i>V. lucetia</i>	0.0:1.0:1.0
Pacific mackerel	1.5:0.0:1.0
jack mackerel	1.6:0.0:1.0
Pacific saury	10.0:1.0:1.0

The data indicate Pacific herring spawn one batch of eggs each season, while Pacific saury and *V. lucetia* spawn more than once. The data for Pacific mackerel and the jack mackerel are inconclusive on this point.

The average number of eggs in the advanced mode per gram of adult female fish was:

Species	Number of fish	Eggs per gram of fish
<i>V. lucetia</i>	16	456
Pacific mackerel	18	264
Pacific herring	5	227
jack mackerel	30	109
Pacific saury	13	22

However, the number of eggs per gram of fish varied considerably. Small fish tended to have much lower relative numbers of eggs than larger fish. This was especially true in *V. lucetia* where 14 small specimens averaged 358 eggs per gram of fish while two large specimens averaged 1,138 eggs per gram of fish, and in the jack mackerel where 15 smaller specimens averaged 66 eggs per gram of fish while 15 larger specimens averaged 152 eggs per gram of fish.

## REFERENCES

- Ahlstrom, E. H. 1959. Sardine eggs and larvae and other fish larvae Pacific coast, 1957. U.S. Fish Wildl. Serv., Spec. Sci. Rept., Fish., 328: 1-99.
- Ahlstrom, E. H., and O. P. Ball. 1954. Description of eggs and larvae of jack mackerel (*Trachurus symmetricus*) and distribution and abundance of larvae in 1950 and 1951. U.S. Fish Wildl. Serv., Fish., Bull., 56(97): 209-245.
- Ahlstrom, E. H., and R. C. Counts. 1958. Development and distribution of *Vinciguerria lucetia* and related species in the eastern Pacific. U.S. Fish Wildl. Serv., Fish. Bull., 58(139): 363-416.
- Clark, F. N. 1927. The life history of the California jacksmelt, *Atherinopsis californiensis*. Calif. Div. Fish and Game, Fish. Bull., (15): 1-23.
- Graham, J. J. 1959. Northeastern Pacific albacore survey Part I. Biological observations. U.S. Fish Wildl. Serv., Spec. Sci. Rept., Fish., 310: 1-33.
- Iversen, R. T. B. 1962. Food of albacore tuna, *Thunnus germon* (Lacepede), in the central and northeastern Pacific. U.S. Fish Wildl. Serv., Fish. Bull., 62(214): 45-481.
- Kramer, D. 1960. Development of eggs and larvae of Pacific mackerel and distribution and abundance of larvae 1952-56. U.S. Fish Wildl. Serv., Fish. Bull. 60(174): 393-438.
- McHugh, J. L. 1952. The food of albacore (*Germo alalunga*) off California and Baja California. Bull. Scripps Inst. Oceanogr., Univ. Calif. 6(4): 161-172.

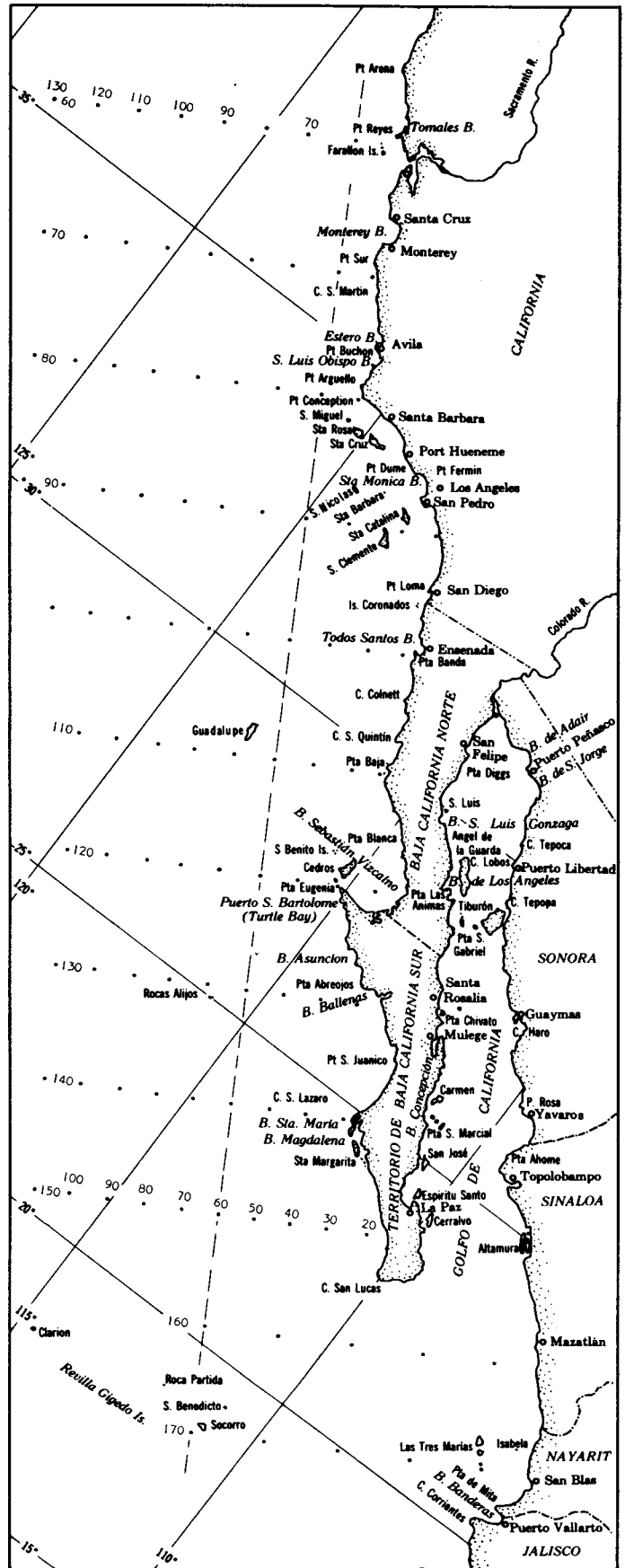
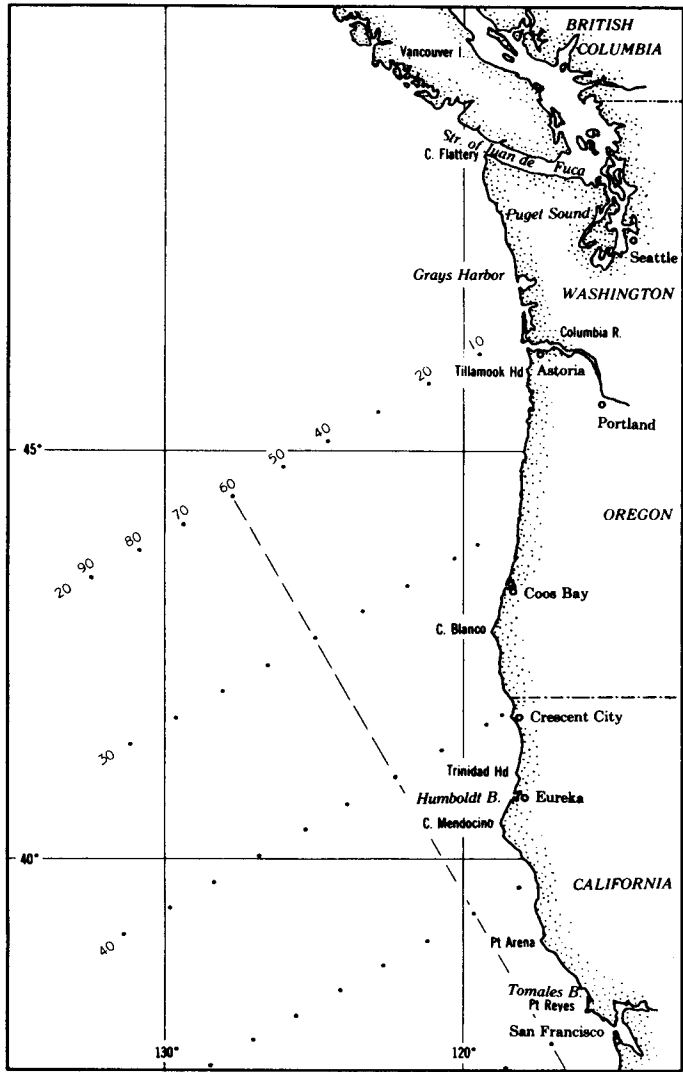

These maps are designed to show essential details of the area most intensively studied by the California Cooperative Oceanic Fisheries Investigations. This is approximately the same area as is shown in color on the front cover. Geographical place names are those most commonly used in the various publications emerging from the research. The cardinal station lines extending southwestward from the coast are shown. They are 120 miles apart. Additional lines are utilized as needed and can be as closely spaced as 12 miles apart and still have individual numbers. The stations along the lines are numbered with respect to the station 60 line, the numbers increasing to the west and decreasing to the east. Most of them are 40 miles apart, and are numbered in groups of 10. This permits adding stations as close as 4 miles apart as needed. An example of the usual identification is 120.65. This station is on line 120, 20 nautical miles southwest of station 60.

The projection of the front cover is Lambert's Azimuthal Equal Area Projection. The detail maps are a Mercator projection. Art work by George Mattson, National Marine Fisheries Service.

## CONTENTS

I. Review of Activities of 1 July 1973 to 30 June 1975.....	5
Report of the CalCOFI Committee.....	5
Agency Reports.....	6
Review of the Pelagic Wet Fisheries for 1973 and 1974.....	21
Publications .....	23
II. Symposia of the CalCOFI Conference	
San Clemente, November 4-7, 1973	
A. Fishery Science: Fact, Fiction, and Dogma.	
Catch-per-Unit-of-Effort: Fact, Fiction, and Dogma. <i>John Radovich</i> .....	31
Fishery Science: Fact, Fiction, and Dogma. <i>John D. Isaacs</i> .....	34
Fishery Science: Fact, Fiction, and Dogma. <i>Brian J. Rothschild</i> .....	44
Panel Discussion. <i>Herbert W. Frey</i> moderator, <i>John D. Isaacs, John Radovich, and Brian J. Rothschild</i> , panel members.....	45
B. Oceanography and Fisheries of Baja California Waters.	
Hidrología del Alto Golfo de California—I. Condiciones Durante Otoño. <i>Saúl Alvarez Borrego and Luis Arnulfo Galindo Bect</i> .....	51
Hidrología de la Bahía de San Quintín, Baja California, en Invierno y Primavera. <i>Amelia Guadalupe Chávez de Nishikawa and Saúl Alvarez Borrego</i> .....	60
Concentración de DDT y sus Metabolitos en Especies Filtradores y Sedimentos en el Valle de Mexicali y Alto Golfo de California. <i>J. Guardado Puentes</i> .....	73
Elementos Sobre la Distribución de Turbidez en el Alto Golfo de California. <i>Guadalupe Garcia de Ballesteros and Michel Larroque</i> .....	81
C. Scientific Contributions	
On Biology of the Market Squid, <i>Loligo opalescens</i> , a Contribution Toward the Knowledge of Its Food Habits and Feeding Behavior. <i>Anatole S. Loukashkin</i> .....	109
Deep Scattering Layers: Patterns in the Pacific. <i>Sargun A. Tont</i> .....	112
Benthic Oceanography and the Distribution of Bottom Fish Off Los Angeles. <i>Alan J. Mearns and Lucinda Smith</i> .....	118
III. Symposia of the Cal COFI Conference	
Santa Barbara, November 12-14, 1974	
Roles of Phytoplankton in Marine Food Webs. <i>Richard W. Eppley</i> .....	125
An Experimentalist's View of Zooplankton Models. <i>Michael M. Mullin</i> ..	132
Density Dependence of Catchability Coefficient in the California Pacific Sardine, <i>Sardinops sagax caerulea</i> , Purse Seine Fishery. <i>Alec D. MacCall</i> .....	136
Sonar Mapping in the California Current Area: A Review of Recent Developments. <i>Rodger Hewitt</i> .....	149
California Undercurrent in the Southern California Bight. <i>Mizuki Tsuchiya</i> .....	155
Sediment Trap Applications in the Nearshore Region. <i>Floyd K. Mitchell</i>	159
Trace Element Anomalies in Marine Organisms off Southern California. <i>David R. Young and Dierdre J. McDermott</i> .....	162
Report of Neuston (Surface) Collections Made on an Extended CalCOFI Cruise During May 1972. <i>Elbert H. Ahlstrom and Elizabeth Stevens</i>	167
IV. Scientific Contributions	
Ovarian Development and Fecundity of Five Species of California Current Fishes. <i>John S. MacGregor</i> .....	181